

ERKADO

doors are our world



CATALOGUE
2022

EN

Edition I/2022/A
valid from 01.03.2022



ERKADO

doors are our world

Every house is fitted with interior doors. This is why thinking about doors from the perspective of their functional and practical features has long been insufficient. Underlining the best qualities in a perfectly furnished house, today they are an important component of interior design. For this reason, we create modern solutions, introduce attractive design and focus on the quality of workmanship to let you enjoy the choice of the Erkado doors.

We are committed to developing all business areas relevant for creating a product that meets your expectations. We achieve this goal by investing in technologically advanced production lines, staff training and systematic analysis of consumer needs. Our dynamic development would be impossible without the activity of the sales network participants. Thank you for your inspiring suggestions and friendly feedback.



The mark of responsible forestry
Look for FSC® certified products

CONTENTS

STILE DOORS	6
MISKANT	6
LAURENCJA	8
NEMEZJA NEW	10
ORCHIDEA NEW	12
BUDLEJA	14
EPIMEDIUM	16
ARALIA, NOLINA, EWODIA	18
POWOJNIK	20
MAGNOLIA	22
JUKA BEST PRICE!	24
FORSYCJA BEST PRICE!	26
LAWENDA BEST PRICE!	28
IRYS	30
DAGLEZJA	32
FREZJA	34
DEBECJA	36
SURMIA	38
BERBERYS	40
FLOKS	42
KROKUS	44
KAMELIA	46
PETUNIA	48
AZALIA	50
HIACYNT	52
FRAGI	54
GRAF GLASS DOORS	56
DECORATIVE LAMELLAS NEW	58
LACQUERED DOORS	60
BALDUR	60
MISKANT	62
NEMEZJA NEW	64
LAURENCJA	66
ANUBIS	68
UNO PREMIUM	70
TURAN	72
MILDA	74
SYLENA	76
INLAYS NEW	78
FLUSH DOORS	82
BALDUR	82
UNO PREMIUM	86
ALTAMURA	88
ANSEDONIA	90
LORIENT	92
MENTON	94
SORANO	96
INTERIOR FRONT DOORS	98
FORTECA RC2	98
FORTECA RC3	98
FIXED DOOR FRAME FOR FORTECA	102
STEEL DOOR FRAMES FOR FORTECA	103
HERSE SET	104
HERSE MAX SET	108
FIXED AND ADJUSTABLE DOOR FRAME FOR THE HERSE SET SERIES	110
STEEL DOOR FRAMES FOR THE HERSE SET SERIES	112
UNITED STEEL DOOR FRAME FOR THE HERSE SET SERIES	113
INTERIOR FIRE PROTECTION FRONT DOORS	114
LEDA EI30	114
LEDA EI60	114
WOODEN DOOR FRAME FOR THE LEDA SERIES	116
STEEL DOOR FRAMES FOR THE LEDA SERIES	116
DOUBLE-LEAF LEDA EI30 & EI60	117
HYPERION EI30 RC2	118
HARDWARE – HANDLES NEW	120
TECHNICAL INFORMATION	128
DOOR FRAME EXTENSION PANELS	134
WALL-MOUNTED SLIDING DOOR SYSTEMS	135
POCKET SLIDING DOOR SYSTEMS	141
DOUBLE-LEAF DOORS	144
FOLDING DOORS	147
COVERT CONCEALED DOOR SYSTEM	148
LIGHTING	151
DOOR FRAMES	153
TUNNEL TYPE ADJUSTABLE DOOR FRAME	156
STEEL DOOR FRAME	157
ADJUSTABLE CASING FRAME FOR STEEL DOOR FRAMES	158
REVERSE DOOR FRAME	159
ADJUSTABLE DOOR FRAME FOR NON-REBATED DOORS	160
FIXED FRAME FOR REBATED DOORS	161
ADJUSTABLE DOOR FRAME FOR NON-REBATED DOORS	162



DECORS

COLOURS AVAILABLE FOR INTERIOR DOORS

GREKO, FINISH



GOLDEN GREKO OAK

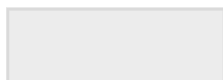

WHITE GREKO
(similar to: RAL 9010, NCS S 0502-Y50R)



GREKO ELM



GREKO GREY OAK



SANREMO GREKO



GREKO WALNUT



GREKO OAK



MEDIUM GREKO OAK



GREKO SONOMA



GREKO WHITE PINE



SNOW-WHITE GREKO
(similar to: RAL 9016, NCS S 0300-N)



LIGHT ACACIA FINISH

PREMIUM



WALNUT PREMIUM



GREY MAPLE PREMIUM



OAK PREMIUM

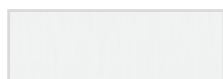

WHITE BARK PREMIUM

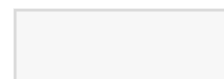

WHITE PREMIUM
(similar to: RAL 9003, NCS S 0500-N)



CONCRETE PREMIUM



GRAPHITE ASH PREMIUM



NATUR OAK PREMIUM



NEW
NATUR OAK PREMIUM HORIZONTAL¹⁾

CPL



OAK ST CPL



GREY OAK ST CPL



VENGE ST CPL



GREY PINE ST CPL



NEW
WHITE ST CPL¹⁾
(similar to: RAL 9003, NCS S 0500-N)



NEW
CAPPUCCINO ST CPL¹⁾
(similar to: RAL D2 080 80 05, NCS S3005-Y50R)



NEW
LIGHT-GREY ST CPL¹⁾
(similar to: RAL 7037, NCS S 5500-N)



NEW
BLACK ST CPL¹⁾
(similar to: RAL 9011, NCS S 9000-N)

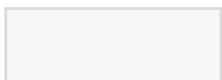

WHITE CPL 0.2 & 0.7
(similar to: RAL 9003, NCS S 0300-N)



ASH GREY CPL 0.2 & 0.7
(similar to: RAL 7047, NCS S 2500-N)



ANTHRACITE CPL 0.2 & 0.7
(similar to: RAL D2 000 35 00 NCS S 7000-N)



OAK CPL 0.2 & 0.7

UV-PAINTED

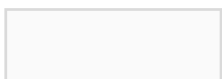

WHITE TITANIUM UV
(similar to: RAL 9003, NCS S 0500-N)

Read more on decors on p. 129

* Special **AntiFinger** **NEW** coating to reduce dirt and fingerprints

¹⁾ Available as of 01/04/2022



STILE DOORS

REBATED AND NON-REBATED



Solid 35 mm or 22 mm thick rail



Aesthetic frameless tongue-and-groove glazing without bars



Attractive GREKO laminate, resistant CPL surface or PREMIUM laminate which is both good-looking and durable



RUMBA handle with antibacterial coating containing active silver ions (optional)



Solid dowel joint



Free factory through hole drilling for handles (split handles) if ordered together with the leaf



Three adjustable 2-pin hinges set in a robust 40 mm thick stile (optional sleeves)



Modern tempered and frosted or optionally: transparent and novel VSG glass: mat or black

NEW



Drop-down gasket (alternatively)



MDF stile for the GREKO and CPL laminates with the AntiFinger coating **NEW**



Glulam wood stile for the PREMIUM and CPL laminates without the AntiFinger coating



Concealed magnetic stop (optionally) **NEW**



MISKANT

REBATED AND NON-REBATED INTERIOR STILE DOOR LEAVES



MISKANT 2, decor: BLACK ST CPL, black matt BELLA slim handle



MISKANT 1



MISKANT 2



MISKANT 3



MISKANT 4



MISKANT 5



MISKANT 6

MISKANT 4, decor NATUR OAK PREMIUM handle CUBE



CONSTRUCTION

- rebated or non-rebated door leaf made in the STILE technology
- MDF board vertical stiles covered with the GREKO and CPL laminate with the AntiFinger **NEW** coating and vertical glulam stiles covered with thin HDF panels and the PREMIUM or CPL laminate without the AntiFinger coating
- optionally, upon extra charge, upper panels extending the frame – page 134

HARDWARE

- rebated door leaves: three silver 2-pin hinges adjusted horizontally
- three concealed hinges in a non-rebated leaf, silver (optionally black - subject to an additional charge); hinges supplied with and included in the price of the door frame
- deadbolt lock in a rebated door leaf and a key-locked magnetic lock in a non-rebated door leaf, thumb turn cylinder, economy, with a silver blockade; optionally, for an additional charge, a black, magnetic lock

GLAZING

- tempered frosted glass (MISKANT 2, 4, 6) or clear glass (MISKANT 1, 3, 5), thickness 4 mm
- possibility to change the glazing side to REVERSE (OBVERSE - standard glazing)
- black lines of 18 mm in width (thickness)

AVAILABLE SOLUTIONS (p. 135-143)

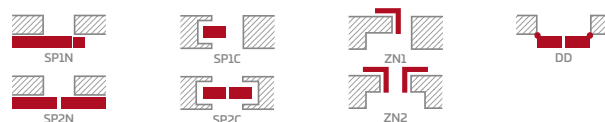

AVAILABLE DOOR LEAF WIDTHS



assembly film MISKANT 2:
<https://youtu.be/habWXyCI98c>



EXTRA CHARGES

free of charge factory drilled through holes for the handles (split handles) ordered in the package with the leaf **NEW**

ventilation cut

plastic woodgrain sleeves (4 pcs)

round or square metal sleeves (4 pcs); brushed nickel, patina, black or white

ventilation grille (only for door leaf widths of 80, 90, 100)

“100” rebated and non-rebated door leaf

metal hinge casings in the rebated door leaf (brushed nickel, patina, polished chrome, polished brass, white or black)

drop-down gasket ²⁾

can be replaced with a black magnetic lock for non-rebated door leaves

magnetic stop (buffer) ²⁾ **NEW**
(available in six colours p. 132)

STANDARD “OBVERSE” GLAZING



“REVERSE” GLAZING MADE TO ORDER



GREKO

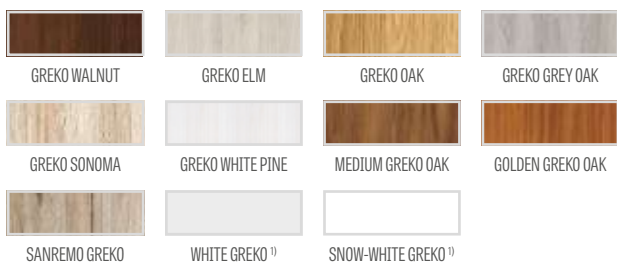

PREMIUM

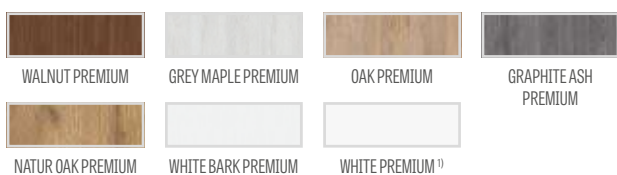

CPL

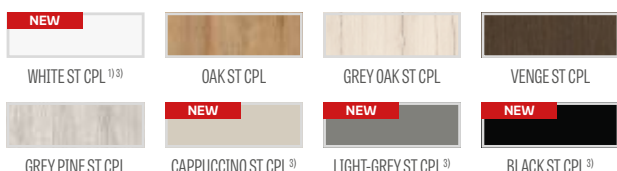

MDF stile for the GREKO and CPL laminates with the AntiFinger coating **NEW** | Glulam wood stile for the PREMIUM and CPL laminates without the AntiFinger coating

¹⁾ plain white laminate imitating a painted surface

²⁾ a stop prevents application of a drop-down gasket and vice versa

³⁾ special AntiFinger **NEW** coating to reduce dirt and fingerprints



LAURENCJA

REBATED AND NON-REBATED INTERIOR STILE DOOR LEAVES



LAURENCJA 1, PREMIUM WHITE decor, black VSG glass, CUBE PREMIUM handle, black matt



LAURENCJA 1



LAURENCJA 2



LAURENCJA 3



LAURENCJA 4



LAURENCJA 5



LAURENCJA 6

LAURENCJA 1 with PREMIUM WHITE laminate, black CUBE PREMIUM handle and black VSG 221 laminated glass



CONSTRUCTION

- rebated or non-rebated door leaf made in the STILE technology
- MDF board vertical stiles covered with the CPL laminate with the AntiFinger **NEW** coating and vertical glulam stiles covered with thin HDF panels and the PREMIUM or CPL laminate without the AntiFinger coating
- 4mm thick HDF panels with CPL or PREMIUM laminate
- very wide crossbar - 35 mm
- optionally, upon extra charge, upper panels extending the frame - page 134

HARDWARE

- rebated door leaves: three silver 2-pin hinges adjusted horizontally
- three concealed hinges in a non-rebated leaf, silver (optionally black - subject to an additional charge); hinges supplied with and included in the price of the door frame
- deadbolt lock in a rebated door leaf and a key-locked magnetic lock in a non-rebated door leaf, thumb turn cylinder, economy, with a silver blockade; optionally, for an additional charge, a black, magnetic lock

GLAZING

- standard 4 mm clear or milk tempered glass and for an additional charge VSG 221 milk glass or black safety glass, smooth on both sides
- possibility to change the glazing side to REVERSE (OBVERSE - standard glazing)

AVAILABLE SOLUTIONS (p. 135-143)

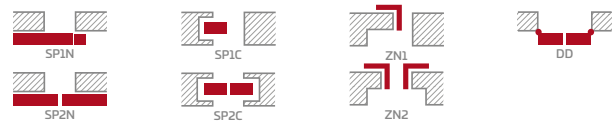

AVAILABLE DOOR LEAF WIDTHS

60 70 80 90 100

EXTRA CHARGES

free of charge factory drilled through holes for the handles (split handles) ordered in the package with the leaf **NEW**

ventilation cut

plastic woodgrain sleeves (4 pcs)

round or square metal sleeves (4 pcs); brushed nickel, patina, black or white

ventilation grille (only for door leaf widths of 80, 90, 100)

"100" rebated and non-rebated door leaf

frosted or black VSG 221 laminated safety glass, smooth on both sides

metal hinge casings in rebated door leaf (colour: brushed nickel, patina, glossy chrome, glossy brass, white or black)

drop-down gasket ²⁾

can be replaced with a black magnetic lock for non-rebated door leaves

magnetic stop (buffer) ²⁾ **NEW**
(available in six colours p. 132)

PREMIUM

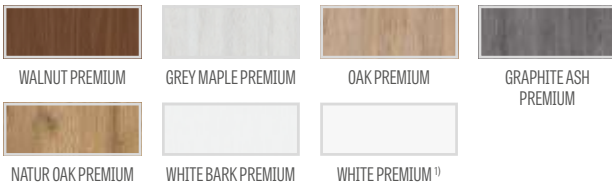

CPL

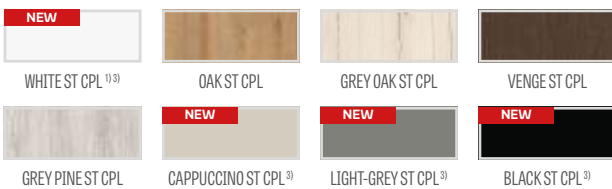

MDF stile for CPL laminates with the AntiFinger coating **NEW**



Glulam wood stile for the PREMIUM and CPL laminates without the AntiFinger coating

¹⁾ plain white laminate imitating a painted surface

²⁾ a stop prevents application of a drop-down gasket and vice versa

³⁾ special AntiFinger **NEW** coating to reduce dirt and fingerprints



NEMEZJA

REBATED AND NON-REBATED INTERIOR STILE DOOR LEAVES



NEMEZJA 6, decor WHITE PREMIUM, glossy brass BELLA slim handle



NEMEZJA 1



NEMEZJA 4



NEMEZJA 6



NEMEZJA 7



NEMEZJA 8



NEMEZJA 9



NEMEZJA 10



NEMEZJA 11



NEMEZJA 12



NEMEZJA 13

NEMEZJA 14 with WHITE PREMIUM laminate and a black CUBE PREMIUM handle



CONSTRUCTION

- rebated or non-rebated door leaf made in the STILE technology
- MDF board vertical stiles covered with the GREKO and CPL laminate with the AntiFinger **NEW** coating and vertical glulam stiles covered with thin HDF panels and the PREMIUM or CPL laminate without the AntiFinger coating
- bevelled 16 mm thick HDF panels with a selection of GREKO, CPL or PREMIUM laminate
- optionally, upon extra charge, upper panels extending the frame – page 134

HARDWARE

- rebated door leaves: three silver 2-pin hinges adjusted horizontally
- three concealed hinges in a non-rebated leaf, silver (optionally black - subject to an additional charge); hinges supplied with and included in the price of the door frame
- deadbolt lock in a rebated door leaf and a key-locked magnetic lock in a non-rebated door leaf, thumb turn cylinder, economy, with a silver blockade; optionally, for an additional charge, a black, magnetic lock

GLAZING

- standard 4 mm clear or milk tempered glass and for an additional charge VSG 221 milk glass or black **NEW** safety glass, smooth on both sides
- possibility to change the glazing side to REVERSE (OBSERVE - standard glazing)

AVAILABLE SOLUTIONS (p. 135-143)

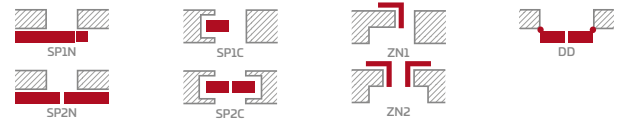

AVAILABLE DOOR LEAF WIDTHS

60 70 80 90 100

EXTRA CHARGES

free of charge factory drilled through holes for the handles (split handles) ordered in the package with the leaf **NEW**

ventilation cut

plastic woodgrain sleeves (4 pcs)

round or square metal sleeves (4 pcs); brushed nickel, patina, black or white

ventilation grille (only for door leaf widths of 80, 90, 100)

“100” rebated and non-rebated door leaf

frosted or black VSG 221 **NEW** laminated safety glass, smooth on both sides

metal hinge casings in the rebated door leaf (brushed nickel, patina, polished chrome, polished brass, white or black)

drop-down gasket ²⁾

can be replaced with a black magnetic lock for non-rebated door leaves

magnetic stop (buffer) ²⁾ **NEW**
(available in six colours p. 132)

GREKO

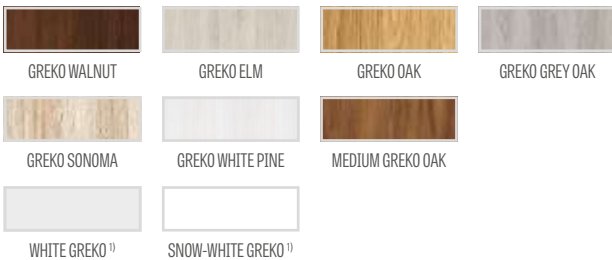

PREMIUM

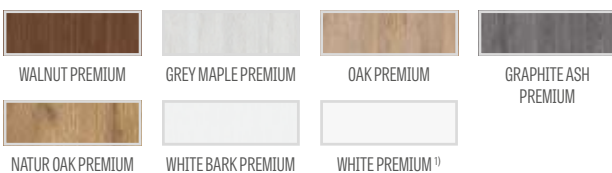

CPL

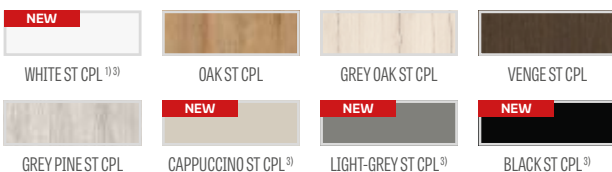

MDF stile for the GREKO and CPL laminates with the AntiFinger coating **NEW**



Glulam wood stile for the PREMIUM and CPL laminates without the AntiFinger coating

¹⁾ plain white laminate imitating a painted surface

²⁾ a stop prevents application of a drop-down gasket and vice versa

³⁾ special AntiFinger **NEW** coating to reduce dirt and fingerprints



ORCHIDEA

REBATED AND NON-REBATED INTERIOR STILE DOOR LEAVES



ORCHIDEA 4 WITH BLACK ST CPL laminate, with black mat CUBE handle



ORCHIDEA 1



ORCHIDEA 2



ORCHIDEA 3



ORCHIDEA 4



ORCHIDEA 5



ORCHIDEA 6

ORCHIDEA 4 with WHITE ST CPL laminate with glossy brass BELLA slim handle, gold



CONSTRUCTION

- rebated or non-rebated door leaf made in the STILE technology
- MDF board vertical stiles covered with the ST CPL and ST CPL laminate with the AntiFinger **NEW** coating and vertical glulam stiles covered with thin HDF panels and the PREMIUM or CPL laminate without the AntiFinger coating
- optionally, upon extra charge, upper panels extending the frame – page 134

HARDWARE

- rebated door leaves: three silver 2-pin hinges adjusted horizontally
- three concealed hinges in a non-rebated leaf, silver (optionally black - subject to an additional charge); hinges supplied with and included in the price of the door frame
- deadbolt lock in a rebated door leaf and a key-locked magnetic lock in a non-rebated door leaf, thumb turn cylinder, economy, with a silver blockade; optionally, for an additional charge, a black, magnetic lock

GLAZING

- standard VSG 221 frosted or clear laminated glass with application black or gold **NEW**

AVAILABLE SOLUTIONS (p. 135-143)

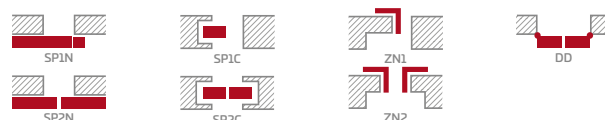

AVAILABLE DOOR LEAF WIDTHS



EXTRA CHARGES

free of charge factory drilled through holes for the handles (split handles) ordered in the package with the leaf **NEW**

ventilation cut

plastic woodgrain sleeves (4 pcs)

round or square metal sleeves (4 pcs); brushed nickel, patina, black or white

ventilation grille (only for door leaf widths of 80, 90, 100)

“100” rebated and non-rebated door leaf

metal hinge casings in rebated door leaf (colour: brushed nickel, patina, glossy chrome, glossy brass, white or black)

drop-down gasket ²⁾

can be replaced with a black magnetic lock for non-rebated door leaves

magnetic stop (buffer) ²⁾ **NEW**
(available in six colours p. 132)

PREMIUM

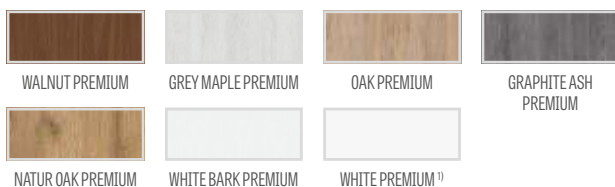

CPL

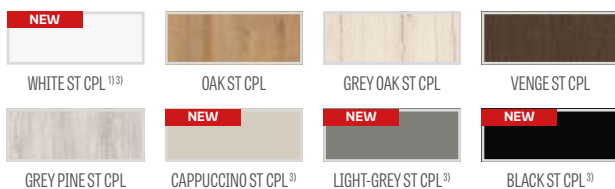

MDF stile for CPL laminates with the AntiFinger coating **NEW**



Glulam wood stile for the PREMIUM and CPL laminates without the AntiFinger coating

¹⁾ plain white laminate imitating a painted surface

²⁾ a stop prevents application of a drop-down gasket and vice versa

³⁾ special AntiFinger **NEW** coating to reduce dirt and fingerprints



BUDLEJA

REBATED AND NON-REBATED INTERIOR STILE DOOR LEAVES



OAK ST CPL Finish, TOPAZ INOX handle



BUDLEJA 1



BUDLEJA 2



BUDLEJA 3



BUDLEJA 4



BUDLEJA 5



BUDLEJA 6



BUDLEJA 7



BUDLEJA 8

BUDLEJA 1 in OAK ST CPL finish with TOPPAZ INOX handle



CONSTRUCTION

- rebated or non-rebated door leaf made in the STILE technology
- MDF board vertical stiles covered with the GREKO and CPL laminate with the AntiFinger **NEW** coating and vertical glulam stiles covered with thin HDF panels and the PREMIUM or CPL laminate without the AntiFinger coating
- very wide crossbar - 35 mm
- optionally, upon extra charge, upper panels extending the frame – page 134

HARDWARE

- rebated door leaves: three silver 2-pin hinges adjusted horizontally
- three concealed hinges in a non-rebated leaf, silver (optionally black - subject to an additional charge); hinges supplied with and included in the price of the door frame
- deadbolt lock in a rebated door leaf and a key-locked magnetic lock in a non-rebated door leaf, thumb turn cylinder, economy, with a silver blockade; optionally, for an additional charge, a black, magnetic lock

GLAZING

- standard 4 mm clear or milk tempered glass and for an additional charge VSG 221 milk glass or black safety glass, smooth on both sides
- possibility to change the glazing side to REVERSE (OBVERSE - standard glazing)

AVAILABLE SOLUTIONS (p. 135-143)

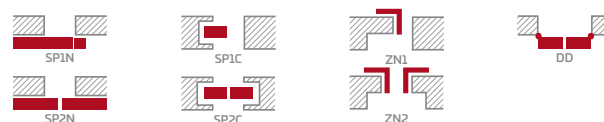

AVAILABLE DOOR LEAF WIDTHS

60 70 80 90 100

EXTRA CHARGES

free of charge factory drilled through holes for the handles (split handles) ordered in the package with the leaf **NEW**

ventilation cut

plastic woodgrain sleeves (4 pcs)

round or square metal sleeves (4 pcs); brushed nickel, patina, black or white

ventilation grille (only for door leaf widths of 80, 90, 100)

"100" rebated and non-rebated door leaf

frosted or black VSG 221 laminated safety glass, smooth on both sides

metal hinge casings in rebated door leaf (colour: brushed nickel, patina, glossy chrome, glossy brass, white or black)

drop-down gasket ²⁾

can be replaced with a black magnetic lock for non-rebated door leaves

magnetic stop (buffer) ²⁾ **NEW**
(available in six colours p. 132)

PREMIUM

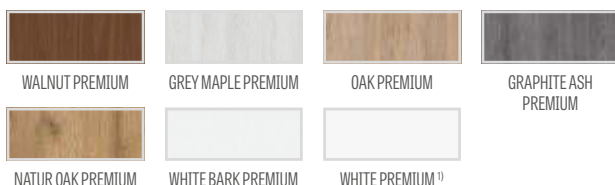

CPL

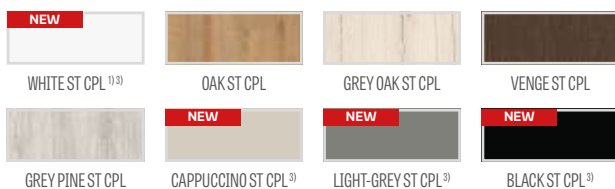

MDF stile for CPL laminates with the AntiFinger coating **NEW**

Glulam wood stile for the PREMIUM and CPL laminates without the AntiFinger coating

¹⁾ plain white laminate imitating a painted surface

²⁾ a stop prevents application of a drop-down gasket and vice versa

³⁾ special AntiFinger **NEW** coating to reduce dirt and fingerprints



EPIMEDIUM

REBATED AND NON-REBATED INTERIOR STILE DOOR LEAVES



EPIMEDIUM 4, decor: GRAFIT PREMIUM ASH, CUBE handle, brushed chrome, matt

WIDTH 80



EPIMEDIUM 1^{*)}



EPIMEDIUM 2^{*)}



EPIMEDIUM 3^{*)}



EPIMEDIUM 4^{*)}



EPIMEDIUM 5^{*)}

WIDTH 70



EPIMEDIUM 1^{*)}



EPIMEDIUM 2^{*)}



EPIMEDIUM 3^{*)}



EPIMEDIUM 4^{*)}



EPIMEDIUM 5^{*)}

^{*)} The pictures show only the EPIMEDIUM doors with 80 and 70 cm wide leaves.

The glazing to vertical bars ratio in the other width options differs considerably, which can be the key factor regarding the customer's product choice.

For the other width options go to www.erkado.pl

EPI MEDIUM 1 in GRAPHITE PREMIUM finish with matt brushed chrome CUBE handle



CONSTRUCTION

- rebated or non-rebated door leaf made in the STILE technology
- MDF board vertical stiles covered with the GREKO and CPL laminate with the AntiFinger **NEW** coating and vertical glulam stiles covered with thin HDF panels and the PREMIUM or CPL laminate without the AntiFinger coating
- 4mm thick HDF panels with GREKO, CPL or PREMIUM finish
- narrow, long crossbar of 22 mm
- optionally, upon extra charge, upper panels extending the frame – page 134

HARDWARE

- rebated door leaves: three silver 2-pin hinges adjusted horizontally
- three concealed hinges in a non-rebated leaf, silver (optionally black - subject to an additional charge); hinges supplied with and included in the price of the door frame
- deadbolt lock in a rebated door leaf and a key-locked magnetic lock in a non-rebated door leaf, thumb turn cylinder, economy, with a silver blockade; optionally, for an additional charge, a black, magnetic lock

GLAZING

- standard 4 mm clear or milk tempered glass and for an additional charge VSG 221 milk glass or black **NEW** safety glass, smooth on both sides
- possibility to change the glazing side to REVERSE (OBSERVE - standard glazing)
- depending on the leaf width, the glazing widths differ.
Check at www.erkado.pl

AVAILABLE SOLUTIONS (p. 135-143)

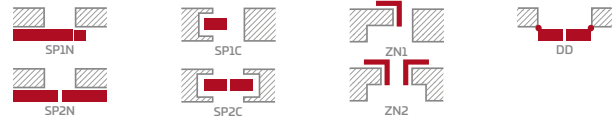

AVAILABLE DOOR LEAF WIDTHS



EXTRA CHARGES

free of charge factory drilled through holes for the handles (split handles) ordered in the package with the leaf **NEW**

ventilation cut

plastic woodgrain sleeves (4 pcs)

round or square metal sleeves (4 pcs); brushed nickel, patina, black or white

ventilation grille (only for door leaf widths of 80, 90, 100)

"100" rebated and non-rebated door leaf

frosted or black **NEW** VSG 221 laminated safety glass, smooth on both sides

metal hinge casings in the rebated door leaf (brushed nickel, patina, polished chrome, polished brass, white or black)

drop-down gasket ²⁾

can be replaced with a black magnetic lock for non-rebated door leaves

magnetic stop (buffer) ²⁾ **NEW**
(available in six colours p. 132)

GREKO

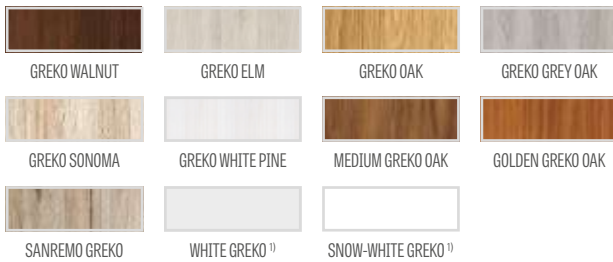

PREMIUM

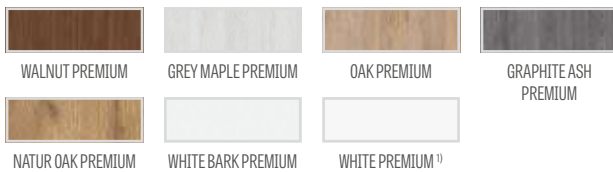

CPL

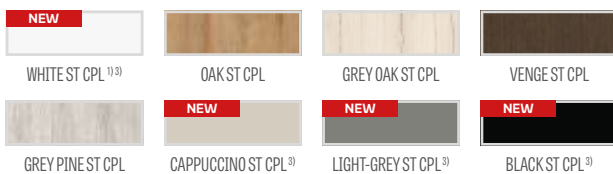

MDF stile for the GREKO and CPL laminates with the AntiFinger coating **NEW**
Glulam wood stile for the PREMIUM and CPL laminates without the AntiFinger coating

¹⁾ plain white laminate imitating a painted surface

²⁾ a stop prevents application of a drop-down gasket and vice versa

³⁾ special AntiFinger **NEW** coating to reduce dirt and fingerprints



ARALIA, NOLINA, EWODIA

REBATED AND NON-REBATED INTERIOR STILE DOOR LEAVES



ARALIA 1, decor WHITE PREMIUM BARK, handle RUMBA antibacterial, black



ARALIA 1



NOLINA 1



EWODIA 1



EWODIA 2



EWODIA 4

NOLINA 1 in GREY MAPLE PREMIUM finish with TOPAZ INOX handle



CONSTRUCTION

- rebated or non-rebated door leaf made in the STILE technology
- timber stiles covered with thin HDF boards and with PREMIUM surface
- 16 mm thick HDF panels with PREMIUM finish (vertical grain direction)
- optionally, upon extra charge, upper panels extending the frame – page 134

HARDWARE

- rebated door leaves: three silver 2-pin hinges adjusted horizontally
- three concealed hinges in a non-rebated leaf, silver (optionally black - subject to an additional charge); hinges supplied with and included in the price of the door frame
- deadbolt lock in a rebated door leaf and a key-locked magnetic lock in a non-rebated door leaf, thumb turn cylinder, economy, with a silver blockade; optionally, for an additional charge, a black, magnetic lock

GLAZING

- frosted decor mat glass 4 mm or custom-made frosted VSG 221 laminated safety glass, frosted or black **NEW** smooth on both sides, for an additional charge
- possibility to change the glazing side to REVERSE (OBVERSE - standard glazing)

AVAILABLE SOLUTIONS (p. 135-143)

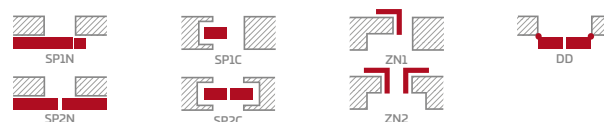

AVAILABLE DOOR LEAF WIDTHS

60 70 80 90 100

EXTRA CHARGES

free of charge factory drilled through holes for the handles (split handles) ordered in the package with the leaf **NEW**

ventilation cut

plastic woodgrain sleeves (4 pcs)

round or square metal sleeves (4 pcs); brushed nickel, patina, black or white

ventilation grille (only for door leaf widths of 80, 90, 100)

"100" rebated and non-rebated door leaf

frosted or black VSG 221 **NEW** laminated safety glass, smooth on both sides

metal hinge casings in rebated door leaf
(colour: brushed nickel, patina, glossy chrome, glossy brass, white or black)

drop-down gasket ¹⁾

can be replaced with a black magnetic lock for non-rebated door leaves

magnetic stop (buffer) ¹⁾ **NEW**
(available in six colours p. 132)

PREMIUM

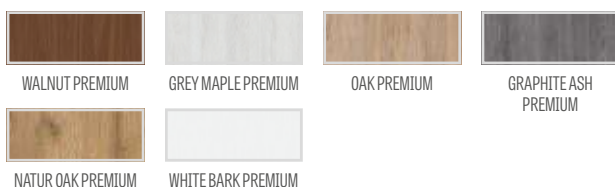

Glulam timber stile for PREMIUM laminates

¹⁾ a stop prevents application of a drop-down gasket and vice versa



POWOJNIK

REBATED AND NON-REBATED INTERIOR STILE DOOR LEAVES



POWOJNIK 5, decor: GREY OAK ST CPL, TOPAZ INOX handle



POWOJNIK 1



POWOJNIK 2



POWOJNIK 3



POWOJNIK 4



POWOJNIK 5

POWOJNIK 1, GREY OAK ST CPL laminate with a TOPAZ INOX handle



CONSTRUCTION

- rebated or non-rebated door leaf made in the STILE technology
- MDF board vertical stiles covered with the CPL laminate with the AntiFinger **NEW** coating and vertical glulam stiles covered with thin HDF panels and the PREMIUM or CPL laminate without the AntiFinger coating
- 4mm thick HDF panels with CPL or PREMIUM laminate
- central crossbars of 22 mm in thickness and a very wide upper and bottom crossbar of 35 mm
- optionally, upon extra charge, upper panels extending the frame – page 134

HARDWARE

- rebated door leaves: three silver 2-pin hinges adjusted horizontally
- three concealed hinges in a non-rebated leaf, silver (optionally black - subject to an additional charge); hinges supplied with and included in the price of the door frame
- deadbolt lock in a rebated door leaf and a key-locked magnetic lock in a non-rebated door leaf, thumb turn cylinder, economy, with a silver blockade; optionally, for an additional charge, a black, magnetic lock

GLAZING

- standard 4 mm clear or milk tempered glass and for an additional charge VSG 221 milk glass or black **NEW** safety glass, smooth on both sides
- possibility to change the glazing side to REVERSE (OBSERVE - standard glazing)

AVAILABLE SOLUTIONS (p. 135-143)

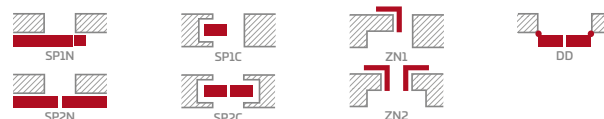

AVAILABLE DOOR LEAF WIDTHS

60 70 80 90 100

EXTRA CHARGES

free of charge factory drilled through holes for the handles (split handles) ordered in the package with the leaf **NEW**

ventilation cut

plastic woodgrain sleeves (4 pcs)

round or square metal sleeves (4 pcs); brushed nickel, patina, black or white

ventilation grille (only for door leaf widths of 80, 90, 100)

"100" rebated and non-rebated door leaf

frosted or black **NEW** VSG 221 laminated safety glass, smooth on both sides

metal hinge casings in rebated door leaf (colour: brushed nickel, patina, glossy chrome, glossy brass, white or black)

drop-down gasket ²⁾

can be replaced with a black magnetic lock for non-rebated door leaves

magnetic stop (buffer) ²⁾ **NEW**
(available in six colours p. 132)

PREMIUM

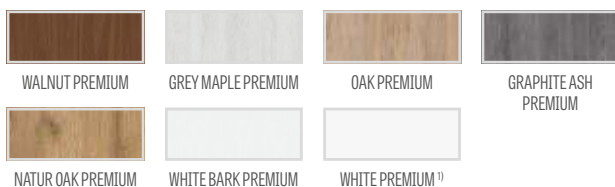

CPL

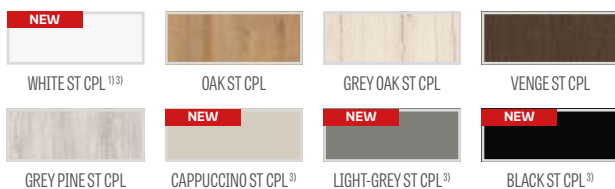

MDF stile for CPL laminates with the AntiFinger **NEW**

Glulam wood stile for the PREMIUM and CPL laminates without the AntiFinger coating

¹⁾ plain white laminate imitating a painted surface

²⁾ a stop prevents application of a drop-down gasket and vice versa

³⁾ special AntiFinger **NEW** coating to reduce dirt and fingerprints



MAGNOLIA

REBATED AND NON-REBATED INTERIOR STILE DOOR LEAVES



MAGNOLIA 1, decor: GREKO NUT; DECO handle



MAGNOLIA 1



MAGNOLIA 2



MAGNOLIA 3



MAGNOLIA 4



MAGNOLIA 5



MAGNOLIA 6



MAGNOLIA 7



MAGNOLIA 8

MAGNOLIA 1 with WALNUT GREKO laminate and DECO handle



CONSTRUCTION

- rebated or non-rebated door leaf made in the STILE technology
- MDF board vertical stiles covered with the GREKO and CPL laminate with the AntiFinger coating and **NEW** vertical glulam stiles covered with thin HDF panels and the PREMIUM or CPL laminate without the AntiFinger coating
- 4mm thick HDF panels with GREKO, CPL or PREMIUM finish
- optionally, upon extra charge, upper panels extending the frame – page 134

HARDWARE

- rebated door leaves: three silver 2-pin hinges adjusted horizontally
- three concealed hinges in a non-rebated leaf, silver (optionally black - subject to an additional charge); hinges supplied with and included in the price of the door frame
- deadbolt lock in a rebated door leaf and a key-locked magnetic lock in a non-rebated door leaf, thumb turn cylinder, economy, with a silver blockade; optionally, for an additional charge, a black, magnetic lock

GLAZING

- standard 4 mm clear or milk tempered glass and for an additional charge VSG 221 milk glass or black safety glass, smooth on both sides
- possibility to change the glazing side to REVERSE (OBSERVE - standard glazing)

AVAILABLE SOLUTIONS (p. 135-143)

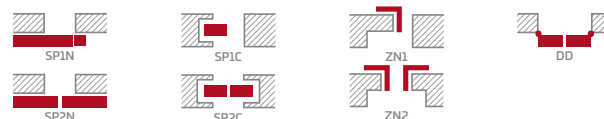

AVAILABLE DOOR LEAF WIDTHS

60 70 80 90 100

EXTRA CHARGES

free of charge factory drilled through holes for the handles (split handles) ordered in the package with the leaf **NEW**

ventilation cut

plastic woodgrain sleeves (4 pcs)

round or square metal sleeves (4 pcs); brushed nickel, patina, black or white

ventilation grille (only for door leaf widths of 80, 90, 100)

"100" rebated and non-rebated door leaf

frosted or black VSG 221 laminated safety glass, smooth on both sides

metal hinge casings in rebated door leaf (colour: brushed nickel, patina, glossy chrome, glossy brass, white or black)

drop-down gasket ²⁾

can be replaced with a black magnetic lock for non-rebated door leaves

magnetic stop (buffer) ²⁾ **NEW**
(available in six colours p. 132)

GREKO

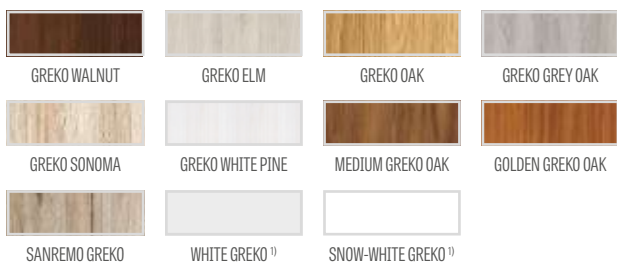

PREMIUM

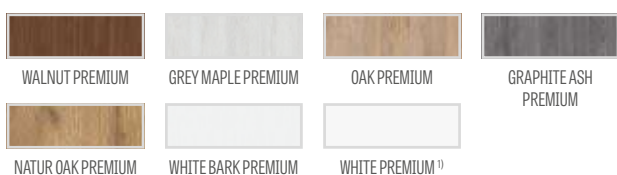

CPL

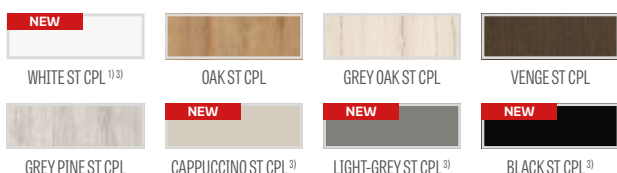

MDF stile for the GREKO and CPL laminates with the AntiFinger coating **NEW** Glulam wood stile for the PREMIUM and CPL laminates without the AntiFinger coating

¹⁾ plain white laminate imitating a painted surface

²⁾ a stop prevents application of a drop-down gasket and vice versa

³⁾ special AntiFinger **NEW** coating to reduce dirt and fingerprints



JUKA

REBATED AND NON-REBATED INTERIOR STILE DOOR LEAVES



JUKA 4, decor: MEDIUM GREKO OAK, TOPAZ INOX handle



JUKA 1



JUKA 2



JUKA 3



JUKA 4



JUKA 5



JUKA 6



JUKA 7



JUKA 8

JUKA1 with MEDIUM GREKO OAK laminate and a TOPAZ INOX handle



CONSTRUCTION

- rebated or non-rebated door leaf made in the STILE technology
- MDF board vertical stiles covered with the GREKO and CPL laminate with the AntiFinger coating and **NEW** vertical glulam stiles covered with thin HDF panels and the PREMIUM or CPL laminate without the AntiFinger coating
- 4mm thick HDF panels with GREKO, CPL or PREMIUM finish
- optionally, upon extra charge, upper panels extending the frame – page 134

HARDWARE

- rebated door leaves: three silver 2-pin hinges adjusted horizontally
- three concealed hinges in a non-rebated leaf, silver (optionally black - subject to an additional charge); hinges supplied with and included in the price of the door frame
- deadbolt lock in a rebated door leaf and a key-locked magnetic lock in a non-rebated door leaf, thumb turn cylinder, economy, with a silver blockade; optionally, for an additional charge, a black, magnetic lock

GLAZING

- standard 4 mm clear or milk tempered glass and for an additional charge VSG 221 milk glass or black safety glass, smooth on both sides
- possibility to change the glazing side to REVERSE (OBVERSE - standard glazing)

AVAILABLE SOLUTIONS (p. 135-143)

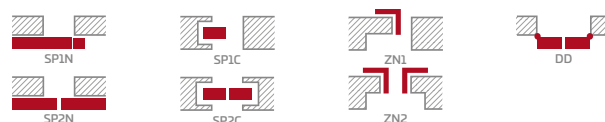

AVAILABLE DOOR LEAF WIDTHS



GREKO

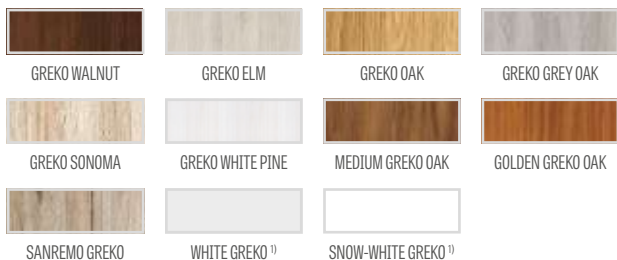

PREMIUM

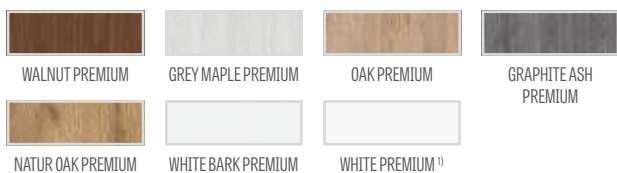

CPL

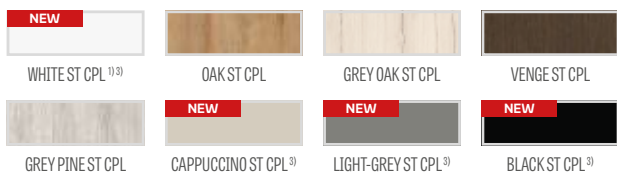

EXTRA CHARGES

free of charge factory drilled through holes for the handles (split handles) ordered in the package with the leaf **NEW**

ventilation cut

plastic woodgrain sleeves (4 pcs)

round or square metal sleeves (4 pcs); brushed nickel, patina, black or white

ventilation grille (only for door leaf widths of 80, 90, 100)

"100" rebated and non-rebated door leaf

frosted or black VSG 221 laminated safety glass, smooth on both sides

metal hinge casings in the rebated door leaf (brushed nickel, patina, polished chrome, polished brass, white or black)

drop-down gasket 2)

can be replaced with a black magnetic lock for non-rebated door leaves

magnetic stop (buffer) 2) **NEW**
(available in six colours p. 132)

MDF stile for the GREKO and CPL laminates with the AntiFinger coating **NEW** Glulam wood stile for the PREMIUM and CPL laminates without the AntiFinger coating

1) plain white laminate imitating a painted surface

2) a stop prevents application of a drop-down gasket and vice versa

3) special **AntiFinger** **NEW** coating to reduce dirt and fingerprints



FORSYCJA

REBATED AND NON-REBATED INTERIOR STILE DOOR LEAVES



FORSYCJA 1, door-leaf decor: WHITE GREKO, door-frame decor: OAK PREMIUM, handle: BELLA slim, black matt



FORSYCJA 1



FORSYCJA 2



FORSYCJA 3



FORSYCJA 4



FORSYCJA 5



FORSYCJA 6



FORSYCJA 7



FORSYCJA 8

FORSYCJA 4 with WHITE GREKO laminate and a black matt CUBE handle



CONSTRUCTION

- rebated or non-rebated door leaf made in the STILE technology
- MDF board vertical stiles covered with the GREKO and CPL laminate with the AntiFinger coating and **NEW** vertical glulam stiles covered with thin HDF panels and the PREMIUM or CPL laminate without the AntiFinger coating
- 4mm thick HDF panels with GREKO, CPL or PREMIUM finish
- optionally, upon extra charge, upper panels extending the frame – page 134

HARDWARE

- rebated door leaves: three silver 2-pin hinges adjusted horizontally
- three concealed hinges in a non-rebated leaf, silver (optionally black - subject to an additional charge); hinges supplied with and included in the price of the door frame
- deadbolt lock in a rebated door leaf and a key-locked magnetic lock in a non-rebated door leaf, thumb turn cylinder, economy, with a silver blockade; optionally, for an additional charge, a black, magnetic lock

GLAZING

- standard 4 mm clear or milk tempered glass and for an additional charge VSG 221 milk glass or black safety glass, smooth on both sides
- possibility to change the glazing side to REVERSE (OBVERSE - standard glazing)

AVAILABLE SOLUTIONS (p. 135-143)

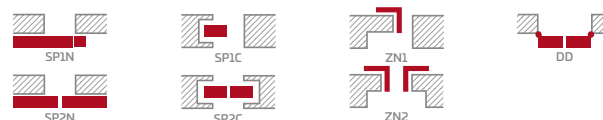

AVAILABLE DOOR LEAF WIDTHS



EXTRA CHARGES

free of charge factory drilled through holes for the handles (split handles) ordered in the package with the leaf **NEW**

ventilation cut

plastic woodgrain sleeves (4 pcs)

round or square metal sleeves (4 pcs); brushed nickel, patina, black or white

ventilation grille (only for door leaf widths of 80, 90, 100)

"100" rebated and non-rebated door leaf

frosted or black VSG 221 laminated safety glass, smooth on both sides

metal hinge casings in the rebated door leaf (brushed nickel, patina, polished chrome, polished brass, white or black)

drop-down gasket ²⁾

can be replaced with a black magnetic lock for non-rebated door leaves

magnetic stop (buffer) ²⁾ **NEW**
(available in six colours p. 132)

GREKO

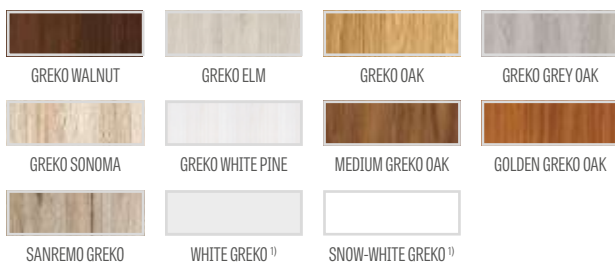

PREMIUM

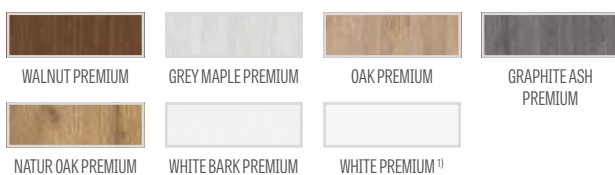

CPL

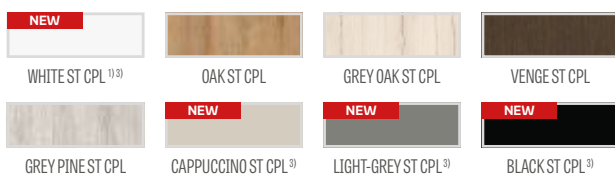

MDF stile for the GREKO and CPL laminates with the AntiFinger coating **NEW** Glulam wood stile for the PREMIUM and CPL laminates without the AntiFinger coating

¹⁾ plain white laminate imitating a painted surface

²⁾ a stop prevents application of a drop-down gasket and vice versa

³⁾ special **AntiFinger** **NEW** coating to reduce dirt and fingerprints



LAWENDA

REBATED AND NON-REBATED INTERIOR STILE DOOR LEAVES



LAWENDA 7, decor: GREKO OAK, DECO handle



LAWENDA 1



LAWENDA 2



LAWENDA 3



LAWENDA 4



LAWENDA 5



LAWENDA 6



LAWENDA 7



LAWENDA 8



LAWENDA 9

LAWENDA 1 with GREKO OAK laminate and a DECO handle



CONSTRUCTION

- rebated or non-rebated door leaf made in the STILE technology
- MDF board vertical stiles covered with the GREKO and CPL laminate with the AntiFinger coating and **NEW** vertical glulam stiles covered with thin HDF panels and the PREMIUM or CPL laminate without the AntiFinger coating
- 4mm thick HDF panels with GREKO, CPL or PREMIUM finish
- optionally, upon extra charge, upper panels extending the frame – page 134

HARDWARE

- rebated door leaves: three silver 2-pin hinges adjusted horizontally
- three concealed hinges in a non-rebated leaf, silver (optionally black - subject to an additional charge); hinges supplied with and included in the price of the door frame
- deadbolt lock in a rebated door leaf and a key-locked magnetic lock in a non-rebated door leaf, thumb turn cylinder, economy, with a silver blockade; optionally, for an additional charge, a black, magnetic lock

GLAZING

- standard 4 mm clear or milk tempered glass and for an additional charge VSG 221 milk glass or black safety glass, smooth on both sides
- possibility to change the glazing side to REVERSE (OBVERSE - standard glazing)

AVAILABLE SOLUTIONS (p. 135-143)

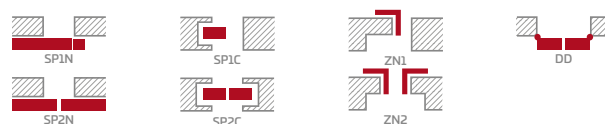

AVAILABLE DOOR LEAF WIDTHS



EXTRA CHARGES

free of charge factory drilled through holes for the handles (split handles) ordered in the package with the leaf **NEW**

ventilation cut

plastic woodgrain sleeves (4 pcs)

round or square metal sleeves (4 pcs); brushed nickel, patina, black or white

ventilation grille (only for door leaf widths of 80, 90, 100)

"100" rebated and non-rebated door leaf

frosted or black VSG 221 laminated safety glass, smooth on both sides

metal hinge casings in the rebated door leaf (brushed nickel, patina, polished chrome, polished brass, white or black)

drop-down gasket ²⁾

can be replaced with a black magnetic lock for non-rebated door leaves

magnetic stop (buffer) ²⁾ **NEW**
(available in six colours p. 132)

GREKO

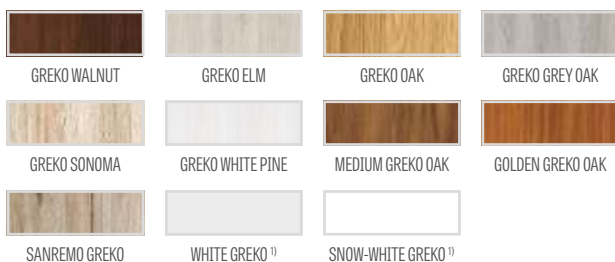

PREMIUM

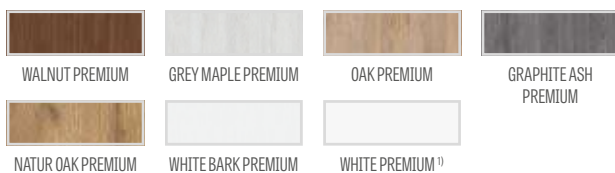

CPL

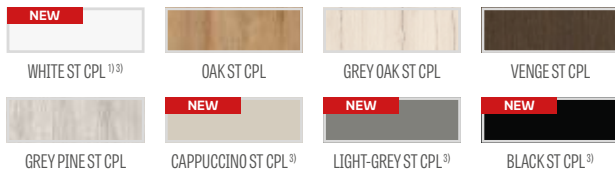

MDF stile for the GREKO and CPL laminates with the AntiFinger coating **NEW** Glulam wood stile for the PREMIUM and CPL laminates without the AntiFinger coating

¹⁾ plain white laminate imitating a painted surface

²⁾ a stop prevents application of a drop-down gasket and vice versa

³⁾ special **AntiFinger** **NEW** coating to reduce dirt and fingerprints



IRYS

REBATED AND NON-REBATED INTERIOR STILE DOOR LEAVES



WHITE PREMIUM Finish, black CUBE handle



IRYS 1



IRYS 2



IRYS 3



IRYS 4



IRYS 5



IRYS 6



IRYS 7



IRYS 8

IRYS 1 in WHITE PREMIUM laminate with a black CUBE handle



GREKO

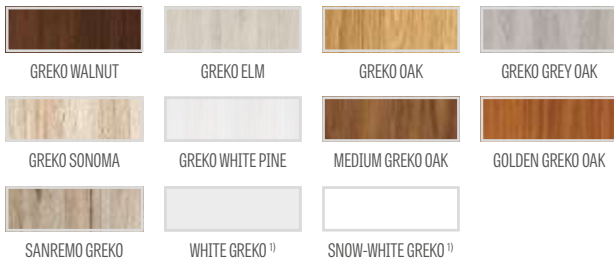

PREMIUM

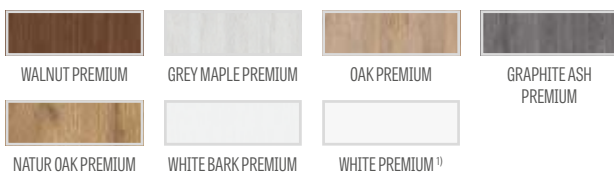

CPL

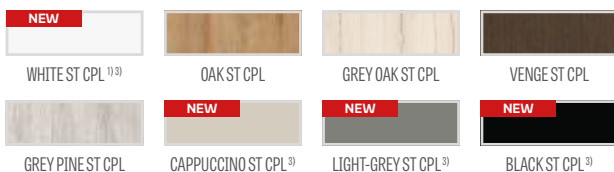

MDF stile for the GREKO and CPL laminates with the AntiFinger coating **NEW** Glulam wood stile for the PREMIUM and CPL laminates without the AntiFinger coating

CONSTRUCTION

- rebated or non-rebated door leaf made in the STILE technology
- MDF board vertical stiles covered with the GREKO and CPL laminate with the AntiFinger coating and **NEW** vertical glulam stiles covered with thin HDF panels and the PREMIUM or CPL laminate without the AntiFinger coating
- 4mm thick HDF panels with GREKO, CPL or PREMIUM finish
- optionally, upon extra charge, upper panels extending the frame – page 134

HARDWARE

- rebated door leaves: three silver 2-pin hinges adjusted horizontally
- three concealed hinges in a non-rebated leaf, silver (optionally black - subject to an additional charge); hinges supplied with and included in the price of the door frame
- deadbolt lock in a rebated door leaf and a key-locked magnetic lock in a non-rebated door leaf, thumb turn cylinder, economy, with a silver blockade; optionally, for an additional charge, a black, magnetic lock

GLAZING

- tempered 4 mm glass, frosted or transparent as a standard and, for an additional charge, laminated VSG 221 safety glass frosted or black **NEW** smooth on both sides
- possibility to change the glazing side to REVERSE (OBSERVE - standard glazing)

AVAILABLE SOLUTIONS (p. 135-143)

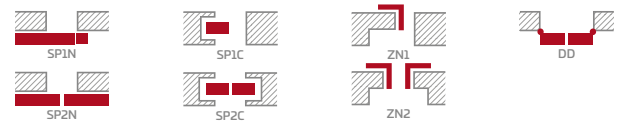

AVAILABLE DOOR LEAF WIDTHS



EXTRA CHARGES

free of charge factory drilled through holes for the handles (split handles) ordered in the package with the leaf **NEW**

ventilation cut

plastic woodgrain sleeves (4 pcs)

round or square metal sleeves (4 pcs); brushed nickel, patina, black or white

ventilation grille (only for door leaf widths of 80, 90, 100)

"100" rebated and non-rebated door leaf

frosted or black VSG 221 laminated safety glass **NEW**, smooth on both sides

metal hinge casings in rebated door leaf (colour: brushed nickel, patina, glossy chrome, glossy brass, white or black)

drop-down gasket 2)

can be replaced with a black magnetic lock for non-rebated door leaves

magnetic stop (buffer) 2) **NEW** (available in six colours p. 132)

1) plain white laminate imitating a painted surface

2) a stop prevents application of a drop-down gasket and vice versa

3) special AntiFinger **NEW** coating to reduce dirt and fingerprints



DAGLEZJA

REBATED AND NON-REBATED INTERIOR STILE DOOR LEAVES



DAGLEZJA 1, decor: GREKO GREY OAK, CUBE SLIM handle, square, black matt



DAGLEZJA 1



DAGLEZJA 2



DAGLEZJA 3



DAGLEZJA 4



DAGLEZJA 5



DAGLEZJA 6



DAGLEZJA 7



DAGLEZJA 8

DAGLEZJA 6 with GREKO GREY OAK laminate and a black matt chrome CUBE SLIM handle



GREKO

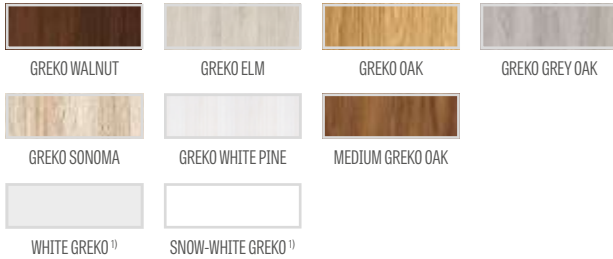

PREMIUM

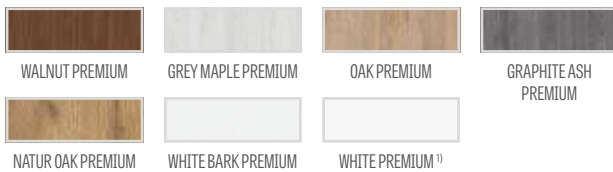

CPL

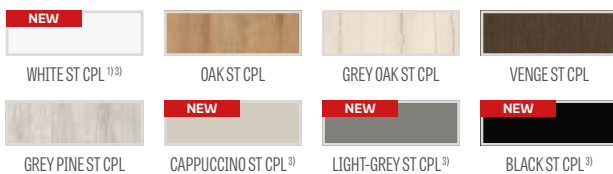

MDF stile for the GREKO and CPL laminates with the AntiFinger coating **NEW** Glulam wood stile for the PREMIUM and CPL laminates without the AntiFinger coating

CONSTRUCTION

- rebeded or non-rebeded door leaf made in the STILE technology
- MDF board vertical stiles covered with the GREKO and CPL laminate with the AntiFinger coating and **NEW** vertical glulam stiles covered with thin HDF panels and the PREMIUM or CPL laminate without the AntiFinger coating
- 4mm thick HDF panels with GREKO, CPL or PREMIUM finish
- very wide crossbar
- optionally, upon extra charge, upper panels extending the frame – page 134

HARDWARE

- rebeded door leaves: three silver 2-pin hinges adjusted horizontally
- three concealed hinges in a non-rebeded leaf, silver (optionally black - subject to an additional charge); hinges supplied with and included in the price of the door frame
- deadbolt lock in a rebeded door leaf and a key-locked magnetic lock in a non-rebeded door leaf, thumb turn cylinder, economy, with a silver blockade; optionally, for an additional charge, a black, magnetic lock

GLAZING

- standard 4 mm clear or milk tempered glass and for an additional charge VSG 221 milk glass or black safety glass, smooth on both sides
- possibility to change the glazing side to REVERSE (OBSERVE - standard glazing)

AVAILABLE SOLUTIONS (p. 135-143)

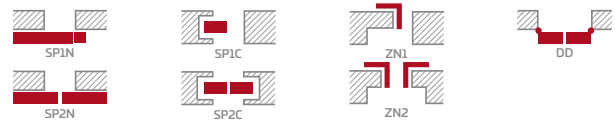

AVAILABLE DOOR LEAF WIDTHS



EXTRA CHARGES

free of charge factory drilled through holes for the handles (split handles) ordered in the package with the leaf **NEW**

ventilation cut

plastic woodgrain sleeves (4 pcs)

round or square metal sleeves (4 pcs); brushed nickel, patina, black or white

ventilation grille (only for door leaf widths of 80, 90, 100)

"100" rebated and non-rebeded door leaf

frosted or black VSG 221 laminated safety glass, smooth on both sides

metal hinge casings in rebated door leaf (colour: brushed nickel, patina, glossy chrome, glossy brass, white or black)

drop-down gasket ²⁾

can be replaced with a black magnetic lock for non-rebeded door leaves

magnetic stop (buffer) ²⁾ **NEW**
(available in six colours p. 132)

¹⁾ plain white laminate imitating a painted surface

²⁾ a stop prevents application of a drop-down gasket and vice versa

³⁾ special **AntiFinger** **NEW** coating to reduce dirt and fingerprints



FREZJA

REBATED AND NON-REBATED INTERIOR STILE DOOR LEAVES



FREZJA 5, decor: PINE ST CPL, black matt CUBE SLIM handle



FREZJA 1



FREZJA 2



FREZJA 3



FREZJA 4



FREZJA 2



FREZJA 4



FREZJA 6



FREZJA 5



FREZJA 6



FREZJA 7³⁾



FREZJA 8²⁾



FREZJA 8
ventilation cut

²⁾ FREZJA 8 – 8 mm thick glazing
³⁾ FRESSIS 7 – with a mirror only and a selected finish on the other side. Obverse – a mirror fitted on the hinge side (as shown in the photo)

FREZJA 1 with GREY PINE ST CPL laminate and a black matt CUBE SLIM handle



CONSTRUCTION

- rebated or non-rebated door leaf made in the STILE technology
- MDF board vertical stiles covered with the GREKO and CPL laminate with the AntiFinger coating and **NEW** vertical glulam stiles covered with thin HDF panels and the PREMIUM or CPL laminate without the AntiFinger coating
- 16 mm thick HDF panels (also a 4 mm panel for the FREZJA 2 & 6 models) covered with the GREKO, CPL or PREMIUM laminate; FREZJA 7 is available with a mirror only
- optionally, upon extra charge, upper panels extending the frame – page 134

HARDWARE

- rebated door leaves: three silver 2-pin hinges adjusted horizontally
- three concealed hinges in a non-rebated leaf, silver (optionally black - subject to an additional charge); hinges supplied with and included in the price of the door frame
- deadbolt lock in a rebated door leaf and a key-locked magnetic lock in a non-rebated door leaf, thumb turn cylinder, economy, with a silver blockade; optionally, for an additional charge, a black, magnetic lock

GLAZING

- 4 mm frosted or transparent tempered glass or a mirror fitted on one side (only FREZJA 7) as a standard and a VSG 221 frosted or black safety glass, smooth on both sides (does not apply to FREZJA 7, 8)
- possibility to change the glazing side to REVERSE (OBSERVE - standard glazing)
- fixed glazing widths: FREZJA 1 – 140 mm, FREESIAO 5 – 70 mm

GREKO

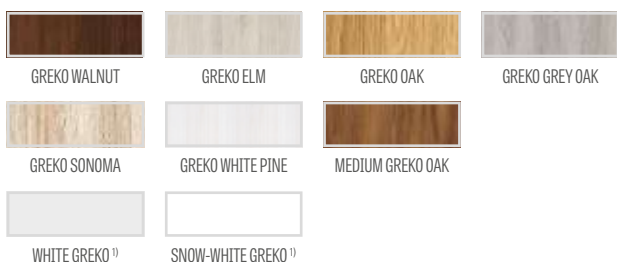

PREMIUM

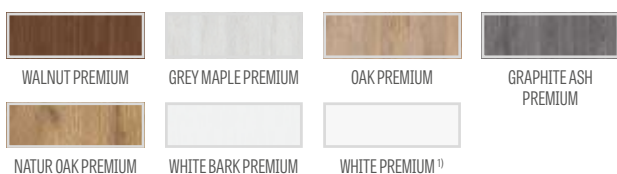

CPL

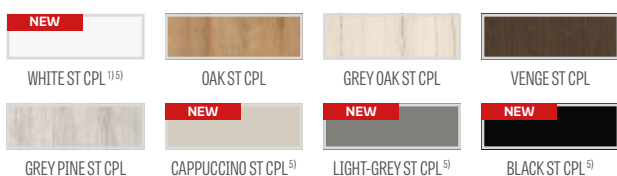

MDF stile for the GREKO and CPL laminates with the AntiFinger **NEW** coating
Glulam wood stile for the PREMIUM and CPL laminates without the AntiFinger coating

AVAILABLE SOLUTIONS ³⁾ (p. 135-143)

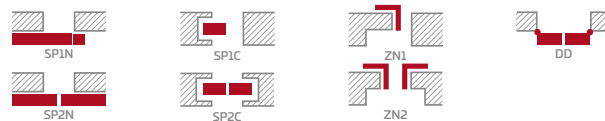

AVAILABLE DOOR LEAF WIDTHS



EXTRA CHARGES

free of charge factory drilled through holes for the handles (split handles) ordered in the package with the leaf **NEW**

ventilation cut

plastic woodgrain sleeves (4 pcs) ²⁾

round and square metal sleeves ²⁾ (4 pcs); brushed nickel or patina finish white and black

ventilation grille ²⁾ (only for door leaf widths of: 80, 90, 100)

"100" rebated and non-rebated door leaf

frosted or black VSG 221 laminated safety glass, smooth on both sides

metal hinge casings in the rebated door leaf (brushed nickel, patina, polished chrome, polished brass, white or black)

drop-down gasket gasket ⁴⁾ (not for FREZJA 8)

can be replaced with a black magnetic lock for non-rebated door leaves

magnetic stop (buffer) ⁴⁾ **NEW**
(available in six colours p. 132)

¹⁾ plain white laminate imitating a painted surface

²⁾ not available in FREZJA 8

³⁾ FREZJA 8 is not available for sliding systems

⁴⁾ a stop prevents application of a drop-down gasket and vice versa

⁵⁾ special AntiFinger **NEW** coating to reduce dirt and fingerprints



DEBECJA

REBATED AND NON-REBATED INTERIOR STILE DOOR LEAVES



DEBECJA 1, decor CAPPUCCINO ST CPL, handle BELLA brass glossy



DEBECJA 1



DEBECJA 2



DEBECJA 3



DEBECJA 4



DEBECJA 5



DEBECJA 6



DEBECJA 7

DEBECJA 7 with GRAPHITE ASH PREMIUM laminate and a glossy brass BELLA handle



CONSTRUCTION

- rebated or non-rebated door leaf made in the STILE technology
- MDF board vertical stiles covered with the GREKO and CPL laminate with the AntiFinger coating and **NEW** vertical glulam stiles covered with thin HDF panels and the PREMIUM or CPL laminate without the AntiFinger coating
- 4mm thick HDF panels with GREKO, CPL or PREMIUM finish
- very wide crossbar
- optionally, upon extra charge, upper panels extending the frame – page 134

HARDWARE

- rebated door leaves: three silver 2-pin hinges adjusted horizontally
- three concealed hinges in a non-rebated leaf, silver (optionally black - subject to an additional charge); hinges supplied with and included in the price of the door frame
- deadbolt lock in a rebated door leaf and a key-locked magnetic lock in a non-rebated door leaf, thumb turn cylinder, economy, with a silver blockade; optionally, for an additional charge, a black, magnetic lock

GLAZING

- standard 4 mm clear or milk tempered glass and for an additional charge VSG 221 milk glass or black **NEW** safety glass, smooth on both sides
- possibility to change the glazing side to REVERSE (OBSERVE - standard glazing)

AVAILABLE SOLUTIONS (p. 135-143)

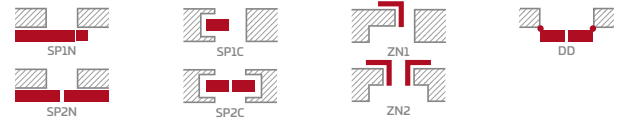

AVAILABLE DOOR LEAF WIDTHS

60 70 80 90 100

EXTRA CHARGES

free of charge factory drilled through holes for the handles (split handles) ordered in the package with the leaf **NEW**

ventilation cut

plastic woodgrain sleeves (4 pcs)

round or square metal sleeves (4 pcs); brushed nickel, patina, black or white

ventilation grille (only for door leaf widths of 80, 90, 100)

"100" rebated and non-rebated door leaf

frosted or black VSG 221 laminated safety glass **NEW**, smooth on both sides

metal hinge casings in rebated door leaf (colour: brushed nickel, patina, glossy chrome, glossy brass, white or black)

drop-down gasket ²⁾

can be replaced with a black magnetic lock for non-rebated door leaves

magnetic stop (buffer) ²⁾ **NEW**
(available in six colours p. 132)

GREKO

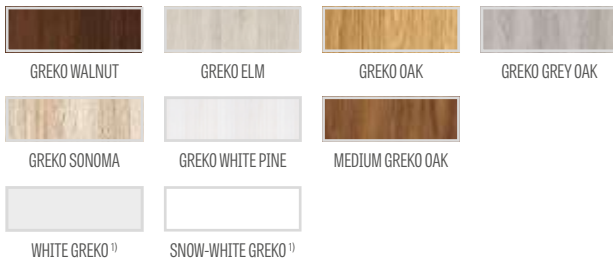

PREMIUM

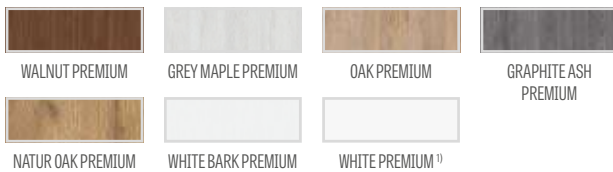

CPL

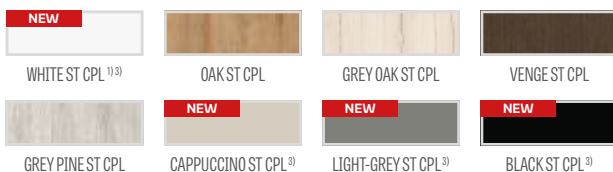

MDF stile for the GREKO and CPL laminates with the AntiFinger coating **NEW** Glulam wood stile for the PREMIUM and CPL laminates without the AntiFinger coating

¹⁾ plain white laminate imitating a painted surface

²⁾ a stop prevents application of a drop-down gasket and vice versa

³⁾ special **AntiFinger** **NEW** coating to reduce dirt and fingerprints



SURMIA

REBATED AND NON-REBATED INTERIOR STILE DOOR LEAVES



SURMIA 1, decor: VENGE ST CPL, brushed chrome, matt CUBE handle



SURMIA 1



SURMIA 2



SURMIA 3



SURMIA 4

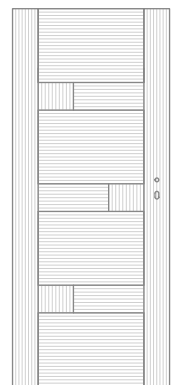

GRAIN PATTERN *)

SURMIA 4 with VENGE ST CPL laminate with matt brushed chrome CUBE handle



CONSTRUCTION

- rebated or non-rebated door leaf made in the STILE technology
- MDF board vertical stiles covered with the CPL laminate with the AntiFinger coating and **NEW** vertical glulam stiles covered with thin HDF panels and the PREMIUM or CPL laminate without the AntiFinger coating
- 22 mm and 4 mm thick HDF panels with CPL or PREMIUM finish
- very wide 35 mm thick crossbar
- optionally, upon extra charge, upper panels extending the frame – page 134

HARDWARE

- rebated door leaves: three silver 2-pin hinges adjusted horizontally
- three concealed hinges in a non-rebated leaf, silver (optionally black - subject to an additional charge); hinges supplied with and included in the price of the door frame
- deadbolt lock in a rebated door leaf and a key-locked magnetic lock in a non-rebated door leaf, thumb turn cylinder, economy, with a silver blockade; optionally, for an additional charge, a black, magnetic lock

GLAZING

- standard 4 mm clear or milk tempered glass and for an additional charge VSG 221 milk glass or black **NEW** safety glass, smooth on both sides
- possibility to change the glazing side to REVERSE (OBSERVE - standard glazing)

AVAILABLE SOLUTIONS (p. 135-143)

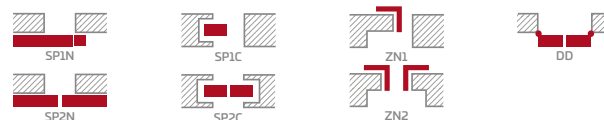

AVAILABLE DOOR LEAF WIDTHS

60 70 80 90 100

EXTRA CHARGES

free of charge factory drilled through holes for the handles (split handles) ordered in the package with the leaf **NEW**

ventilation cut

plastic woodgrain sleeves (4 pcs)

round or square metal sleeves (4 pcs); brushed nickel, patina, black or white

ventilation grille (only for door leaf widths of 80, 90, 100)

"100" rebated and non-rebated door leaf

frosted or black VSG 221 laminated safety glass **NEW**, smooth on both sides

metal hinge casings in rebated door leaf (colour: brushed nickel, patina, glossy chrome, glossy brass, white or black)

drop-down gasket ²⁾

can be replaced with a black magnetic lock for non-rebated door leaves

magnetic stop (buffer) ²⁾ **NEW** (available in six colours p. 132)

PREMIUM

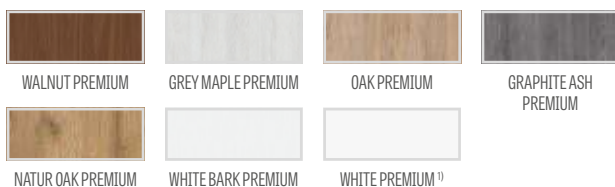

CPL

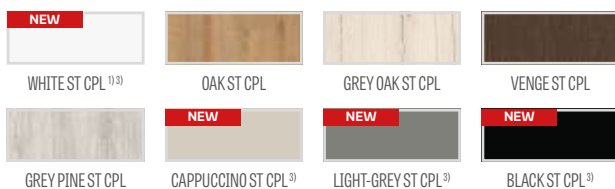

MDF stile for CPL laminates with the AntiFinger coating **NEW**

Glulam wood stile for the PREMIUM and CPL laminates without the AntiFinger coating

¹⁾ plain white laminate imitating a painted surface

²⁾ a stop prevents application of a drop-down gasket and vice versa

³⁾ special AntiFinger **NEW** coating to reduce dirt and fingerprints



BERBERYS

REBATED AND NON-REBATED INTERIOR STILE DOOR LEAVES



GRAPHITE ASH PREMIUM Finish, TOPAZ INOX handle



BERBERYS 1



BERBERYS 2



BERBERYS 3



BERBERYS 4



BERBERYS 5



BERBERYS 6



BERBERYS 7



BERBERYS 8

BERBERYS 1 with GRAPHITTE ASH PREMIUM laminate and a TOPPAZ INOX handle



CONSTRUCTION

- rebated or non-rebated door leaf made in the STILE technology
- MDF board vertical stiles covered with the GREKO and CPL laminate with the AntiFinger **NEW** coating and vertical glulam stiles covered with thin HDF panels and the PREMIUM or CPL laminate without the AntiFinger coating
- 4mm thick HDF panels with GREKO, CPL or PREMIUM finish
- brushed aluminium insert profiles
- optionally, upon extra charge, upper panels extending the frame – page 134

HARDWARE

- rebated door leaves: three silver 2-pin hinges adjusted horizontally
- three concealed hinges in a non-rebated leaf, silver (optionally black - subject to an additional charge); hinges supplied with and included in the price of the door frame
- deadbolt lock in a rebated door leaf and a key-locked magnetic lock in a non-rebated door leaf, thumb turn cylinder, economy, with a silver blockade; optionally, for an additional charge, a black, magnetic lock

GLAZING

- standard 4 mm clear or milk tempered glass and for an additional charge VSG 221 milk glass or black **NEW** safety glass, smooth on both sides
- possibility to change the glazing side to REVERSE (OBSERVE - standard glazing)

AVAILABLE SOLUTIONS (p. 135-143)

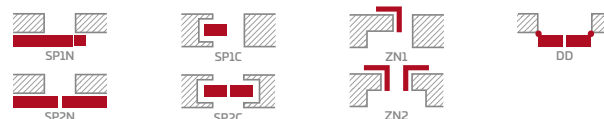

AVAILABLE DOOR LEAF WIDTHS

60 70 80 90 100

EXTRA CHARGES

free of charge factory drilled through holes for the handles (split handles) ordered in the package with the leaf **NEW**

ventilation cut

plastic woodgrain sleeves (4 pcs)

round or square metal sleeves (4 pcs); brushed nickel, patina, black or white

ventilation grille (only for door leaf widths of 80, 90, 100)

"100" rebated and non-rebated door leaf

frosted or black VSG 221 **NEW** laminated safety glass, smooth on both sides

metal hinge casings in rebated door leaf (colour: brushed nickel, patina, glossy chrome, glossy brass, white or black)

drop-down gasket ²⁾

can be replaced with a black magnetic lock for non-rebated door leaves

magnetic stop (buffer) ²⁾ **NEW**
(available in six colours p. 132)

GREKO

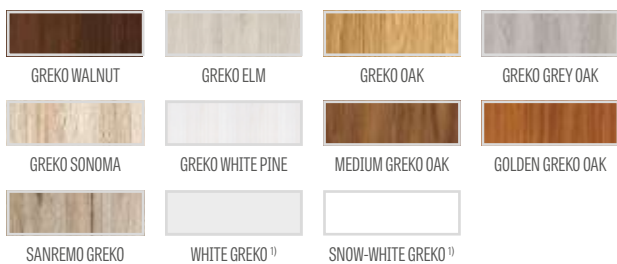

PREMIUM

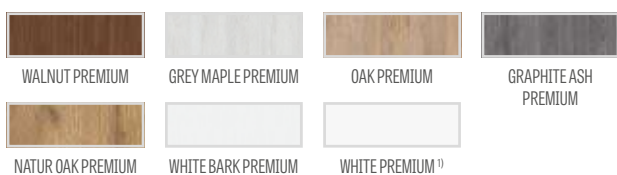

CPL

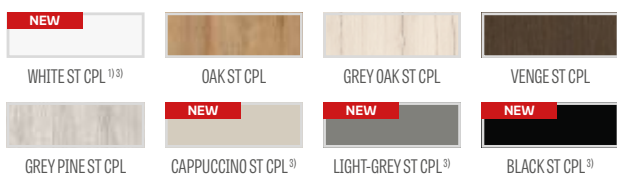

MDF stile for the GREKO and CPL laminates with the AntiFinger coating **NEW** Glulam wood stile for the PREMIUM and CPL laminates without the AntiFinger coating

¹⁾ plain white laminate imitating a painted surface

²⁾ a stop prevents application of a drop-down gasket and vice versa

³⁾ special AntiFinger **NEW** coating to reduce dirt and fingerprints



FLOKS

REBATED AND NON-REBATED INTERIOR STILE DOOR LEAVES



FLOKS 8, decor: OAK ST CPL, brushed chrome CUBE handle, matt



FLOKS 1



FLOKS 2



FLOKS 3



FLOKS 4



FLOKS 5



FLOKS 6



FLOKS 7



FLOKS 8

FLOKS 1 in OAK ST CPL finish with matt brushed chrome CUBE handle



CONSTRUCTION

- rebated or non-rebated door leaf made in the STILE technology
- MDF board vertical stiles covered with the GREKO and CPL laminate with the AntiFinger **NEW** coating and vertical glulam stiles covered with thin HDF panels and the PREMIUM or CPL laminate without the AntiFinger coating
- 4mm thick HDF panels with GREKO, CPL or PREMIUM finish
- brushed aluminium insert profiles
- optionally, upon extra charge, upper panels extending the frame – page 134

HARDWARE

- rebated door leaves: three silver 2-pin hinges adjusted horizontally
- three concealed hinges in a non-rebated leaf, silver (optionally black - subject to an additional charge); hinges supplied with and included in the price of the door frame
- deadbolt lock in a rebated door leaf and a key-locked magnetic lock in a non-rebated door leaf, thumb turn cylinder, economy, with a silver blockade; optionally, for an additional charge, a black, magnetic lock

GLAZING

- standard 4 mm clear or milk tempered glass and for an additional charge VSG 221 milk glass or black safety glass, smooth on both sides
- possibility to change the glazing side to REVERSE (OBSERVE - standard glazing)

AVAILABLE SOLUTIONS (p. 135-143)

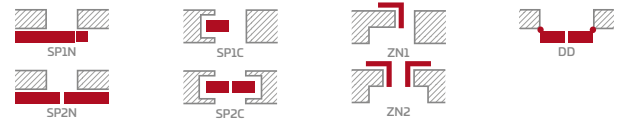

AVAILABLE DOOR LEAF WIDTHS

60 70 80 90 100

EXTRA CHARGES

free of charge factory drilled through holes for the handles (split handles) ordered in the package with the leaf **NEW**

ventilation cut

plastic woodgrain sleeves (4 pcs)

round or square metal sleeves (4 pcs); brushed nickel, patina, black or white

ventilation grille (only for door leaf widths of 80, 90, 100)

"100" rebated and non-rebated door leaf

frosted or black VSG 221 laminated safety glass, smooth on both sides

metal hinge casings in rebated door leaf (colour: brushed nickel, patina, glossy chrome, glossy brass, white or black)

drop-down gasket ²⁾

can be replaced with a black magnetic lock for non-rebated door leaves

magnetic stop (buffer) ²⁾ **NEW**
(available in six colours p. 132)

GREKO

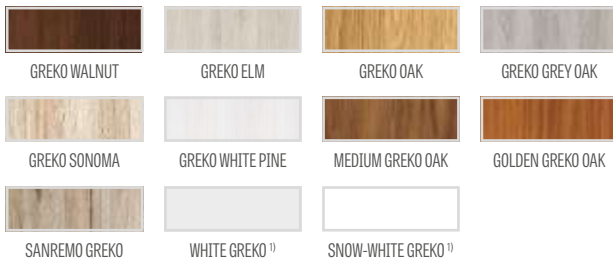

PREMIUM

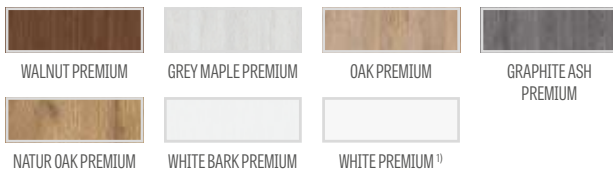

CPL

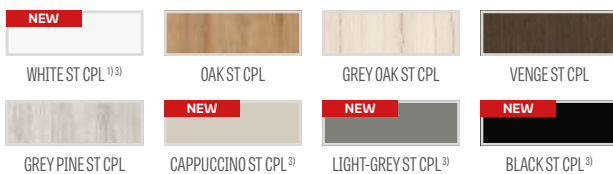

MDF stile for the GREKO and CPL laminates with the AntiFinger coating **NEW** Glulam wood stile for the PREMIUM and CPL laminates without the AntiFinger coating

¹⁾ plain white laminate imitating a painted surface

²⁾ a stop prevents application of a drop-down gasket and vice versa

³⁾ special AntiFinger **NEW** coating to reduce dirt and fingerprints



KROKUS

REBATED AND NON-REBATED INTERIOR STILE DOOR LEAVES



KROKUS 1, decor: GREKO WALNT, DECO handle



KROKUS 1



KROKUS 2



KROKUS 3



KROKUS 4



KROKUS 5



KROKUS 6

KROKUS 4 with WALNUT GREKO laminate and DECO handle



CONSTRUCTION

- rebated or non-rebated door leaf made in the STILE technology
- MDF board vertical stiles covered with the GREKO and CPL laminate with the AntiFinger **NEW** coating and vertical glulam stiles covered with thin HDF panels and the PREMIUM or CPL laminate without the AntiFinger coating
- 4mm thick HDF panels with GREKO, CPL or PREMIUM finish
- brushed aluminium insert profiles
- optionally, upon extra charge, upper panels extending the frame – page 134

HARDWARE

- rebated door leaves: three silver 2-pin hinges adjusted horizontally
- three concealed hinges in a non-rebated leaf, silver (optionally black - subject to an additional charge); hinges supplied with and included in the price of the door frame
- deadbolt lock in a rebated door leaf and a key-locked magnetic lock in a non-rebated door leaf, thumb turn cylinder, economy, with a silver blockade; optionally, for an additional charge, a black, magnetic lock

GLAZING

- standard 4 mm clear or milk tempered glass and for an additional charge VSG 221 milk glass or black **NEW** safety glass, smooth on both sides
- possibility to change the glazing side to REVERSE (OBSERVE - standard glazing)

AVAILABLE SOLUTIONS (p. 135-143)

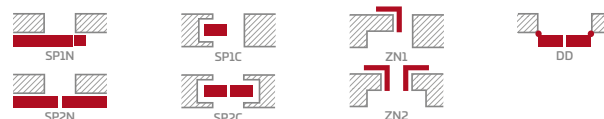

AVAILABLE DOOR LEAF WIDTHS

60 70 80 90 100

EXTRA CHARGES

free of charge factory drilled through holes for the handles (split handles) ordered in the package with the leaf **NEW**

ventilation cut

plastic woodgrain sleeves (4 pcs)

round or square metal sleeves (4 pcs); brushed nickel, patina, black or white

ventilation grille (only for door leaf widths of 80, 90, 100)

"100" rebated and non-rebated door leaf

frosted or black VSG 221 **NEW** laminated safety glass, smooth on both sides

metal hinge casings in rebated door leaf (colour: brushed nickel, patina, glossy chrome, glossy brass, white or black)

drop-down gasket ²⁾

can be replaced with a black magnetic lock for non-rebated door leaves

magnetic stop (buffer) ²⁾ **NEW**
(available in six colours p. 132)

GREKO

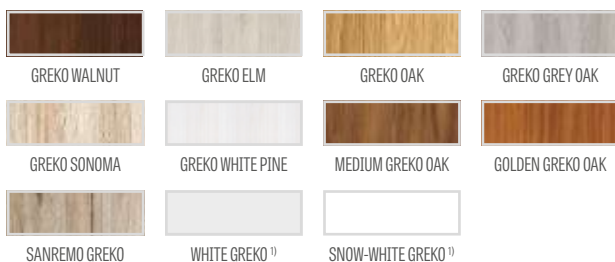

PREMIUM

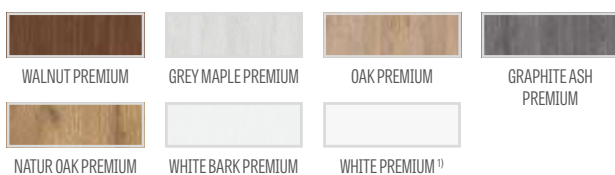

CPL

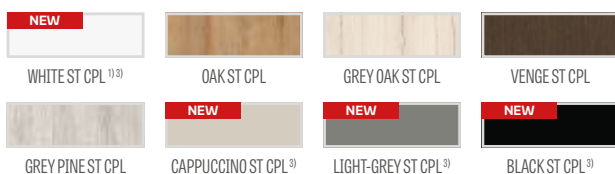

MDF stile for the GREKO and CPL laminates with the AntiFinger coating **NEW** Glulam wood stile for the PREMIUM and CPL laminates without the AntiFinger coating

¹⁾ plain white laminate imitating a painted surface

²⁾ a stop prevents application of a drop-down gasket and vice versa

³⁾ special AntiFinger **NEW** coating to reduce dirt and fingerprints



KAMELIA

REBATED AND NON-REBATED INTERIOR STILE DOOR LEAVES



KAMELIA 1, decor: GRAPHITE PREMIUM ASH, brushed chrome CUBE handle, matt



KAMELIA 1



KAMELIA 2



KAMELIA 3



KAMELIA 4



KAMELIA 5



KAMELIA 6



KAMELIA 7



KAMELIA 8

KAMELIA 1 with GRAPHITE ASH PREMIUM laminate and a brushed chrome CUBE handle, matt



GREKO

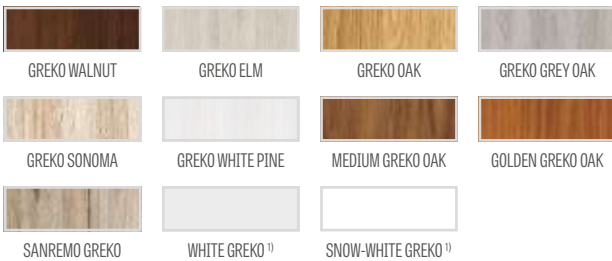

PREMIUM

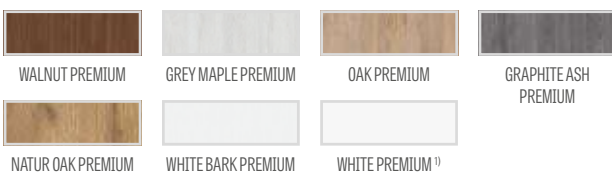

CPL

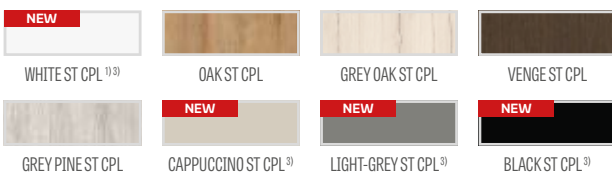

MDF stile for the GREKO and CPL laminates with the AntiFinger **NEW** coating
 Glulam wood stile for the PREMIUM and CPL laminates without the AntiFinger coating

CONSTRUCTION

- rebated or non-rebated door leaf made in the STILE technology
- MDF board vertical stiles covered with the GREKO and CPL laminate with the AntiFinger **NEW** coating and vertical glulam stiles covered with thin HDF panels and the PREMIUM or CPL laminate without the AntiFinger coating
- 4mm thick HDF panels with GREKO, CPL or PREMIUM finish
- optionally, upon extra charge, upper panels extending the frame – page 134

HARDWARE

- rebated door leaves: three silver 2-pin hinges adjusted horizontally
- three concealed hinges in a non-rebated leaf, silver (optionally black - subject to an additional charge); hinges supplied with and included in the price of the door frame
- deadbolt lock in a rebated door leaf and a key-locked magnetic lock in a non-rebated door leaf, thumb turn cylinder, economy, with a silver blockade; optionally, for an additional charge, a black, magnetic lock

GLAZING

- standard 4 mm clear or milk tempered glass and for an additional charge VSG 221 milk glass or black **NEW** safety glass, smooth on both sides
- possibility to change the glazing side to REVERSE (OBSERVE - standard glazing)

AVAILABLE SOLUTIONS (p. 135-143)

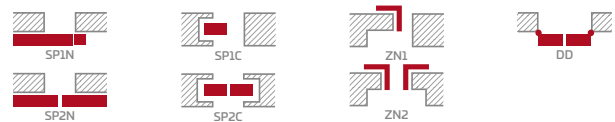

AVAILABLE DOOR LEAF WIDTHS



EXTRA CHARGES

free of charge factory drilled through holes for the handles (split handles) ordered in the package with the leaf **NEW**

ventilation cut

plastic woodgrain sleeves (4 pcs)

round or square metal sleeves (4 pcs); brushed nickel, patina, black or white

ventilation grille (only for door leaf widths of 80, 90, 100)

"100" rebated and non-rebated door leaf

frosted or black VSG 221 **NEW** laminated safety glass, smooth on both sides

metal hinge casings in rebated door leaf (colour: brushed nickel, patina, glossy chrome, glossy brass, white or black)

drop-down gasket ²⁾

can be replaced with a black magnetic lock for non-rebated door leaves

magnetic stop (buffer) ²⁾ **NEW**
 (available in six colours p. 132)

¹⁾ plain white laminate imitating a painted surface

²⁾ a stop prevents application of a drop-down gasket and vice versa

³⁾ special AntiFinger **NEW** coating to reduce dirt and fingerprints



PETUNIA

REBATED AND NON-REBATED INTERIOR STILE DOOR LEAVES



PETUNIA 1, decor: OAK PREMIUM, TOPAZ INOX handle



PETUNIA 1



PETUNIA 2



PETUNIA 3



PETUNIA 4



PETUNIA 5



PETUNIA 6



PETUNIA 7



PETUNIA 8

PETUNIA 1 with OAK PREMIUM laminate and a TOPAZ INOX handle



GREKO

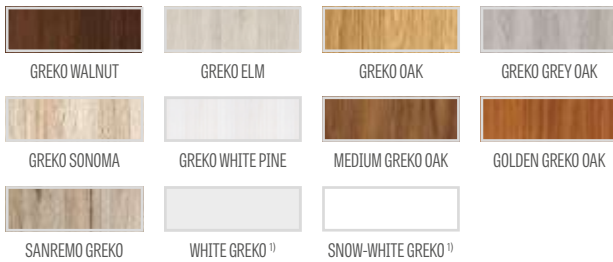

PREMIUM

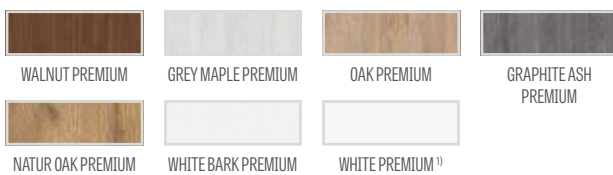

CPL

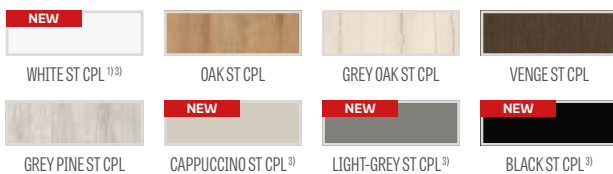

MDF stile for the GREKO and CPL laminates with the AntiFinger coating **NEW** Glulam wood stile for the PREMIUM and CPL laminates without the AntiFinger coating

CONSTRUCTION

- rebated or non-rebated door leaf made in the STILE technology
- MDF board vertical stiles covered with the GREKO and CPL laminate with the AntiFinger **NEW** coating and vertical glulam stiles covered with thin HDF panels and the PREMIUM or CPL laminate without the AntiFinger coating
- 4mm thick HDF panels with GREKO, CPL or PREMIUM finish
- optionally, upon extra charge, upper panels extending the frame – page 134

HARDWARE

- rebated door leaves: three silver 2-pin hinges adjusted horizontally
- three concealed hinges in a non-rebated leaf, silver (optionally black - subject to an additional charge); hinges supplied with and included in the price of the door frame
- deadbolt lock in a rebated door leaf and a key-locked magnetic lock in a non-rebated door leaf, thumb turn cylinder, economy, with a silver blockade; optionally, for an additional charge, a black, magnetic lock

GLAZING

- standard 4 mm clear or milk tempered glass and for an additional charge VSG 221 milk glass or black **NEW** safety glass, smooth on both sides
- possibility to change the glazing side to REVERSE (OBSERVE - standard glazing)

AVAILABLE SOLUTIONS (p. 135-143)

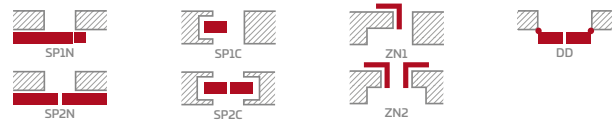

AVAILABLE DOOR LEAF WIDTHS

60 70 80 90 100

EXTRA CHARGES

free of charge factory drilled through holes for the handles (split handles) ordered in the package with the leaf **NEW**

ventilation cut

plastic woodgrain sleeves (4 pcs)

round or square metal sleeves (4 pcs); brushed nickel, patina, black or white

ventilation grille (only for door leaf widths of 80, 90, 100)

"100" rebated and non-rebated door leaf

frosted or black VSG 221 **NEW** laminated safety glass, smooth on both sides

metal hinge casings in rebated door leaf (colour: brushed nickel, patina, glossy chrome, glossy brass, white or black)

drop-down gasket ²⁾

can be replaced with a black magnetic lock for non-rebated door leaves

magnetic stop (buffer) ²⁾ **NEW**
(available in six colours p. 132)

¹⁾ plain white laminate imitating a painted surface

²⁾ a stop prevents application of a drop-down gasket and vice versa

³⁾ special AntiFinger **NEW** coating to reduce dirt and fingerprints



AZALIA

REBATED AND NON-REBATED INTERIOR STILE DOOR LEAVES



AZALIA 1, decor: OAK ST CPL, CUBE handle - bushed chrome, matt



AZALIA 1



AZALIA 2



AZALIA 3



AZALIA 4



AZALIA 5



AZALIA 6



AZALIA 7



AZALIA 8

AZALIA 6 with OAK ST CPL laminate and a brushed chrome CUBE handle, matt



CONSTRUCTION

- rebated or non-rebated door leaf made in the STILE technology
- MDF board vertical stiles covered with the GREKO and CPL laminate with the AntiFinger **NEW** coating and vertical glulam stiles covered with thin HDF panels and the PREMIUM or CPL laminate without the AntiFinger coating
- 4mm thick HDF panels with GREKO, CPL or PREMIUM finish
- optionally, upon extra charge, upper panels extending the frame – page 134

HARDWARE

- rebated door leaves: three silver 2-pin hinges adjusted horizontally
- three concealed hinges in a non-rebated leaf, silver (optionally black - subject to an additional charge); hinges supplied with and included in the price of the door frame
- deadbolt lock in a rebated door leaf and a key-locked magnetic lock in a non-rebated door leaf, thumb turn cylinder, economy, with a silver blockade; optionally, for an additional charge, a black, magnetic lock

GLAZING

- standard 4 mm clear or milk tempered glass and for an additional charge VSG 221 milk glass or black **NEW** safety glass, smooth on both sides
- possibility to change the glazing side to REVERSE (OBSERVE - standard glazing)

AVAILABLE SOLUTIONS (p. 135-143)

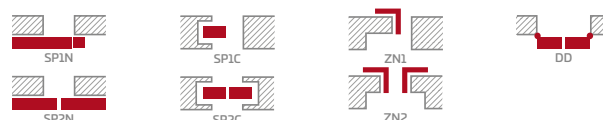

AVAILABLE DOOR LEAF WIDTHS

60 70 80 90 100

EXTRA CHARGES

free of charge factory drilled through holes for the handles (split handles) ordered in the package with the leaf **NEW**

ventilation cut

plastic woodgrain sleeves (4 pcs)

round or square metal sleeves (4 pcs); brushed nickel, patina, black or white

ventilation grille (only for door leaf widths of 80, 90, 100)

"100" rebated and non-rebated door leaf

frosted or black VSG 221 **NEW** laminated safety glass, smooth on both sides

metal hinge casings in rebated door leaf (colour: brushed nickel, patina, glossy chrome, glossy brass, white or black)

drop-down gasket ²⁾

can be replaced with a black magnetic lock for non-rebated door leaves

magnetic stop (buffer) ²⁾ **NEW**
(available in six colours p. 132)

GREKO

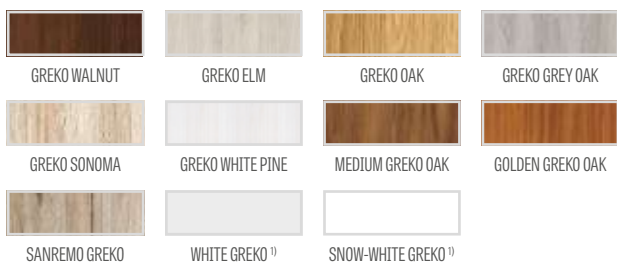

PREMIUM

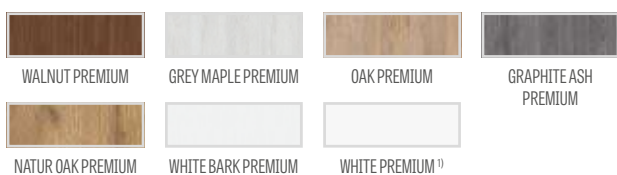

CPL

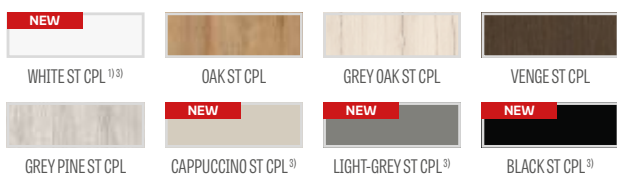

MDF stile for the GREKO and CPL laminates with the AntiFinger coating **NEW** | Glulam wood stile for the PREMIUM and CPL laminates without the AntiFinger coating

¹⁾ plain white laminate imitating a painted surface

²⁾ a stop prevents application of a drop-down gasket and vice versa

³⁾ special AntiFinger **NEW** coating to reduce dirt and fingerprints



HIACYNT

REBATED AND NON-REBATED INTERIOR STILE DOOR LEAVES



HIACYNT 6, decor: MEDIUM GREKO OAK, TOPAZ INOX handle



HIACYNT 1



HIACYNT 2



HIACYNT 3



HIACYNT 4



HIACYNT 5



HIACYNT 6



HIACYNT 7



HIACYNT 8

HIACYNT 1 with MEDIUM GREKO OAK laminate and a TOPAZ INOX handle



CONSTRUCTION

- rebated or non-rebated door leaf made in the STILE technology
- MDF board vertical stiles covered with the GREKO and CPL laminate with the AntiFinger **NEW** coating and vertical glulam stiles covered with thin HDF panels and the PREMIUM or CPL laminate without the AntiFinger coating
- 22 mm thick HDF panels with GREKO, CPL or PREMIUM finish
- optionally, upon extra charge, upper panels extending the frame – page 134

HARDWARE

- rebated door leaves: three silver 2-pin hinges adjusted horizontally
- three concealed hinges in a non-rebated leaf, silver (optionally black - subject to an additional charge); hinges supplied with and included in the price of the door frame
- deadbolt lock in a rebated door leaf and a key-locked magnetic lock in a non-rebated door leaf, thumb turn cylinder, economy, with a silver blockade; optionally, for an additional charge, a black, magnetic lock

GLAZING

- standard 4 mm clear or milk tempered glass and for an additional charge VSG 221 milk glass or black **NEW** safety glass, smooth on both sides
- possibility to change the glazing side to REVERSE (OBSERVE - standard glazing)

AVAILABLE SOLUTIONS (p. 135-143)

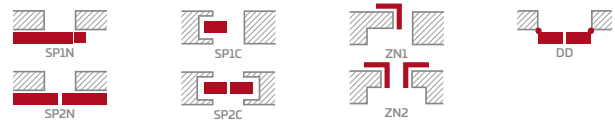

AVAILABLE DOOR LEAF WIDTHS

60 70 80 90 100

EXTRA CHARGES

free of charge factory drilled through holes for the handles (split handles) ordered in the package with the leaf **NEW**

ventilation cut

plastic woodgrain sleeves (4 pcs)

round or square metal sleeves (4 pcs); brushed nickel, patina, black or white

ventilation grille (only for door leaf widths of 80, 90, 100)

"100" rebated and non-rebated door leaf

frosted or black **NEW** VSG 221 laminated safety glass, smooth on both sides

metal hinge casings in the rebated door leaf (brushed nickel, patina, polished chrome, polished brass, white or black)

drop-down gasket ²⁾

can be replaced with a black magnetic lock for non-rebated door leaves

magnetic stop (buffer) ²⁾ **NEW**
(available in six colours p. 132)

GREKO

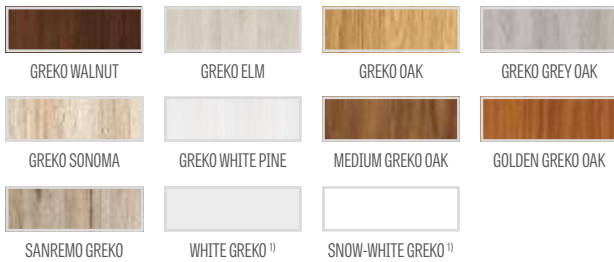

PREMIUM

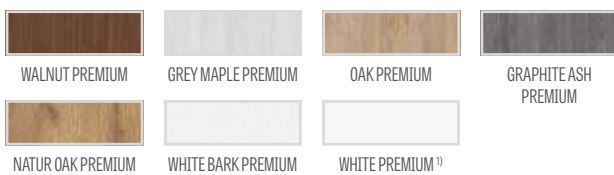

CPL

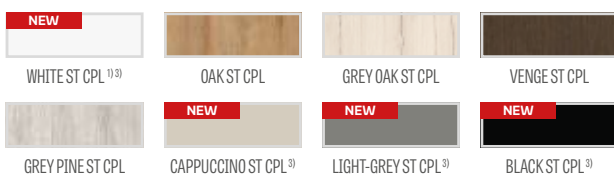

MDF stile for the GREKO and CPL laminates with the AntiFinger coating **NEW** Glulam wood stile for the PREMIUM and CPL laminates without the AntiFinger coating

¹⁾ plain white laminate imitating a painted surface

²⁾ a stop prevents application of a drop-down gasket and vice versa

³⁾ special AntiFinger **NEW** coating to reduce dirt and fingerprints



FRAGI

REBATED INTERIOR STILE DOORS



WHITE ST CPL Finish, black matt CUBE handle, black VSG glass



FRAGI 1



FRAGI 4
DECORMAT



FRAGI 5
TRANSPARENT



FRAGI 7
DECORMAT GRAFIT



FRAGI 9



FRAGI 10



FRAGI 15
Frosted VSG/ESG



FRAGI 16
Black VSG/ESG

FRAGI 4 with WALNUT GREKO laminate and DECO handle



CONSTRUCTION

- rebated door leaf made in STILE technology
- MDF board vertical stiles covered with the GREKO and CPL laminate with the AntiFinger **NEW** coating and vertical glulam stiles covered with thin HDF panels and the PREMIUM or CPL laminate without the AntiFinger coating
- optionally, upon extra charge, upper panels extending the frame – page 134

HARDWARE

- rebated door leaves: three silver 2-pin hinges adjusted horizontally
- a deadbolt lock, euro profile cylinder, economy lock or with a thumb turn

GLAZING

- 8 mm tempered or tempered and VSG/ESG 441 laminated safety glass, frosted or black, smooth on both sides (for FRAGI 15 & FRAGI 16 models)
- possibility to change the glazing side to REVERSE (OBSERVE - standard glazing)

AVAILABLE SOLUTIONS (p. 144-146)



AVAILABLE DOOR LEAF WIDTHS

60 70 80 90

EXTRA CHARGES

free of charge factory drilled through holes for the handles (split handles) ordered in the package with the leaf **NEW**

ventilation cut

metal hinge casings in rebated door leaf
(colour: brushed nickel, patina, glossy chrome, glossy brass, white or black)

magnetic stop (buffer) **NEW**
(available in six colours p. 132)

Note:

The picture shows only an 80cm-wide door leaf. The proportion in the picture differ slightly for the other FRAGI 1 model widths. For further details and photos go to our website: www.erkado.pl

STANDARD "OBSERVE" GLAZING

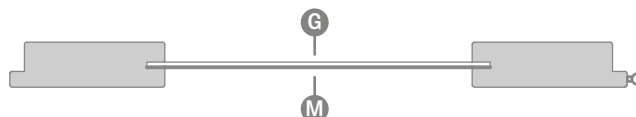

"REVERSE" GLAZING MADE TO ORDER

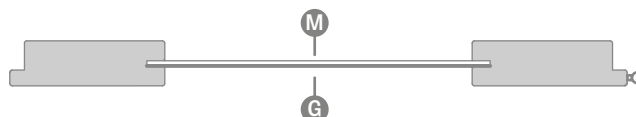

G Plain side; **M** ornamented matt side;

GREKO

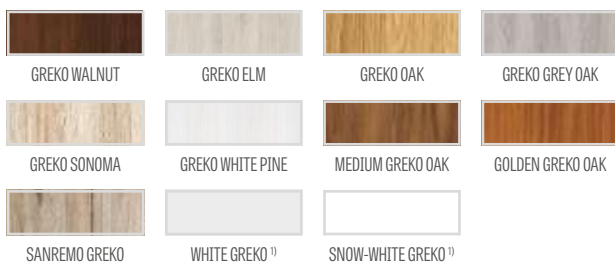

PREMIUM

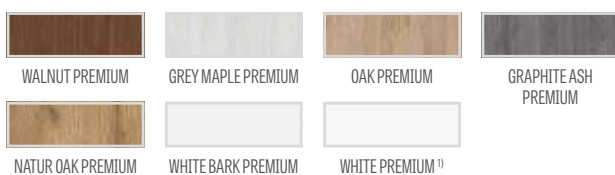

CPL

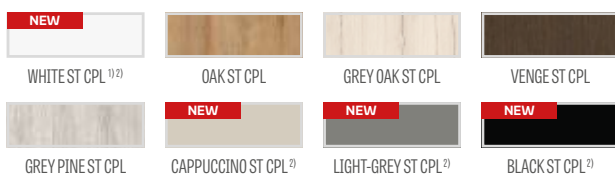

MDF stile for the GREKO and CPL laminates with the AntiFinger **NEW** coating
Glulam wood stile for the PREMIUM and CPL laminates without the AntiFinger coating

¹⁾ plain white laminate imitating a painted surface

²⁾ special AntiFinger **NEW** coating to reduce dirt and fingerprints



GRAF GLASS DOORS

INTERIOR GLASS DOORS



GRAF 1



GRAF 6



GRAF 8 DECORMAT



GRAF 9 TRANSPARENT



GRAF 11 DECORMAT GRAPHITE



GRAF 17



GRAF 22



GRAF 26 DARK GREY



GRAF 32



GRAF 35



GRAF 36



GRAF 38

GLAZING TRANSLUCENCY ILLUSTRATION on p. 133

GRAF 36 with BLACK ST CPL laminate



CONSTRUCTION

- 8 mm tempered glass, 8 mm tinted glass (GRAF 26)
- possibility to change the glazing side to REVERSE (OBSERVE - standard glazing)
- frosted or clear glass with black or white painted decorative patterns
- the line width (thickness) of the GRAF 1, 6, 17, 35, 36, 38 models is 30 mm
- optionally, upon extra charge, upper panels extending the frame – page 134

FIXED AND ADJUSTABLE FRAMES

- for prices of fixed and adjustable frames for rebated doors go to p. 161-163
- no electric strike possible
- 10 mm pin hinge for glass panes frames
- in the fixed and adjustable frame, it is possible to change the black powder-coated striker plate (at an extra charge)
- **ONLY REBATED FRAMES IN ALL AVAILABLE DECORS, STEEL FRAMES AND THE WHITE PAINTED TITANIUM UV FRAME ARE AVAILABLE FOR GLASS GRAF DOORS**

NOTE: For the extended Glass Door Collection and a variety of available models go to our website: www.erkado.pl. You can also order the available models through the B2B panel.

AVAILABLE DOOR LEAF WIDTHS

60 70 80 90 (charged extra)



See more at www.erkado.pl

EXTRA CHARGES

“90” door leaf

ventilation cut

black striker plate

METAL-BUD HARDWARE stainless steel

Metal-Bud

PRODUCENT KLAMEK

Available shapes: oval or rectangle



2A OVAL



3A OVAL



1A OVAL



4AZ EXTERNAL OVAL ¹⁾
4AW INTERNAL OVAL



OVAL HINGE



2B RECTANGLE



3B RECTANGLE



1B RECTANGLE



4BZ OUTSIDE RECTANGLE ¹⁾
4BW INTERNAL RECTANGLE



RECTANGLE HINGE

¹⁾ detailed description of bathroom fittings selection (lock with a blockade) page 131



LAMELLAS

WALL-MOUNTED



Wall lamellas: decorative strip OAK ST CPL, adapter BLACK ST CPL, skirting board OAK ST CPL, door BALDUR 3 OAK ST CPL, black VSG glass

Decorative lamellas are mounted on the wall as a decorative element and at the same time improve the acoustics in the room.

Mounting is possible in several ways - the decorative skirting board can be mounted to the wall by means of a mounting strip only or with the use of adapters which constitute a base for the panels.

Decorative lamellas are available with PREMIUM and ST CPL laminates and can be joined in selected combinations.



components of wall lamellas



composition of decorative lamellas with the skirting board OAK ST CPL

DECORATIVE STRIP

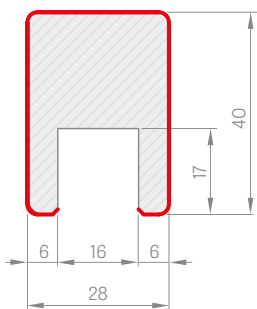

MOUNTING STRIP

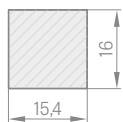

END STRIP

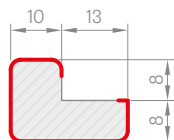

DECORATIVE LAMELLA

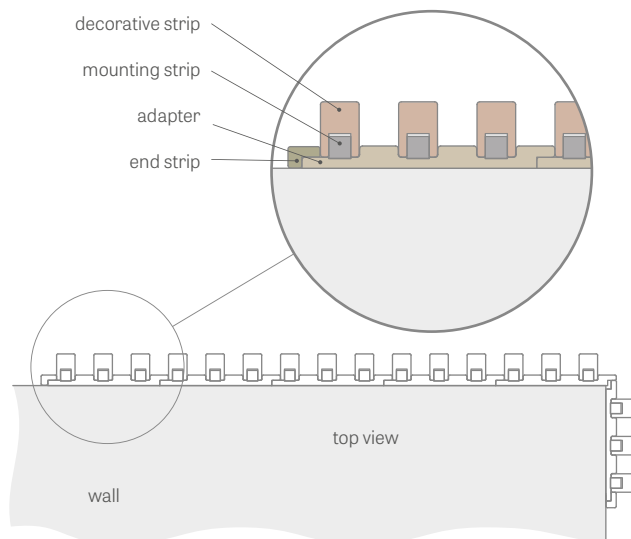

ADAPTER

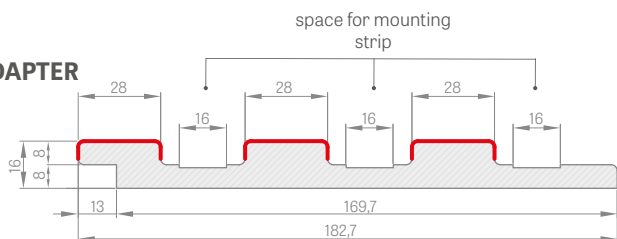

— Laminate

Installation vide variant with an adapter: <https://youtu.be/p317u3cWMmg>



Installation vide no adapter variant: <https://youtu.be/jFa5afWWFOM>



ST CPL & PREMIUM
adapter, length 2750 mm
decorative strip (mounting strip included), length 2750 mm
end strip, length 2750 mm

PREMIUM				
WALNUT PREMIUM	GREY MAPLE PREMIUM	OAK PREMIUM	WHITE BARK PREMIUM	GRAPHITE ASH PREMIUM
CONCRETE PREMIUM	NATUR OAK PREMIUM	WHITE PREMIUM 1)		

CPL				
OAK ST CPL	GREY OAK ST CPL	VENGE ST CPL	GREY PINE ST CPL	WHITE ST CPL 1)2)
CAPPUCCINO ST CPL 2)	LIGHT-GREY ST CPL 2)	BLACK ST CPL 2)		

The individual elements of the decorative lamella system are commercially available in a length of 2750 mm, however each product has a production length of 2800 mm and is delivered in this length, where 25 mm per side is a margin for free trimming before installation and also a reserve in case of transport damage.

The wall lamellas can also be mounted without an adapter directly to the wall using only a mounting strip on which we mount the decorative strip. Decorative strip (with the mounting strip included) can be purchased only in multiple of 3 pieces, e.g. 3 pcs, 6 pcs, 9 pcs, etc.

- adapter - quantity in pack 1 piece
- end strip - package quantity 1 piece
- decorative strip + mounting strip - pack of 3 pcs + 3 pcs

SKIRTING BOARDS

SKIRTING BOARD

- length: 2.40 running metres.
- laminated
- lacquered
- The skirting board is made of moisture resistant MDF board. Available variants: WHITE TITANIUM UV paint, laminates: GREKO, ST CPL, PREMIUM and in base laminate to be paint coated.
- Fitting method: bonding to wall



1) plain white laminate imitating a painted surface
 2) special **AntiFinger** **NEW** coating to reduce dirt and fingerprints



BALDUR

REBATED, NON-REBATED AND REVERSE PAINTED DOORS



BALDUR 1 with a CUBE PREMIUM handle and black VSG 441 laminated glass



BALDUR 1



BALDUR 2



BALDUR 3



BALDUR 4



BALDUR 5



BALDUR 6



BALDUR 7



BALDUR 8

BALDUR 7 with the CUBE PREMIUM handle



PAINTED



WHITE TITANIUM UV

AVAILABLE SOLUTIONS ¹⁾³⁾ (p. 135-143)

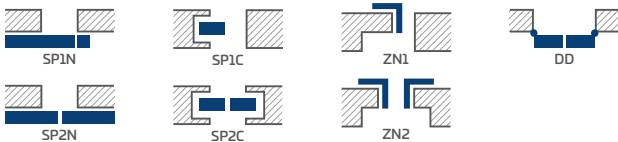

AVAILABLE DOOR LEAF WIDTHS

60 70 80 90 100

MOULDING

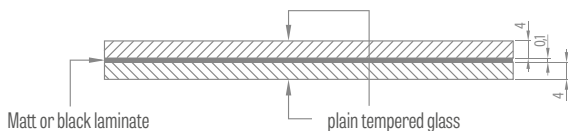
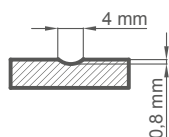

VSG/ESG laminated and tempered glass as a standard, frosted or black

CONSTRUCTION

- rebated, non-rebated or reverse door leaf
- internal timber stile (sides and top, bottom -MDF) covered with two HDF boards
- honeycomb stabilising filling or solid core filling for an additional charge
- optionally, upon extra charge, upper panels extending the frame – page 134

FINISHING

- door leaves and door frames coated with water-based UV hardened varnish for high resistance to adverse use conditions
- door leaf edge made in standard or non-rebated technology
- the BALDUR 1 sliding systems have a visible 17 mm high aluminium or black coloured profile in the lower part of the glass pane

HARDWARE

- three pin mortise hinges in a rebated door leaf
- three concealed hinges in the non-adjacent leaf and two hinges in the reverse leaf in silver (black for an extra charge); hinges are supplied and priced with the door frame
- a deadbolt lock in the rebated door leaf and a key-locked magnetic lock in the non-rebated and reverse door leaves, thumb turn cylinder, economy or silver with a blockade or, optionally, for an additional charge, a black magnetic lock

GLAZING

- **BALDUR 1, 3, 5: SG/ESG 441 laminated and tempered safetyglass as a standard, frosted or black, smooth on both sides**
- fixed glazing widths: BALDUR 1 – 50 mm, BALDUR 3, 5 – 210 mm

EXTRA CHARGES

reverse door leaf

solid core filling

ventilation cut

"100" rebated and non-rebated door leaf

additional bottom allowing the user to shorten the leaf up to 8 cm (not applicable to Baldur 1, 3, 5)

metal hinge casings in the rebated door leaf (brushed nickel, patina, polished chrome, polished brass, white or black)

drop-down gasket ²⁾ (not for the BALDUR 1, 3, 5 models)

can be replaced with a black magnetic lock for non-rebated and reverse leaves

magnetic stop (buffer) ²⁾ **NEW**
(available in six colours p. 132)

VENTILATION CUT

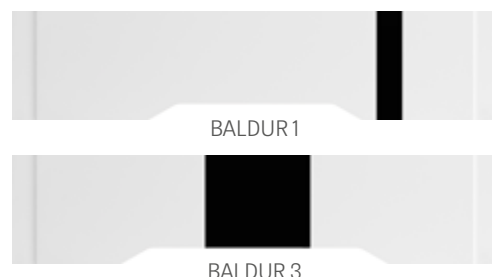

¹⁾ BALDUR 1, 3, 5 models are not available with sliding systems or double-leaf doors

²⁾ a stop prevents application of a drop-down gasket and vice versa

³⁾ BALDUR 1 model is not available with pocket systems



MISKANT

REBATED, NON-REBATED PAINTED DOORS



MISKANT 2, BELLA slim black matt handle



MISKANT 1



MISKANT 2



MISKANT 3



MISKANT 4



MISKANT 5



MISKANT 6



MISKANT 4 with BELLA slim black matt handle

CONSTRUCTION

- rebated or non-rebated door leaf made in the STILE technology
- timber stiles covered with thin HDF boards and laminated and coated with UV resistant varnish
- optionally, upon extra charge, upper panels extending the frame – page 134

FINISHING

- door leaves and door frames coated with water-based UV hardened varnish for high resistance to adverse use conditions

HARDWARE

- rebated door leaves: three silver 2-pin hinges adjusted horizontally
- three concealed hinges in a non-rebated leaf, silver (optionally black - subject to an additional charge); hinges supplied with and included in the price of the door frame
- deadbolt lock in a rebated door leaf and a key-locked magnetic lock in a non-rebated door leaf, thumb turn cylinder, economy, with a silver blockade; optionally, for an additional charge, a black, magnetic lock

GLAZING

- toughened transparent or frosted glass with a thickness of 4 mm
- possibility to change the glazing side to REVERSE (OBVERSE - standard glazing)
- painted black lines of 18 mm in width (thickness)

STANDARD “OBVERSE” GLAZING



“REVERSE” GLAZING MADE TO ORDER



PAINTED



WHITE TITANIUM UV

EXTRA CHARGES

free of charge factory drilled through holes for the handles (split handles) ordered in the package with the leaf **NEW**

ventilation cut

“100” rebated and non-rebated door leaf

metal hinge casings in the rebated door leaf (brushed nickel, patina, polished chrome, polished brass, white or black)

drop-down gasket ¹⁾

can be replaced with a black magnetic lock for non-rebated door leaves

magnetic stop (buffer) ¹⁾ **NEW**
(available in six colours p. 132)

AVAILABLE SOLUTIONS (p. 135-143)

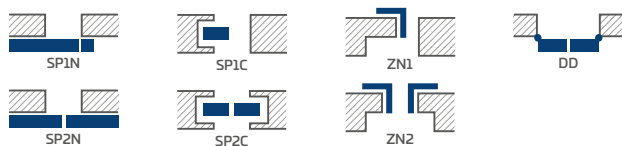

AVAILABLE DOOR LEAF WIDTHS

- 60
- 70
- 80
- 90
- 100

¹⁾ a stop prevents application of a drop-down gasket and vice versa



NEMEZJA

REBATED, NON-REBATED PAINTED DOORS



NEMEZJA 8, BELLA handle slim brass glossy



NEMEZJA 1



NEMEZJA 4



NEMEZJA 7



NEMEZJA 8



NEMEZJA 9



NEMEZJA 10



NEMEZJA 11



NEMEZJA 12



NEMEZJA 13



NEMEZJA 14

NEMEZJA 6 with BELLA handle slim brass glossy



PAINTED

WHITE TITANIUM UV

AVAILABLE SOLUTIONS (p. 135-143)



SP1N



SP1C



ZN1



DD

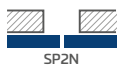

SP2N



SP2C



ZN2

AVAILABLE DOOR LEAF WIDTHS

60

70

80

90

100

CONSTRUCTION

- rebated or non-rebated door leaf made in the STILE technology
- timber stiles covered with thin HDF boards and laminated and coated with UV resistant varnish
- 16 mm thick HDF panels, moulded and coated with UV resistant varnish
- optionally, upon extra charge, upper panels extending the frame – page 134

FINISHING

- door leaves and door frames coated with water-based UV hardened varnish for high resistance to adverse use conditions

HARDWARE

- rebated door leaves: three silver 2-pin hinges adjusted horizontally
- three concealed hinges in a non-rebated leaf, silver (optionally black - subject to an additional charge); hinges supplied with and included in the price of the door frame
- deadbolt lock in a rebated door leaf and a key-locked magnetic lock in a non-rebated door leaf, thumb turn cylinder, economy, with a silver blockade; optionally, for an additional charge, a black, magnetic lock

GLAZING

- frosted or transparent tempered glass as standard, and frosted or black VSG 221 laminated safety glass at an extra charge, smooth on both sides
- possibility to change the glazing side to REVERSE (OBSERVE - standard glazing)

EXTRA CHARGES

free of charge factory drilled through holes for the handles (split handles) ordered in the package with the leaf **NEW**

ventilation cut

"100" rebated and non-rebated door leaf

metal hinge casings in the rebated door leaf (brushed nickel, patina, polished chrome, polished brass, white or black)

frosted or black VSG 221 laminated safety glass, smooth on both sides

drop-down gasket ¹⁾

can be replaced with a black magnetic lock for non-rebated door leaves

magnetic stop (buffer) ¹⁾ **NEW**
(available in six colours p. 132)

¹⁾ a stop prevents application of a drop-down gasket and vice versa



LAURENCJA

REBATED, NON-REBATED PAINTED DOORS



LAURENCJA 1, black VSG glass, matt BELLA handle, black



LAURENCJA 1



LAURENCJA 2



LAURENCJA 3



LAURENCJA 4



LAURENCJA 5



LAURENCJA 6

LAURENCJA 1 with a BELLA slim handle, black matt, and VSG 221 laminated glass, black



PAINTED

WHITE TITANIUM UV

AVAILABLE SOLUTIONS (p. 135-143)

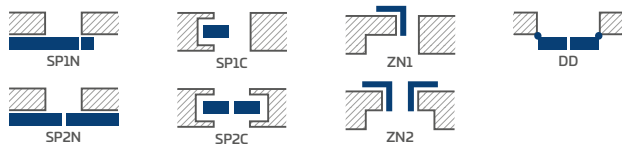

AVAILABLE DOOR LEAF WIDTHS

60 70 80 90 100

CONSTRUCTION

- rebated or non-rebated door leaf made in the STILE technology
- timber stiles covered with thin HDF boards and laminated and coated with UV resistant varnish
- 4 mm thick HDF panels, moulded and coated with UV resistant varnish
- optionally, upon extra charge, upper panels extending the frame – page 134

FINISHING

- door leaves and door frames coated with water-based UV hardened varnish for high resistance to adverse use conditions

HARDWARE

- rebated door leaves: three silver 2-pin hinges adjusted horizontally
- three concealed hinges in a non-rebated leaf, silver (optionally black - subject to an additional charge); hinges supplied with and included in the price of the door frame
- deadbolt lock in a rebated door leaf and a key-locked magnetic lock in a non-rebated door leaf, thumb turn cylinder, economy, with a silver blockade; optionally, for an additional charge, a black, magnetic lock

GLAZING

- frosted or transparent tempered glass as standard, and frosted or black VSG 221 laminated safety glass at an extra charge, smooth on both sides
- possibility to change the glazing side to REVERSE (OBSERVE - standard glazing)

EXTRA CHARGES

free of charge factory drilled through holes for the handles (split handles) ordered in the package with the leaf **NEW**

ventilation cut

"100" rebated and non-rebated door leaf

metal hinge casings in the rebated door leaf (brushed nickel, patina, polished chrome, polished brass, white or black)

frosted or black VSG 221 laminated safety glass, smooth on both sides

drop-down gasket ¹⁾

can be replaced with a black magnetic lock for non-rebated door leaves

magnetic stop (buffer) ¹⁾ **NEW**
(available in six colours p. 132)

¹⁾ a stop prevents application of a drop-down gasket and vice versa



ANUBIS

REBATED, NON-REBATED AND REVERSE PAINTED DOORS



ANUBIS 2, handle: BELLA slim, shiny brass



ANUBIS 1



ANUBIS 2



ANUBIS 3



ANUBIS 4



ANUBIS 5

ANUBIS 3, handle: BELLA slim, shiny brass



CONSTRUCTION

- rebated, non-rebated or reverse door leaf
- internal timber stile (sides and top, bottom -MDF) covered with two HDF boards
- honeycomb stabilising filling or solid core filling for an additional charge
- optionally, upon extra charge, upper panels extending the frame – page 134

FINISHING

- door leaves and door frames coated with water-based UV hardened varnish for high resistance to adverse use conditions
- door leaf edge made in standard or non-rebated technology

HARDWARE

- three pin mortise hinges in a rebated door leaf
- three concealed hinges in the non-adjacent leaf and two hinges in the reverse leaf in silver (black for an extra charge); hinges are supplied and priced with the door frame
- a deadbolt lock in the rebated door leaf and a key-locked magnetic lock in the non-rebated and reverse door leaves, thumb turn cylinder, economy or silver with a blockade or, optionally, for an additional charge, a black magnetic lock

MOULDING

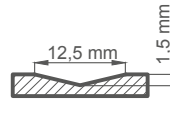

PAINTED



WHITE TITANIUM UV

AVAILABLE SOLUTIONS (p. 135-143)

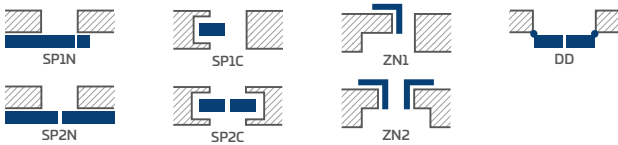

AVAILABLE DOOR LEAF WIDTHS



EXTRA CHARGES

reverse door leaf

solid core filling

ventilation cut

"100" rebated and non-rebated door leaf

additional bottom rail (can be cut by customer up to max 8 cm)

metal hinge casings in the rebated door leaf (brushed nickel, patina, polished chrome, polished brass, white or black)

drop-down gasket ¹⁾

can be replaced with a black magnetic lock for non-rebated and reverse leaves

magnetic stop (buffer) ¹⁾ **NEW**
(available in six colours p. 132)

¹⁾ a stop prevents application of a drop-down gasket and vice versa



UNO PREMIUM

REBATED, NON-REBATED AND REVERSE PAINTED DOORS



Presented model: UNO PREMIUM with black matt CUBE handle

Frame side view: non-rebated door, 8 cm architrave, frame joints at 90°



Frame side view: rebated door, 8 cm architrave, frame joints at 45°



Hinge side view: rebated door, 6 cm architrave, frame joints at 45°



UNO PREMIUM with black matt CUBE handle



CONSTRUCTION

- rebated, non-rebated or reverse door leaf
- internal timber stile (sides and top, bottom -MDF) covered with two HDF boards
- honeycomb stabilising filling or solid core filling for an additional charge
- optionally, upon extra charge, upper panels extending the frame – page 134

FINISHING

- door leaves and door frames coated with water-based UV hardened varnish for high resistance to adverse use conditions
- door leaf edge made in standard technology

HARDWARE

- three pin mortise hinges in a rebated door leaf
- three concealed hinges in the non-adjacent leaf and two hinges in the reverse leaf in silver (black for an extra charge); hinges are supplied and priced with the door frame
- a deadbolt lock in the rebated door leaf and a key-locked magnetic lock in the non-rebated and reverse door leaves, thumb turn cylinder, economy or silver with a blockade or, optionally, for an additional charge, a black magnetic lock

PAINTED



WHITE TITANIUM UV

AVAILABLE SOLUTIONS (p. 135-143)

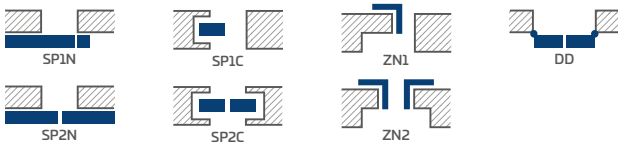

AVAILABLE DOOR LEAF WIDTHS



EXTRA CHARGES

reverse door leaf

solid core filling

ventilation cut

"100" rebated and non-rebated door leaf

additional bottom rail (can be cut by customer up to max 8 cm)

metal hinge casings in the rebated door leaf (brushed nickel, patina, polished chrome, polished brass, white or black)

drop-down gasket ¹⁾

can be replaced with a black magnetic lock for non-rebated and reverse leaves

magnetic stop (buffer) ¹⁾

NEW

(available in six colours p. 132)

stainless steel porthole: "chrome" polished or "satine" brushed; frosted decormat glass, clear glass; porthole ID 235 mm; external 350 mm)

¹⁾ a stop prevents application of a drop-down gasket and vice versa



TURAN

REBATED, NON-REBATED PAINTED DOORS



Black matt CUBE handle



TURAN 1



TURAN 2



TURAN 3



TURAN 4



TURAN 5



TURAN 6



TURAN 7¹⁾

¹⁾ the photo shows the REVERS version

TURAN 5 with CUBE handle, black, matt



CONSTRUCTION

- rebated or non-rebated door leaf made in the STILE technology
- timber stiles covered with thin HDF boards and laminated and coated with UV resistant varnish
- 16 mm thick HDF panels, moulded and coated with UV resistant varnish
- optionally, upon extra charge, upper panels extending the frame – page 134

FINISHING

- door leaves and door frames coated with water-based UV hardened varnish for high resistance to adverse use conditions

HARDWARE

- rebated door leaves: three silver 2-pin hinges adjusted horizontally
- three concealed hinges in a non-rebated leaf, silver (optionally black - subject to an additional charge); hinges supplied with and included in the price of the door frame
- deadbolt lock in a rebated door leaf and a key-locked magnetic lock in a non-rebated door leaf, thumb turn cylinder, economy, with a silver blockade; optionally, for an additional charge, a black, magnetic lock

GLAZING

- TURAN 1 model, 4 mm tempered glass or, for an additional charge, frosted or black VSG441 laminated safety glass, smooth on both sides
- TURAN 7 model available with a mirror on one side. Other side - varnished board WHITE TITANIUM UV. Obverse - mirror on the hinge side.

MOULDING

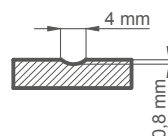

PAINTED

WHITE TITANIUM UV

EXTRA CHARGES

free of charge factory drilled through holes for the handles (split handles) ordered in the package with the leaf **NEW**

ventilation cut

"100" rebated and non-rebated door leaf

metal hinge casings in the rebated door leaf (brushed nickel, patina, polished chrome, polished brass, white or black)

frosted or black VSG 221 laminated safety glass, smooth on both sides (for TURAN 1)

drop-down gasket ¹⁾

can be replaced with a black magnetic lock for non-rebated door leaves

magnetic stop (buffer) ¹⁾ **NEW**
(available in six colours p. 132)

AVAILABLE SOLUTIONS (p. 135-143)

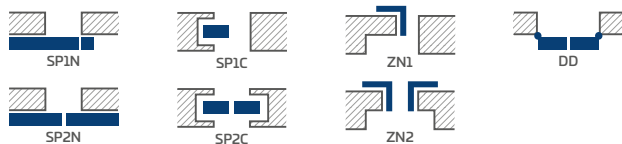

AVAILABLE DOOR LEAF WIDTHS

60 70 80 90 100

¹⁾ a stop prevents application of a drop-down gasket and vice versa



MILDA

produkt rekomendowany
do konkursu



2019

REBATED, NON-REBATED AND REVERSE PAINTED DOORS



MILDA 4, CUBE PREMIUM handle, black



MILDA 1



MILDA 2



MILDA 3



MILDA 4



MILDA 5

MILDA 2 with CUBE PREMIUM handle, black



CONSTRUCTION

- rebated, non-rebated or reverse door leaf
- internal timber stile (sides and top, bottom -MDF) covered with two HDF boards
- honeycomb stabilising filling or solid core filling for an additional charge
- optionally, upon extra charge, upper panels extending the frame – page 134

FINISHING

- door leaves and door frames coated with water-based UV hardened varnish for high resistance to adverse use conditions
- door leaf edge made in standard or non-rebated technology

HARDWARE

- three pin mortise hinges in a rebated door leaf
- three concealed hinges in the non-adjacent leaf and two hinges in the reverse leaf in silver (black for an extra charge); hinges are supplied and priced with the door frame
- a deadbolt lock in the rebated door leaf and a key-locked magnetic lock in the non-rebated and reverse door leaves, thumb turn cylinder, economy or silver with a blockade or, optionally, for an additional charge, a black magnetic lock

MOULDING

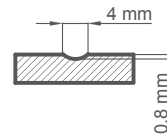

PAINTED



WHITE TITANIUM UV

AVAILABLE SOLUTIONS (p. 135-143)

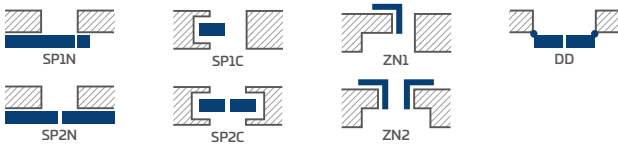

AVAILABLE DOOR LEAF WIDTHS



EXTRA CHARGES

reverse door leaf

solid core filling

ventilation cut

"100" rebated and non-rebated door leaf

additional bottom rail (can be cut by customer up to max 8 cm)

metal hinge casings in the rebated door leaf (brushed nickel, patina, polished chrome, polished brass, white or black)

drop-down gasket ¹⁾

can be replaced with a black magnetic lock for non-rebated and reverse leaves

magnetic stop (buffer) ¹⁾ **NEW**
(available in six colours p. 132)

¹⁾ a stop prevents application of a drop-down gasket and vice versa



SYLENA

REBATED, NON-REBATED AND REVERSE PAINTED DOORS



SYLENA 2, CUBE handle, black, matt



SYLENA 1



SYLENA 2



SYLENA 3



SYLENA 4



SYLENA 5



SYLENA 6



SYLENA 7



SYLENA 8

SYLENA 7 with CUBE handle, black, matt



CONSTRUCTION

- rebated, non-rebated or reverse door leaf
- internal timber stile (sides and top, bottom -MDF) covered with two HDF boards
- honeycomb stabilising filling or solid core filling for an additional charge
- optionally, upon extra charge, upper panels extending the frame – page 134

FINISHING

- door leaves and door frames coated with water-based UV hardened varnish for high resistance to adverse use conditions
- door leaf edge made in standard or non-rebated technology

HARDWARE

- three pin mortise hinges in a rebated door leaf
- three concealed hinges in the non-adjacent leaf and two hinges in the reverse leaf in silver (black for an extra charge); hinges are supplied and priced with the door frame
- a deadbolt lock in the rebated door leaf and a key-locked magnetic lock in the non-rebated and reverse door leaves, thumb turn cylinder, economy or silver with a blockade or, optionally, for an additional charge, a black magnetic lock

MOULDING

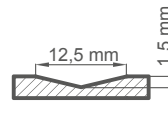

PAINTED



WHITE TITANIUM UV

AVAILABLE SOLUTIONS (p. 135-143)

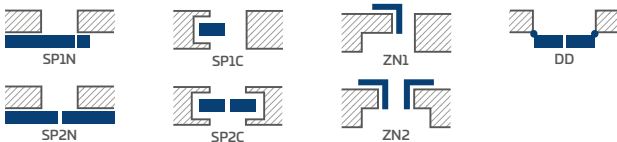

AVAILABLE DOOR LEAF WIDTHS

60 70 80 90 100

EXTRA CHARGES

reverse door leaf

solid core filling

ventilation cut

"100" rebated and non-rebated door leaf

additional bottom rail (can be cut by customer up to max 8 cm)

metal hinge casings in the rebated door leaf (brushed nickel, patina, polished chrome, polished brass, white or black)

drop-down gasket ¹⁾

can be replaced with a black magnetic lock for non-rebated and reverse leaves

magnetic stop (buffer) ¹⁾

NEW

(available in six colours p. 132)

¹⁾ a stop prevents application of a drop-down gasket and vice versa

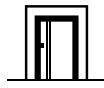

INLAYS

DECORATIVE INSERT FLUSH WITH THE LAMINATE SURFACE

LUX INLAY BLACK



inlay LUX 213



inlay LUX 212



inlay LUX 204



inlay LUX 216



inlay LUX 214



inlay LUX 207



inlay LUX 209

door frame: BLACK ST CPL door leaf: NATUR OAK PREMIUM



inlay LUX 203
door frame BLACK ST CPL
door leaf NATUR OAK PREMIUM
CUBE handle, black matt

LUX INLAY OAK



inlay LUX 313



inlay LUX 312



inlay LUX 304



inlay LUX 303



inlay LUX 316



inlay LUX 314



inlay LUX 307



inlay LUX 309

Door frame OAK CPL 0,2 leaf WHITE ST CPL



inlay LUX 315
door frame OAK CPL 0,2
door leaf WHITE ST CPL
TOPAZ INOX handle

INLAYS are located on both sides of the leaf and are flush with its surface.
The inlay width is 8 mm and 220 mm (LUX 315 inlay).

Available colours of the LUX INLAY:
brushed steel, black, brushed gold, oak (compatible with OAK CPL 0.2 and 0.7).

The presented INLAYS can be optionally used in the following models for an additional charge:

- UNO PREMIUM laminate
- ALTAMURA 1
- FORTECA RC2 & RC3
- HERSE SET 32 dB
- HERSE SET AKUSTIC 39 dB
- LEDA EI30, EI60
- HYPERION EI30 RC2

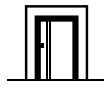

INLAYS

DECORATIVE INSERT FLUSH WITH THE LAMINATE SURFACE

LUX INLAY BRUSHED GOLD NEW



inlay LUX 412



inlay LUX 404



inlay LUX 403



inlay LUX 416



inlay LUX 414



inlay LUX 407



inlay LUX 409

Door frame and leaf BLACK ST CPL



inlay LUX 413
door frame BLACK ST CPL
door leaf BLACK ST CPL
BELLA handle slim square brass satin

LUX INLAY BRUSHED STEEL



inlay LUX 113



inlay LUX 112



inlay LUX 104



inlay LUX 103



inlay LUX 116

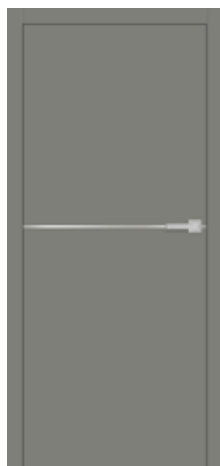

inlay LUX 114



inlay LUX 107
 door frame LIGHT-GREY ST CPL
 door leaf LIGHT GREY ST CPL
 TOPAZ INOX handle



inlay LUX 109

door frame and leaf: LIGHT-GREY ST CPL

INLAYS are located on both sides of the leaf and are flush with its surface.
 The inlay width is 8 mm and 220 mm (LUX 315 inlay).

Available colours of the LUX INLAY:
 brushed steel, black, brushed gold, oak (compatible with OAK CPL 0.2 and 0.7).

The presented INLAYS can be optionally used in the following models for an additional charge:

- UNO PREMIUM laminate
- ALTAMURA 1
- FORTECA RC2 & RC3
- HERSE SET 32 dB
- HERSE SET AKUSTIC 39 dB
- LEDA EI30, EI60
- HYPERION EI30 RC2



BALDUR

REBATED, NON-REBATED AND REVERSE INTERIOR DOORS



BALDUR 1, leaf decor NATUR OAK PREMIUM HORIZONTAL, frame decor BLACK ST CPL, handle QUBIK black mat



BALDUR 1



BALDUR 3

BALDUR 1 non-rebated version, decor NATUR OAK PREMIUM HORIZONTAL, handle QUBIK, black matt



CONSTRUCTION

- rebated, non-rebated or reverse door leaf
- internal timber stile (sides and top, bottom -MDF) covered with two HDF boards
- honeycomb stabilising filling or solid core filling for an additional charge
- optionally, upon extra charge, upper panels extending the frame – page 134

FINISHING

- HDF board in PREMIUM or CPL laminate
- leaf edge made in the standard rebated or non-rebated technology with CPL 0.2 laminates, laminated with the ABS edging, and in the same colour as the leaf only or, for an additional charge, with a standard black edge
- reverse door leaf only in with the STANDARD edge and with the GREKO, PREMIUM and ST CPL decors
- the edge laminated in the same colour as the door leaf surface or, optionally, in plain black (NATUR OAK PREMIUM HORIZONTAL, black edge with a transverse structure) black, partial edge finish (two vertical and a top one) and by the glass.
- door-leaf BALDUR 1 rebated and non-rebated only for the WHITE ST CPL decor made optionally in the soft technology **NEW** (no visible longitudinal laminate joints), requiring the use of a solid core at an extra charge
- the BALDUR 1 sliding systems have a visible 17 mm high aluminium or black coloured profile in the lower part of the glass pane

HARDWARE

- three pin mortise hinges in a rebated door leaf
- three concealed hinges in the non-adjacent leaf and two hinges in the reverse leaf in silver (black for an extra charge); hinges are supplied and priced with the door frame
- a deadbolt lock in the rebated door leaf and a key-locked magnetic lock in the non-rebated and reverse door leaves, thumb turn cylinder, economy or silver with a blockade or, optionally, for an additional charge, a black magnetic lock

GLAZING

- BALDUR 1, 3: 8 mm tempered frosted glass or VSG/ESG 441 safety glass, frosted or black, smooth on both sides

AVAILABLE DOOR LEAF WIDTHS

60 70 80 90 100

EXTRA CHARGES

reverse door leaf **NEW**
(unavailable for CPL 0,2 and for BALDUR 1 with SOFT edge)

solid core filling

ventilation cut

"100" rebated and non-rebated door leaf

frosted or black VSG/ESG 441 glazing

metal hinge casings in the rebated door leaf (brushed nickel, patina, polished chrome, polished brass, white or black)

black door leaf edge finish

can be replaced with a black magnetic lock for non-rebated and reverse leaves

magnetic stop (buffer) **NEW**
(available in six colours p. 132)

VENTILATION CUT



¹⁾ plain white laminate imitating a painted surface

²⁾ special **AntiFinger** **NEW** coating to reduce dirt and fingerprints

³⁾ BALDUR 3 model not available in sliding systems or double-leaf doors

⁴⁾ only soft version for BALDUR 1 rebated and non-rebated with WHITE ST CPL decor and only available at an extra charge with solid core

⁵⁾ available as of 01/04/2022

CPL

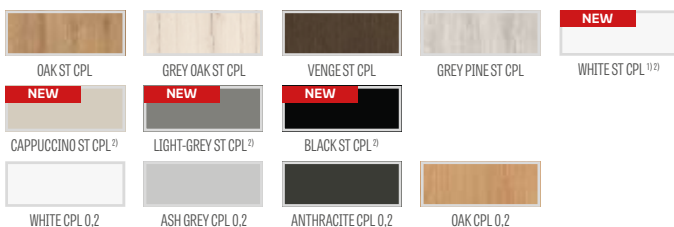

PREMIUM

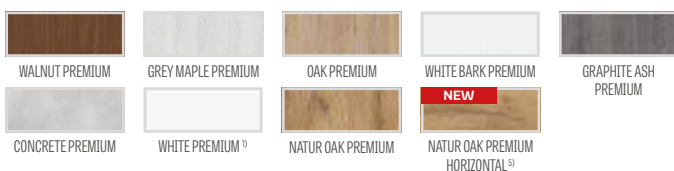

AVAILABLE SOLUTIONS³⁾ (p. 135-143)



EDGE FINISH TYPES

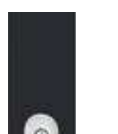
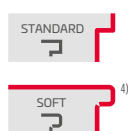

BLACK PLAIN DOOR LEAF EDGE FINISH



BLACK TRANSVERSE DOOR LEAF EDGE FINISH



BALDUR

REBATED, NON-REBATED AND REVERSE INTERIOR DOORS



BALDUR 3, decor CAPPUCCINO ST CPL, handle CUBE

BALDUR1 with LIGHT-GREY ST CPL laminate, door frame BLACK ST CPL, CUBE handle



BALDUR3 with WHITE ST CPL laminate, door frame BLACK ST CPL, CUBE handle





BALDUR 1, LIGHT-GREY ST CPL decor, TOPAZ INOX handle

BALDUR1 with CAPPUCINO ST CPL laminate and a TOPAZ INOX handle



BALDUR3 with NATUR OAK PREMIUM laminate and a TOPAZ INOX handle





UNO PREMIUM

REBATED, NON-REBATED AND REVERSE INTERIOR DOORS

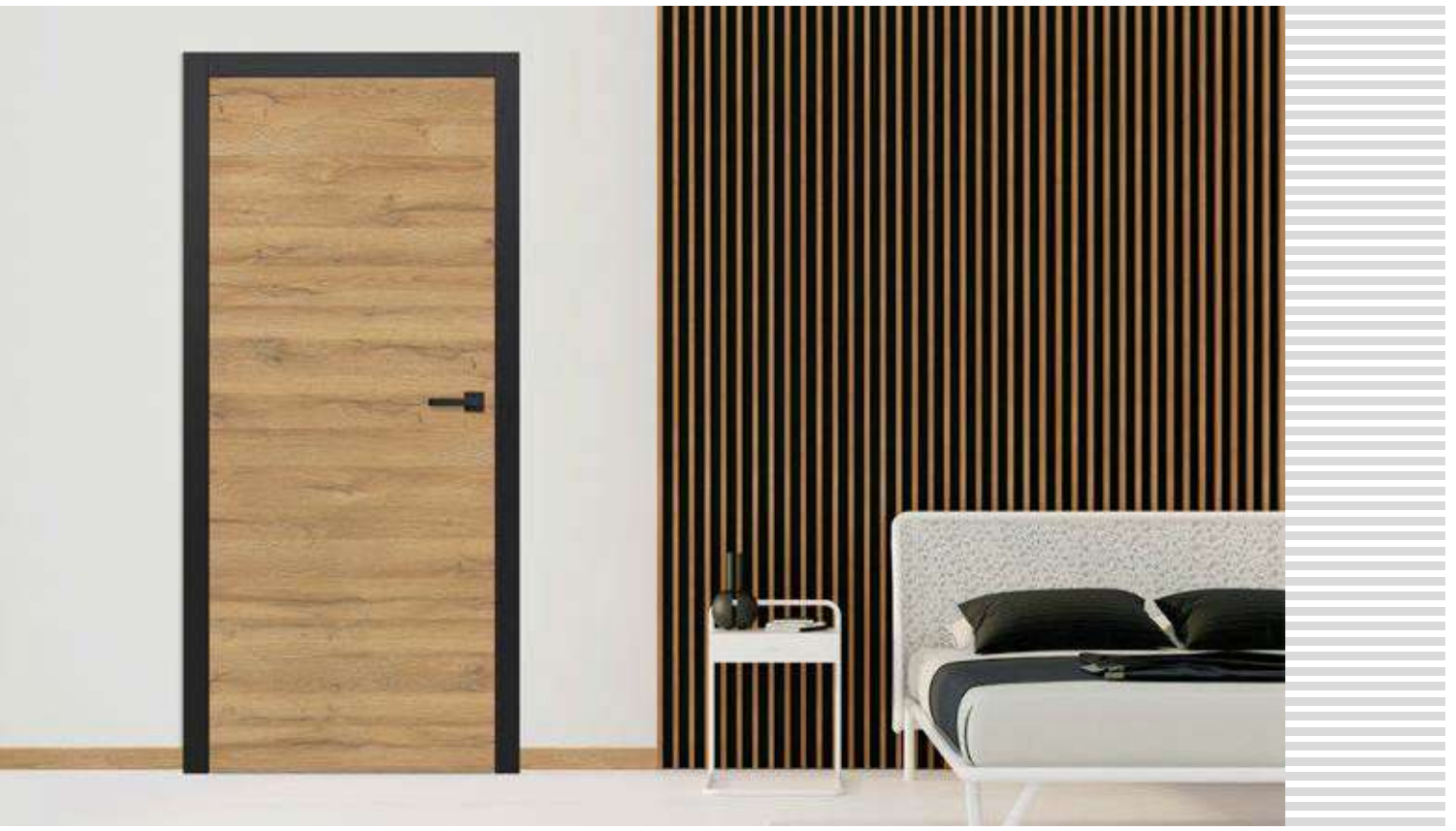

UNO PREMIUM, leaf decor transverse NATUR OAK PREMIUM, door frame BLACK ST CPL, handle CUBE slim black mat

UNO PREMIUM with transverse NATUR OAK PREMIUM laminate and a CUBE handle



UNO PREMIUM with transverse NATUR OAK PREMIUM, door, CUBE handle



UNO PREMIUM with WHITE PREMIUM laminate and a black mat BELLA PREMIUM handle

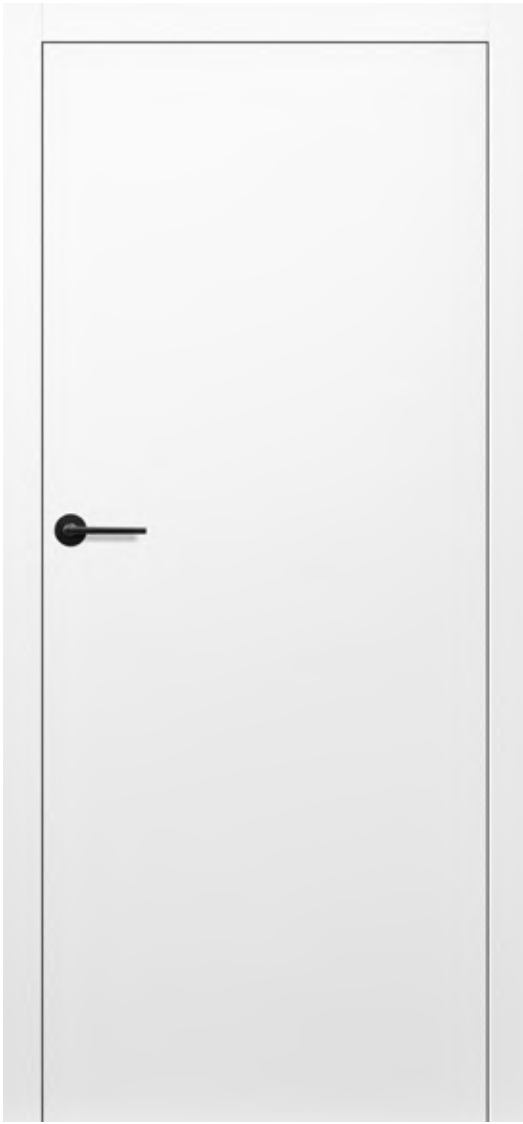

CONSTRUCTION

- rebated, non-rebated or reverse door leaf
- internal timber stile (sides and top, bottom -MDF) covered with two HDF boards
- stabilizing "honeycomb" filling
- solid core filling, for an additional charge
- optionally, upon extra charge, upper panels extending the frame – page 134

FINISHING

- HDF board with PREMIUM laminate
- door leaf edge made in standard rebated or non-rebated technology
- the edge laminated in the same colour as the door leaf surface or, optionally, in plain black (the decor options include NATUR OAK PREMIUM HORIZONTAL with a black edge with a horizontal structure)
- inserts (inlay) colour: brushed steel, black, brushed gold and OAK CPL with a width of 8 mm or 220 mm (LUX inlay315) flush with the leaf, on both sides of the leaf

HARDWARE

- three pin mortise hinges in a rebated door leaf
- three concealed hinges in the non-adjacent leaf and two hinges in the reverse leaf in silver (black for an extra charge); hinges are supplied and priced with the door frame
- bolt lock in the rebate leaf and a magnetic lock in the non-rebate and reverse leaf: with a key, thumb turn cylinder, economy or with silver, with a blockage; optionally, for an extra charge, a black magnetic lock

AVAILABLE SOLUTIONS (p. 135-143)

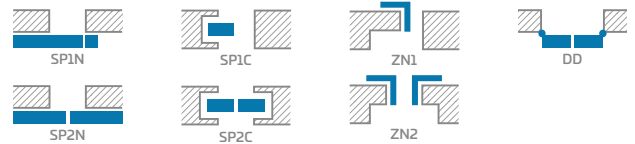

EXTRA CHARGES

reverse door leaf

solid core filling

door closer reinforcement

arm door closer (silver, black, white, brown)

additional bottom bar (can be cut by customer up to max 8 cm)

round and square metal sleeves (4 pcs);

brushed nickel or patina finish, white and black

plastic woodgrain sleeves (4 pcs)

ventilation door cut or grille

"100" rebated and non-rebated door leaf

"110" rebated and non-rebated door leaf

drop-down gasket ²⁾

metal hinge casings in the rebated door leaf (brushed nickel, patina, polished chrome, polished brass, white or black)

stainless steel porthole: "chrome" polished or "satine" brushed; frosted decormat glass, clear glass; porthole ID 235 mm external 350 mm)

black door leaf edge finish

can be replaced with a black magnetic lock for non-rebated and reverse leaves

magnetic stop (buffer) ²⁾ **NEW**
(available in six colours p. 132)

LUX inlay; available versions p. 80-81

PREMIUM

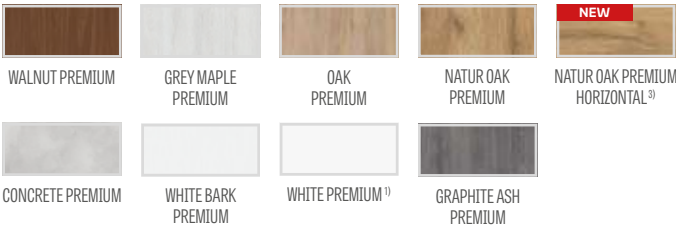

AVAILABLE DOOR LEAF WIDTHS

60 70 80 90 100 110

EDGE FINISH TYPES



¹⁾ plain white laminate imitating a painted surface

²⁾ a stop prevents application of a drop-down gasket and vice versa

³⁾ available as of 01/04/2022



ALTAMURA

REBATED, NON-REBATED AND REVERSE INTERIOR DOORS



ALTAMURA 5, decor: OAK ST CPL, LINEA handle



ALTAMURA 1



ALTAMURA 2



ALTAMURA 3



ALTAMURA 4



middle panel



grille panel



ALTAMURA 5



ALTAMURA 6



ALTAMURA 7



ALTAMURA 8



bottom panel

CONSTRUCTION

- rebated, non-rebated or reverse door leaf
- MDF stiles and rails covered with two HDF boards in GREKO and FINISH laminates
- internal timber stile (sides and top, bottom -MDF) covered with two HDF boards in CPL and PREMIUM decor
- honeycomb stabilising filling or solid core filling for an additional charge
- optionally, upon extra charge, upper panels extending the frame – page 134

FINISHING

- laminated HDF board
- door leaf edge made in the SOFT (FINISH & GREKO) or the STANDARD (FINISH, GREKO, PREMIUM & CPL) technology
- CPL 0.2 & 0.7 laminates available only with the STANDARD edge with the ABS edging in the same colour as the door leaf only or, for an additional charge, with a standard black edge
- reverse door leaf only in the STANDARD edge and in GREKO, PREMIUM and ST CPL decors
- edge (in standard or non-rebated finish) laminated in edging in the same colour as the surface or, optionally, in plain black (black edging with NATUR OAK PREMIUM HORIZONTAL, a black edge with a transverse structure)
- for ALTAMURA 1 double-sided inlays available for an additional charge, as shown on pages 78-81

HARDWARE

- three pin mortise hinges in a rebated door leaf
- three concealed hinges in the non-adjacent leaf and two hinges in the reverse leaf in silver (black for an extra charge); hinges are supplied and priced with the door frame
- a deadbolt lock in the rebated door leaf and a key-locked magnetic lock in the non-rebated and reverse door leaves, thumb turn cylinder, economy or silver with a blockade or, optionally, for an additional charge, a black magnetic lock

GLAZING

- frosted Decormat glass as standard, transparent or, charged extra, frosted VSG 221 safety glass, smooth on both sides
- possibility to change the glazing side to REVERSE (OBSERVE - standard glazing)

EXTRA CHARGES

reverse door leaf (unavailable for CPL 0,2 and 0,7)

solid core filling (price includes a third hinge used in the rebated door leaf as standard)

door closer reinforcement

arm door closer (silver, black, white, brown)

additional bottom bar (can be cut by customer up to max 8 cm)

ventilation door cut or grille

metal round or square ventilation sleeves (4 pcs);
brushed nickel or patina finish in white or black

plastic sleeves

"100" rebated and non-rebated door leaf

"110" rebated and non-rebated door leaf

solid core filling (price includes a third hinge used in the rebated door leaf as standard)

frosted VSG 221 laminated glass

drop-down gasket³⁾

metal hinge casings in the rebated door leaf (brushed nickel, patina, polished chrome, polished brass, white or black)

ALTAMURA 1: stainless steel porthole: polished "chrome" or brushed "satin" and black matt; frosted decormat glass, clear glass; portholediameter: internal: 235 mm; external 350 mm)

stainless steel panel (fitted on both sides in the rebated STANDARD door leaves only), height 300mm

black door leaf edge finish

can be replaced with a black magnetic lock for non-rebated and reverse leaves

magnetic stop (buffer)³⁾ **NEW**
(available in six colours p. 132)

ALTAMURA 1 model: LUX inlay; available versions p. 80-81

FINISH



LIGHT ACACIA FINISH

GREKO

GREKO WALNUT

SANREMO GREKO

GREKO SONOMA

MEDIUM GREKO OAK

GREKO ELM

GOLDEN GREKO OAK

GREKO GREY OAK

GREKO WHITE PINE

WHITE GREKO¹⁾²⁾

SNOW-WHITE GREKO¹⁾²⁾

GREKO OAK

CPL

OAK ST CPL

GREY OAK ST CPL

VENGE ST CPL

GREY PINE ST CPL

NEW WHITE ST CPL¹⁾⁴⁾

NEW CAPPUCCINO ST CPL⁴⁾

NEW LIGHT-GREY ST CPL⁴⁾

NEW BLACK ST CPL⁴⁾

WHITE CPL 0.2 & 0.7

ASH GREY CPL 0.2 & 0.7

ANTHRACITE CPL 0.2 & 0.7

OAK CPL 0.2 & 0.7

PREMIUM

WALNUT PREMIUM

GREY MAPLE PREMIUM

OAK PREMIUM

WHITE BARK PREMIUM

GRAPHITE ASH PREMIUM

CONCRETE PREMIUM

WHITE PREMIUM¹⁾

NATUR OAK PREMIUM

NEW NATUR OAK PREMIUM HORIZONTAL³⁾

AVAILABLE DOOR LEAF WIDTHS

60 70 80 90 100 110

GLASS FRAME

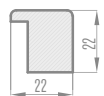

AVAILABLE SOLUTIONS (p. 135-143)

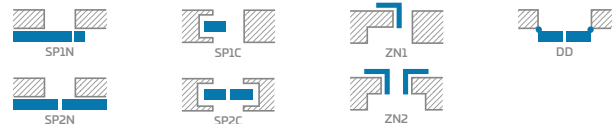

EDGE FINISH TYPES

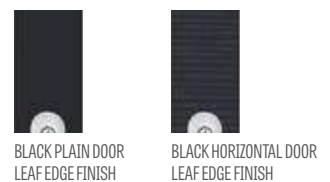
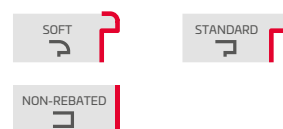

¹⁾ plain white laminate imitating a painted surface

²⁾ available only in STANDARD

³⁾ a stop prevents application of a drop-down gasket and vice versa

⁴⁾ special **AntiFinger** coating **NEW** to reduce dirt and fingerprints

⁵⁾ available as of 01/04/2022



ANSEDONIA

REBATED, NON-REBATED AND REVERSE INTERIOR DOORS



GREY OAK ST CPL Finish, TOPAZ INOX handle



ANSEDONIA 1



ANSEDONIA 2



ANSEDONIA 3



ANSEDONIA 4



ANSEDONIA 5



ANSEDONIA 6



ANSEDONIA 7



ANSEDONIA 8



ANSEDONIA 9



ANSEDONIA 10



ANSEDONIA 11



ANSEDONIA 12

CONSTRUCTION

- rebated, non-rebated or reverse door leaf
- MDF stiles and rails covered with two HDF boards in GREKO and FINISH laminates
- internal timber stile (sides and top, bottom -MDF) covered with two HDF boards in CPL and PREMIUM decor
- honeycomb stabilising filling or solid core filling for an additional charge
- optionally, upon extra charge, upper panels extending the frame – page 134

FINISHING

- laminated HDF board
- door leaf edge made in the SOFT or STANDARD technology.
- CPL 0.2 & 0.7 laminates available only with the STANDARD edge with the ABS edging in the same colour as the door leaf only or, for an additional charge, with a standard black edge
- reverse door leaf only in the STANDARD edge and in GREKO, PREMIUM and ST CPL decors
- edge (in standard or non-rebated finish) laminated in edging in the same colour as the surface or, optionally, in plain black (black edging with NATUR OAK PREMIUM HORIZONTAL, a black edge with a transverse structure)

HARDWARE

- three pin mortise hinges in a rebated door leaf
- three concealed hinges in the non-adjacent leaf and two hinges in the reverse leaf in silver (black for an extra charge); hinges are supplied and priced with the door frame
- bolt lock in the rebated leaf and a key-locked magnetic lock in the non-rebated and reverse door leaves, thumb turn cylinder, economy or silver with a blockade or, optionally, for an additional charge, a black magnetic lock

GLAZING

- **frosted Decormat glass as standard**, transparent or, charged extra, frosted VSG 221 safety glass, smooth on both sides
- possibility to change the glazing side to REVERSE (OBSERVE - standard glazing)

EXTRA CHARGES

reverse door leaf

(not available in CPL 0.2 & 0.7)

solid core filling (price includes a third hinge used in the rebated door leaf as standard)

door closer reinforcement

arm door closer (silver, black, white, brown)

additional bottom bar (can be cut by customer up to max 8 cm)

ventilation door cut or grille

plastic sleeves

metal round or square ventilation sleeves (4 pcs);

brushed nickel or patina finish in white or black

"100" rebated and non-rebated door leaf (price includes a third hinge used in the door leaf as standard)

frosted VSG 221 laminated glass, smooth on both sides

drop-down gasket³⁾

metal hinge casings in the rebated door leaf (brushed nickel, patina, polished chrome, polished brass, white or black)

black door leaf edge finish

can be replaced with a black magnetic lock for non-rebated and reverse leaves

magnetic stop (buffer)³⁾ **NEW**

(available in six colours p. 132)

FINISH



LIGHT ACACIA FINISH

GREKO



GREKO WALNUT



SANREMO GREKO



GREKO SONOMA



MEDIUM GREKO OAK



GREKO ELM



GOLDEN GREKO OAK



GREKO GREY OAK



GREKO WHITE PINE

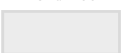

WHITE GREKO¹⁾²⁾



SNOW-WHITE GREKO¹⁾²⁾



GREKO OAK

CPL



OAK ST CPL



GREY OAK ST CPL



VENGE ST CPL



GREY PINE ST CPL



WHITE ST CPL¹⁾⁴⁾



CAPPUCCINO ST CPL⁴⁾



LIGHT-GREY ST CPL⁴⁾



BLACK ST CPL⁴⁾

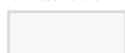

WHITE CPL 0.2 & 0.7



ASH GREY CPL 0.2 & 0.7

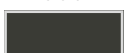

ANTHRACITE CPL 0.2 & 0.7



OAK CPL 0.2 & 0.7

PREMIUM



WALNUT PREMIUM



GREY MAPLE PREMIUM



OAK PREMIUM

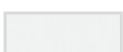

WHITE BARK PREMIUM



GRAPHITE ASH PREMIUM



CONCRETE PREMIUM

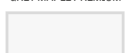

WHITE PREMIUM¹⁾



NATUR OAK PREMIUM



NATUR OAK PREMIUM HORIZONTAL⁵⁾

AVAILABLE DOOR LEAF WIDTHS

60 70 80 90 100

GLASS FRAME



AVAILABLE SOLUTIONS (p. 135-143)

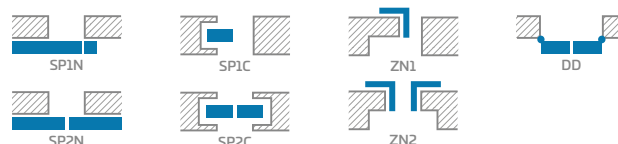

EDGE FINISH TYPES

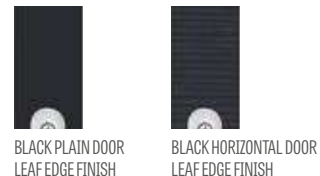
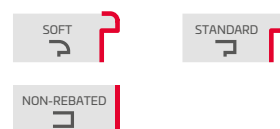

¹⁾ plain white laminate imitating a painted surface

²⁾ available only in STANDARD

³⁾ a stop prevents application of a drop-down gasket and vice versa

⁴⁾ special **AntiFinger** coating **NEW** to reduce dirt and fingerprints

⁵⁾ available as of 01/04/2022



LORIENT

REBATED, NON-REBATED AND REVERSE INTERIOR DOORS



LORIENT 1, GREY MAPLE PREMIUM decor, TOPAZ INOX handle



LORIENT 1



LORIENT 2



LORIENT 3



LORIENT 4



LORIENT 5



LORIENT 6



LORIENT 7



LORIENT 8



LORIENT 9



LORIENT 10



LORIENT 11



LORIENT 12

CONSTRUCTION

- rebated, non-rebated or reverse door leaf
- MDF stiles and rails covered with two HDF boards in GREKO and FINISH laminates
- internal timber stile (sides and top, bottom -MDF) covered with two HDF boards in CPL and PREMIUM decor
- honeycomb stabilising filling or solid core filling for an additional charge
- optionally, upon extra charge, upper panels extending the frame – page 134

FINISHING

- laminated HDF board
- door leaf edge made in the SOFT or STANDARD technology.
- reverse door leaf only in the STANDARD edge and in GREKO, PREMIUM and ST CPL decors
- edge (in standard or non-rebated finish) laminated in edging in the same colour as the surface or, optionally, in plain black (black edging with NATUR OAK PREMIUM HORIZONTAL, a black edge with a transverse structure)

HARDWARE

- three pin mortise hinges in a rebated door leaf
- three concealed hinges in the non-adjacent leaf and two hinges in the reverse leaf in silver (black for an extra charge); hinges are supplied and priced with the door frame
- bolt lock in the rebated leaf and a key-locked magnetic lock in the non-rebated and reverse door leaves, thumb turn cylinder, economy or silver with a blockade or, optionally, for an additional charge, a black magnetic lock

GLAZING

- **frosted Decormat glass as standard**, transparent or, charged extra, frosted VSG 221 safety glass, smooth on both sides
- possibility to change the glazing side to REVERSE (OBSERVE - standard glazing)

EXTRA CHARGES

reverse door leaf

solid core filling (price includes a third hinge used in the rebated door leaf as standard)

door closer reinforcement

arm door closer (silver, black, white, brown)

additional bottom bar (can be cut by customer up to max 8 cm)

ventilation door cut or grille

plastic sleeves

metal round or square ventilation sleeves (4 pcs);
brushed nickel or patina finish in white or black

"100" rebated and non-rebated door leaf (price includes a third hinge used in the door leaf as standard)

frosted VSG 221 laminated glass, smooth on both sides

drop-down gasket ³⁾

metal hinge casings in the rebated door leaf (brushed nickel, patina, polished chrome, polished brass, white or black)

black door leaf edge finish

can be replaced with a black magnetic lock for non-rebated and reverse leaves

magnetic stop (buffer) ³⁾ **NEW**
(available in six colours p. 132)

FINISH



LIGHT ACACIA FINISH

GREKO



GREKO WALNUT

SANREMO GREKO

GREKO SONOMA

MEDIUM GREKO OAK

GREKO ELM



GOLDEN GREKO OAK

GREKO GREY OAK

GREKO WHITE PINE

WHITE GREKO ¹⁾

SNOW-WHITE GREKO ¹⁾



GREKO OAK

CPL



OAK ST CPL

GREY OAK ST CPL

VENGE ST CPL

GREY PINE ST CPL

WHITE ST CPL ¹⁾



CAPPUCCINO ST CPL ⁴⁾

LIGHT-GREY ST CPL ⁴⁾

BLACK ST CPL ⁴⁾

PREMIUM



WALNUT PREMIUM

GREY MAPLE PREMIUM

OAK PREMIUM

WHITE BARK PREMIUM

GRAPHITE ASH PREMIUM



CONCRETE PREMIUM

WHITE PREMIUM ¹⁾

NATUR OAK PREMIUM

NATUR OAK PREMIUM HORIZONTAL ⁵⁾

AVAILABLE DOOR LEAF WIDTHS

60 70 80 90 100

GLASS FRAME



AVAILABLE SOLUTIONS (p. 135-143)

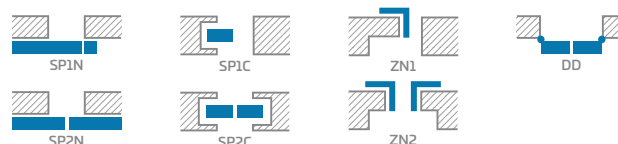

EDGE FINISH TYPES

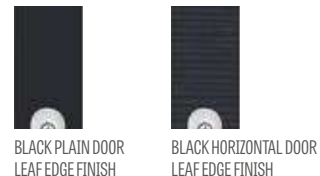
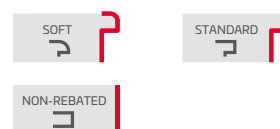

¹⁾ plain white laminate imitating a painted surface

²⁾ available only in STANDARD

³⁾ a stop prevents application of a drop-down gasket and vice versa

⁴⁾ special **AntiFinger** coating **NEW** to reduce dirt and fingerprints

⁵⁾ available as of 01/04/2022



MENTON

REBATED, NON-REBATED AND REVERSE INTERIOR DOORS



MENTON 1; GREY GREKO OAK decor, black matt TOPAZ



MENTON 1



MENTON 2



MENTON 3



MENTON 4



MENTON 5



MENTON 6



MENTON 7



MENTON 8



MENTON 9



MENTON 10



MENTON 11



MENTON 12

CONSTRUCTION

- rebated, non-rebated or reverse door leaf
- MDF stiles and rails covered with two HDF boards in GREKO and FINISH laminates
- internal timber stile (sides and top, bottom -MDF) covered with two HDF boards in CPL and PREMIUM decor
- honeycomb stabilising filling or solid core filling for an additional charge
- optionally, upon extra charge, upper panels extending the frame – page 134

FINISHING

- door leaf edge made in the SOFT or STANDARD technology.
- CPL 0.2 & 0.7 laminates available only with the STANDARD edge with the ABS edging in the same colour as the door leaf only or, for an additional charge, with a standard black edge
- reverse door leaf only in the STANDARD edge and in GREKO, PREMIUM and ST CPL decors
- edge (in standard or non-rebated finish) laminated in edging in the same colour as the surface or, optionally, in plain black (black edging with NATUR OAK PREMIUM HORIZONTAL, a black edge with a transverse structure)

HARDWARE

- three pin mortise hinges in a rebated door leaf
- three concealed hinges in the non-adjacent leaf and two hinges in the reverse leaf in silver (black for an extra charge); hinges are supplied and priced with the door frame
- bolt lock in the rebated leaf and a key-locked magnetic lock in the non-rebated and reverse door leaves, thumb turn cylinder, economy or silver with a blockade or, optionally, for an additional charge, a black magnetic lock

GLAZING

- **frosted Decormat glass as standard**, transparent or, charged extra, frosted VSG 221 safety glass, smooth on both sides
- possibility to change the glazing side to REVERSE (OBSERVE - standard glazing)

EXTRA CHARGES

reverse door leaf

(not available in CPL 0.2 & 0.7)

solid core filling (price includes a third hinge used in the rebated door leaf as standard)

door closer reinforcement

arm door closer (silver, black, white, brown)

additional bottom bar (can be cut by customer up to max 8 cm)

ventilation door cut or grille

metal round or square ventilation sleeves (4 pcs);
brushed nickel or patina finish in white or black

plastic sleeves

"100" rebated and non-rebated door leaf (price includes a third hinge used in the door leaf as standard)

frosted VSG 221 laminated glass

drop-down gasket ³⁾

metal hinge casings in the rebated door leaf (brushed nickel, patina, polished chrome, polished brass, white or black)

black door leaf edge finish

can be replaced with a black magnetic lock for non-rebated and reverse leaves

magnetic stop (buffer) ³⁾ **NEW**
(available in six colours p. 132)

FINISH



LIGHT ACACIA FINISH

GREKO



GREKO WALNUT



SANREMO GREKO



GREKO SONOMA



MEDIUM GREKO OAK



GREKO ELM



GOLDEN GREKO OAK



GREKO GREY OAK



GREKO WHITE PINE



WHITE GREKO ¹⁾²⁾



SNOW-WHITE GREKO ¹⁾²⁾



GREKO OAK

CPL



OAK ST CPL



GREY OAK ST CPL



VENGE ST CPL



GREY PINE ST CPL



WHITE ST CPL ¹⁾⁴⁾



CAPPUCCINO ST CPL ⁴⁾



LIGHT-GREY ST CPL ⁴⁾



BLACK ST CPL ⁴⁾

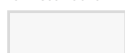

WHITE CPL 0.2 & 0.7



ASH GREY CPL 0.2 & 0.7

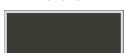

ANTHRACITE CPL 0.2 & 0.7



OAK CPL 0.2 & 0.7

PREMIUM



WALNUT PREMIUM



GREY MAPLE PREMIUM



OAK PREMIUM

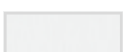

WHITE BARK PREMIUM



GRAPHITE ASH PREMIUM



CONCRETE PREMIUM

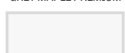

WHITE PREMIUM ¹⁾



NATUR OAK PREMIUM



NATUR OAK PREMIUM HORIZONTAL ⁵⁾

AVAILABLE DOOR LEAF WIDTHS

60 70 80 90 100

GLASS FRAME



AVAILABLE SOLUTIONS (p. 135-143)

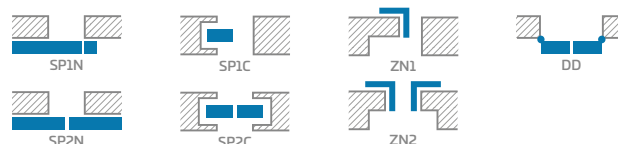

EDGE FINISH TYPES

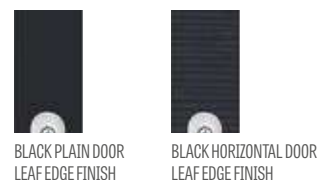
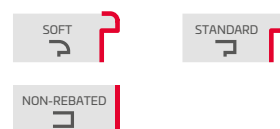

¹⁾ plain white laminate imitating a painted surface

²⁾ available only in STANDARD

³⁾ a stop prevents application of a drop-down gasket and vice versa

⁴⁾ special AntiFinger coating **NEW** to reduce dirt and fingerprints

⁵⁾ available as of 01/04/2022



SORANO

REBATED, NON-REBATED AND REVERSE INTERIOR DOORS



SORANO 1, decor: WENGE ST CPL, TOPAZ INOX handle



SORANO 1



SORANO 2



SORANO 3



SORANO 4



SORANO 5



SORANO 6



SORANO 7



SORANO 8



SORANO 9



SORANO 10



SORANO 11



SORANO 12

CONSTRUCTION

- rebated, non-rebated or reverse door leaf
- MDF stiles and rails covered with two HDF boards in GREKO and FINISH laminates
- internal timber stile (sides and top, bottom -MDF) covered with two HDF boards in the CPL and PREMIUM decor
- honeycomb stabilising filling or solid core filling for an additional charge
- optionally, upon extra charge, upper panels extending the frame – page 134

FINISHING

- door leaf edge made in the SOFT or STANDARD technology.
- CPL 0.2 & 0.7 laminates available only with the STANDARD edge with the ABS edging in the same colour as the door leaf only or, for an additional charge, with a standard black edge
- reverse door leaf only in the STANDARD edge and in GREKO, PREMIUM and ST CPL decors
- edge (in standard or non-rebated finish) laminated in edging in the same colour as the surface or, optionally, in plain black (black edging with NATUR OAK PREMIUM HORIZONTAL, a black edge with a transverse structure)

HARDWARE

- three pin mortise hinges in a rebated door leaf
- three concealed hinges in the non-adjacent leaf and two hinges in the reverse leaf in silver (black for an extra charge); hinges are supplied and priced with the door frame
- bolt lock in the rebated leaf and a key-locked magnetic lock in the non-rebated and reverse door leaves, thumb turn cylinder, economy or silver with a blockade or, optionally, for an additional charge, a black magnetic lock

GLAZING

- **frosted Decormat glass as standard**, transparent or, charged extra, frosted VSG 221 safety glass, smooth on both sides
- possibility to change the glazing side to REVERSE (OBSERVE - standard glazing)

EXTRA CHARGES

reverse door leaf

(not available in CPL 0.2 & 0.7)

solid core filling (price includes a third hinge used in the rebated door leaf as standard)

door closer reinforcement

arm door closer (silver, black, white, brown)

additional bottom bar (can be cut by customer up to max 8 cm)

ventilation door cut or grille

metal round or square ventilation sleeves (4 pcs);
brushed nickel or patina finish in white or black

plastic sleeves

"100" rebated and non-rebated door leaf (price includes a third hinge used in the door leaf as standard)

frosted VSG 221 laminated glass

drop-down gasket ³⁾

metal hinge casings in the rebated door leaf (brushed nickel, patina, polished chrome, polished brass, white or black)

black door leaf edge finish

can be replaced with a black magnetic lock for non-rebated and reverse leaves

magnetic stop (buffer) ³⁾ **NEW**
(available in six colours p. 132)

FINISH



LIGHT ACACIA FINISH

GREKO



GREKO WALNUT

SANREMO GREKO

GREKO SONOMA

MEDIUM GREKO OAK

GREKO ELM



GOLDEN GREKO OAK

GREKO GREY OAK

GREKO WHITE PINE

WHITE GREKO ¹⁾

SNOW-WHITE GREKO ¹⁾



GREKO OAK

CPL



OAK ST CPL

GREY OAK ST CPL

VENGE ST CPL

GREY PINE ST CPL

WHITE ST CPL ¹⁾



CAPPUCCINO ST CPL ⁴⁾

LIGHT-GREY ST CPL ⁴⁾

BLACK ST CPL ⁴⁾



WHITE CPL 0.2 & 0.7

ASH GREY CPL 0.2 & 0.7

ANTHRACITE CPL 0.2 & 0.7

OAK CPL 0.2 & 0.7

PREMIUM



WALNUT PREMIUM

GREY MAPLE PREMIUM

OAK PREMIUM

WHITE BARK PREMIUM

GRAPHITE ASH PREMIUM



CONCRETE PREMIUM

WHITE PREMIUM ¹⁾

NATUR OAK PREMIUM

NATUR OAK PREMIUM HORIZONTAL ⁵⁾

AVAILABLE DOOR LEAF WIDTHS

60 70 80 90 100

GLASS FRAME



AVAILABLE SOLUTIONS (p. 135-143)

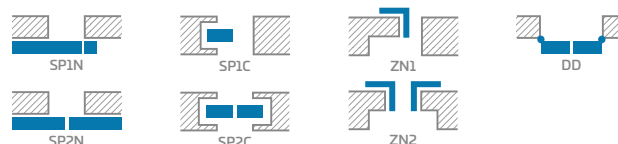

EDGE FINISH TYPES

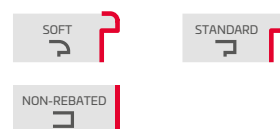

¹⁾ plain white laminate imitating a painted surface

²⁾ available only in STANDARD

³⁾ a stop prevents application of a drop-down gasket and vice versa

⁴⁾ special **AntiFinger** coating **NEW** to reduce dirt and fingerprints

⁵⁾ available as of 01/04/2022



FORTECA RC2 & RC3

OPENING INWARDS/OUTWARDS RC2 & RC3 BURGLARPROOF REBATED DOORS



FORTECA RC 3, decor: GRAPHITE ASH PREMIUM



2 HOOK BOLTS



UPPER AND LOWER SECURITY LOCKS



FOUR ADJUSTABLE DOOR STRIKER PLATES

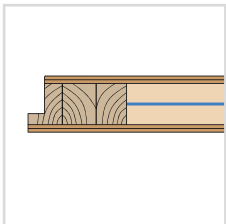

DOOR LEAF 46 mm reinforced with steel sheet



FORTECA RC2



FORTECA RC3



DOOR VIEWER



FOUR 2-PIN HINGES; Ø16, 3D ADJUSTABLE



4 HINGE BOLTS



FIXED TIMBER in RC2 or reinforced frame in RC3



HARDWOOD THRESHOLD (lacquer)



STAINLESS STEEL THRESHOLD



MULTIPOINT LOCK



FORTECA DOOR LEAF CROSS-SECTION

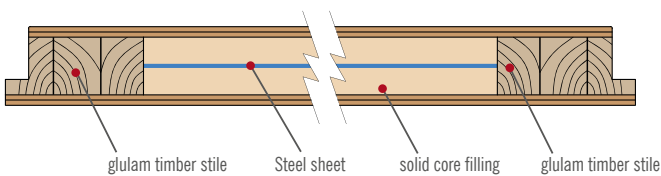

HARDWOOD THRESHOLD

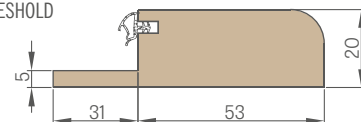

STAINLESS STEEL SHEET THRESHOLD

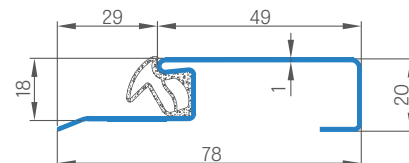



FORTECA RC2 & RC3

OPENING INWARDS/OUTWARDS RC2 & RC3 BURGLARPROOF REBATED DOORS



FORTECA RC2 & RC3 with OAK ST CPL laminate



FORTECA RC2, decor NATUR OAK PREMIUM, anti-burglar RC2 handle, black matt

FORTECA RC 2		
GOLD PACKAGE	SILVER PACKAGE	DOOR LEAF

RC2 – Important:
 For compliance with RC2 burglary resistance class as per the PN-EN 1627:2012, the hardware should meet the following requirements:

- Min Class 2 as per PN-EN 1906:2012 – for handles and door face plates
- Min Class 4 and 1 as per PN-EN 1303:2015 – for lock cylinders

FORTECA RC 3		
GOLD PACKAGE	SILVER PACKAGE	DOOR LEAF

RC3 – Important:
 For compliance with RC3 burglary resistance class as per PN-EN 1627:2012, the hardware should meet the following requirements:

- Min Class 3 as per PN-EN 1906:2012 – for handles and door face plates
- Min Class 4 and 1 as per PN-EN 1303:2015 – for lock cylinders

GENERAL INFORMATION

- FORTECA inwards/outwards opening burglar-proof doors are rated for sound insulation at $R_w=38$ Db, have a burglary resistance class of RC2 OR RC3 as per PN EN 1627:2012 and class 5 for mechanical durability.
- available in the GOLD and SILVER packages with optional installation kit and steel door frame.
- designed to be used as an internal front door.

CONSTRUCTION

- timber stile covered with glulam HDF boards
- specially designed solid core filling
- whole door leaf reinforced with a steel panel
- door leaf thickness of 46 mm

FINISHING

- leaf edge made in the STANDARD technology (with CPL 0.2 & 0.7 laminates, with the ABS edging in the same colour as the leaf only or with a standard black edge for an additional charge)
- 8 mm or 220 mm wide black brushed steel, brushed gold or OAK CPL inserts (inlays) flush with the door leaf, on both sides of the leaf
- the edge laminated in the same colour as the door leaf or, optionally plain black (NATUR OAK PREMIUM HORIZONTAL, black edge with a transverse structure)
- HDF board covered with the FINISH, GREKO or PREMIUM laminate
- side and top panels glued to the wall (only with a masonry wall installed door frame and an 8 cm clip-on square) made to order for additional charge - page 134

HARDWARE

- four silver 2-pin hinges; $\varnothing 16$; 3D adjustable (2D with steel frame)
- four-point security hook bolt lock as standard for two lock cores
- four-hinge bolts on the hinge side
- possibility to apply an arm door closer
- lower lock PZ centre is 92 mm

FIXED REBATED DOOR FRAME

- fixed timber door frame covered with MDF boards; Internally reinforced with a steel square on the door striker plates side for FORTECA RC3
- installation in the range of 90-450 mm every 40 mm
- adjustable main grip in the door frame and two adjustable grips for the bolt hook and additional lock

GOLD PACKAGE

- the GOLD PACKAGE FORTECA doors are complete with a steel or timber threshold, with a multipoint lock, and pre-drilled holes for a security handle and upper face plate. They come with a door viewer (hole to be drilled by the customer) and certified security handles and lock cores.

SILVER PACKAGE

- the SILVER PACKAGE FORTECA doors are complete with a steel or timber threshold, and a multipoint lock. We recommend ordering a door viewer and certified hardware from the ERKADO range or ordering the same from an external supplier keeping in mind the important note on compliance with the anti-burglary requirements (p. 100).

AVAILABLE DOOR LEAF WIDTHS

80N 80 90E 100

- **GOLD PACKAGE**
door leaf with fixed timber door frame, stainless steel threshold and hardware
- **SILVER PACKAGE**
door leaf with fixed timber door frame, stainless steel threshold, w/o hardware

EXTRA CHARGE

"100" door

black door leaf edge finish

handle PZ centre of 92 mm with the top face plate for RC 2 doors, silver F9 or black (Class 2 as per the PN-EN 1906:2012 standard)

handle with lock core protection and the rosette plate for the RC3 door; F9 silver (Class 3 as per PN-EN 1906:2012)

two silver lock cores set (one with a thumbturn) in a master key system for RC2 and RC3 doors (Class 4 & 1 as per PN-EN 1303:2015)

door viewer (nickel or black)

















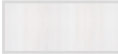
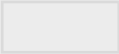





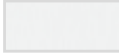





metal hinge casings: brushed nickel, patina, polished chrome, polished brass, white or black

cutting the door with the wooden frame to 8 cm and with steel frame to 1 cm

LUX inlay; available versions p. 80-81

arm door closer (silver, black, white, brown)

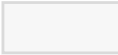
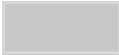
magnetic stop (buffer) **NEW**
(available in six colours p. 132)

GREKO				
				
GREKO WALNUT	SANREMO GREKO	GREKO SONOMA	MEDIUM GREKO OAK	GREKO ELM
				
GOLDEN GREKO OAK	GREKO GREY OAK	GREKO WHITE PINE	WHITE GREKO 1)	SNOW-WHITE GREKO 1)
				
GREKO OAK				
FINISH				
				
LIGHT ACACIA FINISH				
PREMIUM				
				
WALNUT PREMIUM	GREY MAPLE PREMIUM	OAK PREMIUM	WHITE BARK PREMIUM	GRAPHITE ASH PREMIUM
				
CONCRETE PREMIUM	WHITE PREMIUM 1)	NATUR OAK PREMIUM	NATUR OAK PREMIUM HORIZONTAL 3)	
CPL				
				
OAK ST CPL	GREY OAK ST CPL	VENGE ST CPL	GREY PINE ST CPL	WHITE ST CPL 1) 2)
				
CAPPUCINO ST CPL 1)	LIGHT-GREY ST CPL 1)	BLACK ST CPL 1)		
				
WHITE CPL 0.2 & 0.7	ASH GREY CPL 0.2 & 0.7	ANTHRACITE CPL 0.2 & 0.7	OAK CPL 0.2 & 0.7	

¹⁾ plain white laminate imitating a painted surface

²⁾ special **AntiFinger** **NEW** coating to reduce dirt and fingerprints

³⁾ available as of 01/04/2022



FIXED DOOR FRAME

FORTECA

FORTECA RC3 FIXED DOOR FRAME

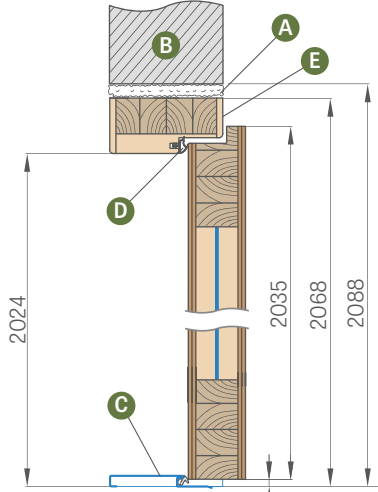

- A** - installation foam
- B** - wall
- C** - stainless steel or wooden threshold
- D** - rubber gasket
- E** - additional internal reinforcement in the frame with a steel square on the door striker plates side (only for the FORTECA RC3 door frame)

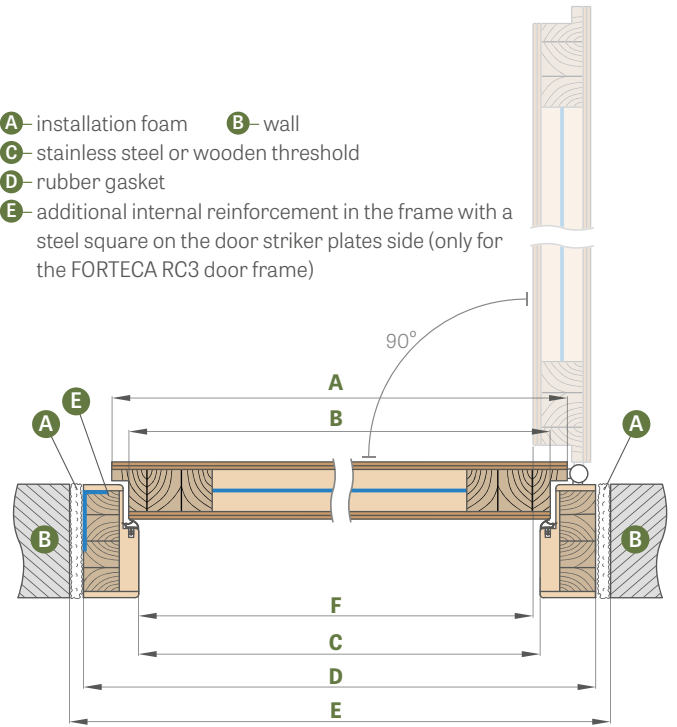

MASONRY WALL every 40 mm (the clip-on square not included, charged extra)

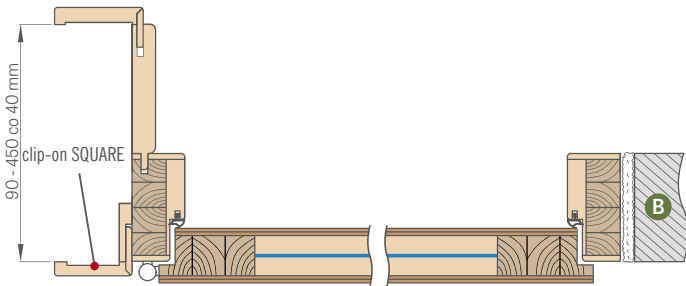

Door width	A	B	C	D	E	F
"80N"	804	778	764	852	892	759
"80"	848	822	808	896	936	803
„90E"	948	922	908	996	1036	903
"100"	1048	1022	1008	1096	1136	1003

„90E" - investment width

Range (mm)
90-130
130-170
170-210
210-250
250-290
290-330
330-370
370-410
410-450

FIXED DOOR FRAME

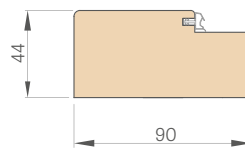

COVER PROFILE

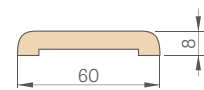

The wall cladding is available with a 6 cm or 8 cm internal angle and with a choice of 6 cm or 8 cm external angle for an extra charge.

EXTRA CHARGES

frame joints at 90 degrees

clip-on square with 60 mm or 80 mm clips (the clip-on square with three clips extends the adjustment range by 20 mm)

cutting the door with the steel frame to 8 cm in 1 cm increments

side and top panels glued to the wall available (only with a wall installed door frame and an 8 cm square)

headband and quarter round

SQUARE 6 cm and 8 cm with clips

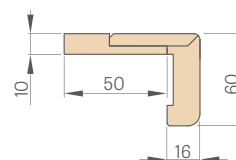
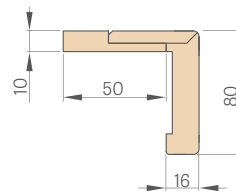

QUARTER ROUND

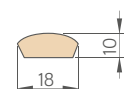



STEEL DOOR FRAMES

FORTECA

ADJUSTABLE STEEL DOOR FRAME

welded and coated in RAL 9010, 9016, 8003, 8017, 7016, 7047, 1001

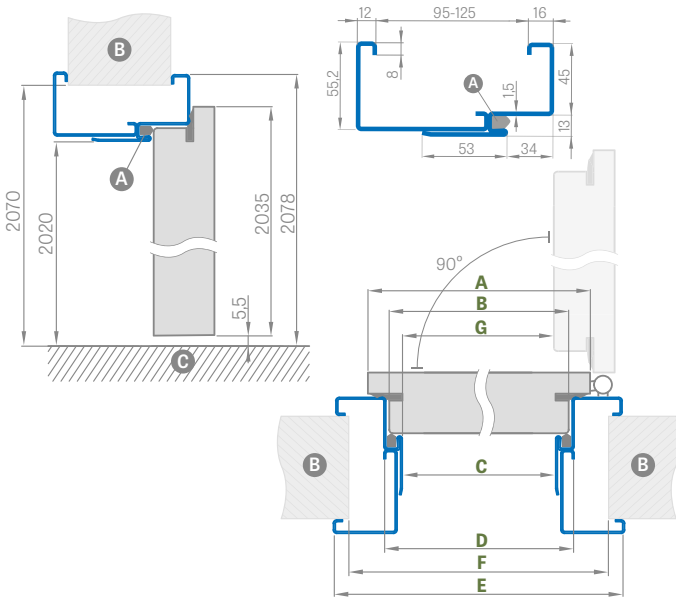

Door width	A	B	C	D	E	F	G
"80N"	804	778	761	787	877	865	754.5
"80"	848	822	805	831	921	910	798.5
"90ES"	960	934	917	943	1033	1022	910
"100" ¹⁾	1048	1022	1005	1031	1121	1110	998.5

¹⁾"90ES" - installation width for a steel door frame

FORTECA RC2 ADJUSTABLE STEEL DOOR FRAME	
Adjustment Range min-max (mm)	
95-125	
125-155	
155-185	
185-215	
215-245	
245-275	
275-305	
305-335	
335-365	

FORTECA RC3 ADJUSTABLE STEEL DOOR FRAME	
Adjustment Range min-max (mm)	
95-125	
125-155	
155-185	
185-215	
215-245	
245-275	
275-305	
305-335	
335-365	

SQUARE STEEL DOOR FRAME, LARGE VERSION

welded and coated in RAL 9010, 9016, 8003, 8017, 7016, 7047, 1001

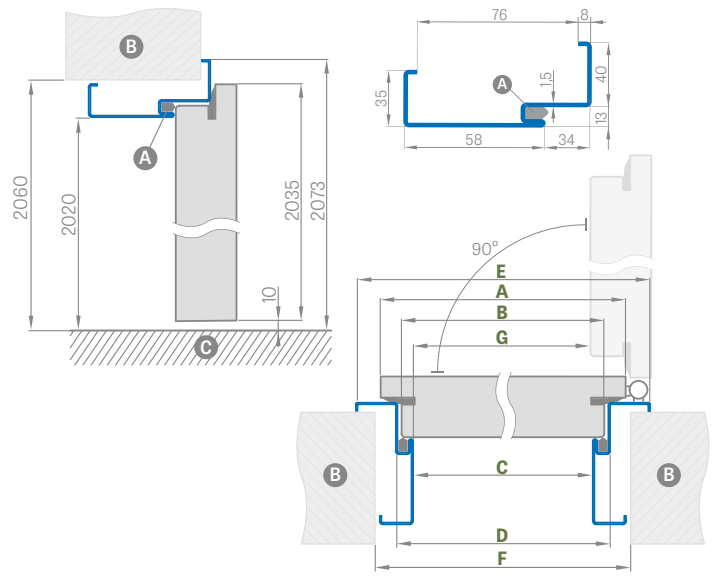

Door width	A	B	C	D	E	F	G
"80N"	804	778	761	787	867	840	754.5
"80"	848	822	805	831	911	885	798.5
"90ES"	960	934	917	943	1023	997	910
"100" ¹⁾	1048	1022	1005	1031	1111	1085	998.5

FITTING THE SQUARE FRAME

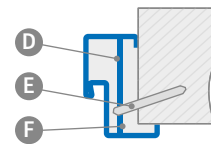

- A** - gasket
- C** - floor
- E** - anchor bolt
- B** - wall
- D** - mounting anchor
- F** - to be filled

EXTRA CHARGES

"100" Square frame, large version

door closer reinforcement

stainless steel threshold

cutting the door with the steel frame to 6 cm in 1 cm increments

galvanised sheet steel

non-typical RAL (intensive, pearly and metallic colours not included)

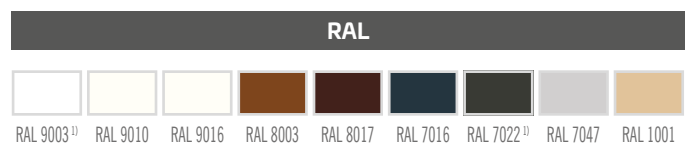

¹⁾ additional charge +10%



HERSE SET 32dB

HERSE SET AKUSTIC 39 dB

FRONT DOORS WITH BURGLAR-PROOF LOCKS OR STRIP LOCKS



HERSE SET LUX 104 with WALNUT GREKO veener with an ESSEN handle



UPPER SECURITY LOCK



LOWER SECURITY LOCK



ADJUSTABLE MAIN KEEPER IN FRAME



ESSEN HANDLE



HERSE SET AKUSTIC 39 dB 46 mm
DOOR LEAF reinforced with sheet steel



46 mm HERSE SET 32 dB DOOR LEAF
with channel bar reinforcement



SOUND INSULATION
32 dB / 39 dB



THREE 2-PIN HINGES; Ø16, 3D ADJUSTABLE



3 HINGE BOLTS



FIXED WOODEN DOOR FRAME



HARDWOOD THRESHOLD (lacquer)



DOOR VIEWER



DROP-DOWN gasket with
pressure adjustment



STAINLESS STEEL THRESHOLD

HERSE DOOR LEAF CROSS-SECTION

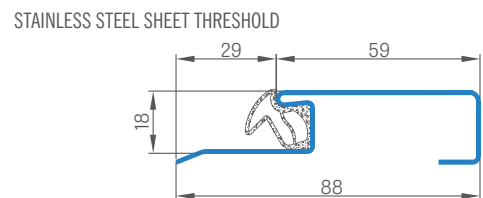
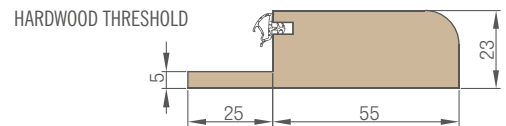
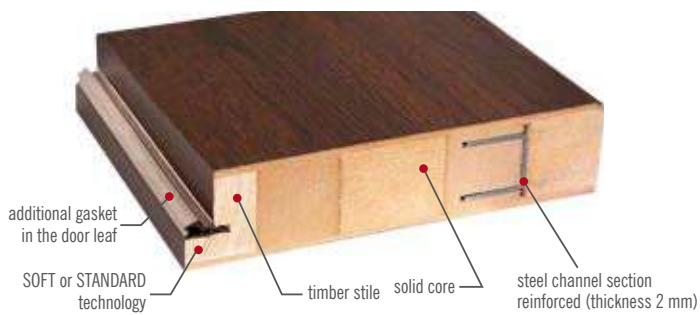



HERSE SET 32dB

HERSE SET AKUSTIC 39 dB

FRONT DOORS WITH BURGLAR-PROOF LOCKS OR STRIP LOCKS



HERSE SET with GREKO WALNUT veneer with ESSEN handle

GENERAL INFORMATION

- HERSE SET doors are designed for housing and public utility building as an entrance internal door (excluding the "80N" width).
- HERSE SET leaf with fixed and adjustable door frame with each of threshold available is rated for sound insulation at $R_w = 32\text{dB}$
- HERSE SET doors in GOLD and SILVER packages are fully preassembled with a threshold fitted, and pre-drilled holes for handle and face plate installation for the GOLD version.

CONSTRUCTION

- timber and MDF stile covered with two HDF boards
- specially designed solid core filling
- robust steel channel section reinforced
- door leaf thickness of 46 mm
- additional gasket in the door leaf

FINISHING

- door leaf edge made in the SOFT or STANDARD technology
- CPL 0.2 & 0.7 laminates available only with the STANDARD edge with the ABS edging in the same colour as the door leaf only or, for an additional charge, with a standard black edge
- 8 mm or 220 mm wide brushed steel, black or OAK CPL inlays flush with the door leaf, on both leaf sides
- STANDARD edge laminated in the same colour as the door leaf or, optionally, plain black edging (NATUR OAK PREMIUM HORIZONTAL, black edge with a transverse structure)
- pre-cut up to 8 cm as an option
- custom order with the lower lock only as an option
- side and top panels glued to the wall (only with the adjustable door frame and an 8 cm square) - page 134

HARDWARE

- three silver 2-pin hinges; $\varnothing 16$; 3D adjustable (2D with a steel frame)
- two 3-pin Class 2 rated security locks with a thumb turn (optionally only lower)
- three hinge bolts on the hinge side
- possibility to apply an arm door closer
- lower lock PZ centre is 72 mm
- optionally, a bolt strip lock with two cores, for an extra charge

REBATED FIXED AND ADJUSTABLE DOOR FRAMES

- optionally, an electric door strike can be used in the door frame for the lower lock with no upper lock in the door leaf.
- adjustable main keeper in frames
- the 80N width is available for the fixed door frame only

GOLD PACKAGE

SILVER PACKAGE

DOOR LEAF

AVAILABLE DOOR LEAF WIDTHS

80N 80 90E 100

EDGE FINISH TYPES



GOLD PACKAGE Door leaf with fixed timber door frame, stainless steel threshold and hardware ¹⁾

SILVER PACKAGE Door leaf with fixed timber door frame, stainless steel threshold, w/o hardware ¹⁾

¹⁾ Hardware includes ESSEN handle in nickel satin, upper face plate, lock cores with 1 key system (upper one with a thumb turn), door viewer (not pre-drilled)

EXTRA CHARGES

door viewer

hardwood threshold (lacquer) for adjustable frames 55 mm or stainless steel threshold with gasket

hardwood threshold (lacquer) for adjustable frames; see table at p. 111

arm door closer (silver, black, white, brown)

door closer reinforcement

drop-down gasket ²⁾

cutting the door leaf with a wooden frame up to 8 cm every and up to 6 cm with a steel frame in the CZ standard

black door leaf edge finish

"100" door leaf or package

30/45 lock core

30G/45 or 30/45G cylinder-holder

30/45 lock core and 30G/45 or 30/45G cylinder-holder in the master key system

metal hinge casings: brushed nickel, patina, polished chrome, polished brass, white or black

ESSEN handle (nickel, satin, patina, black)

ESSEN upper face plate (nickel, satin, patina, black)

LUX inlay; available versions p. 80-81

additional charge for HERSE SET AKUSTIC 39 dB door (added to the GOLD and SILVER packages or leaves)

clip-on square, 3 pcs (extends the adjustment range by 20 m)

magnetic stop (buffer) ²⁾ **NEW**
(available in six colours p. 132)

multi-point bolt strip lock with two locks

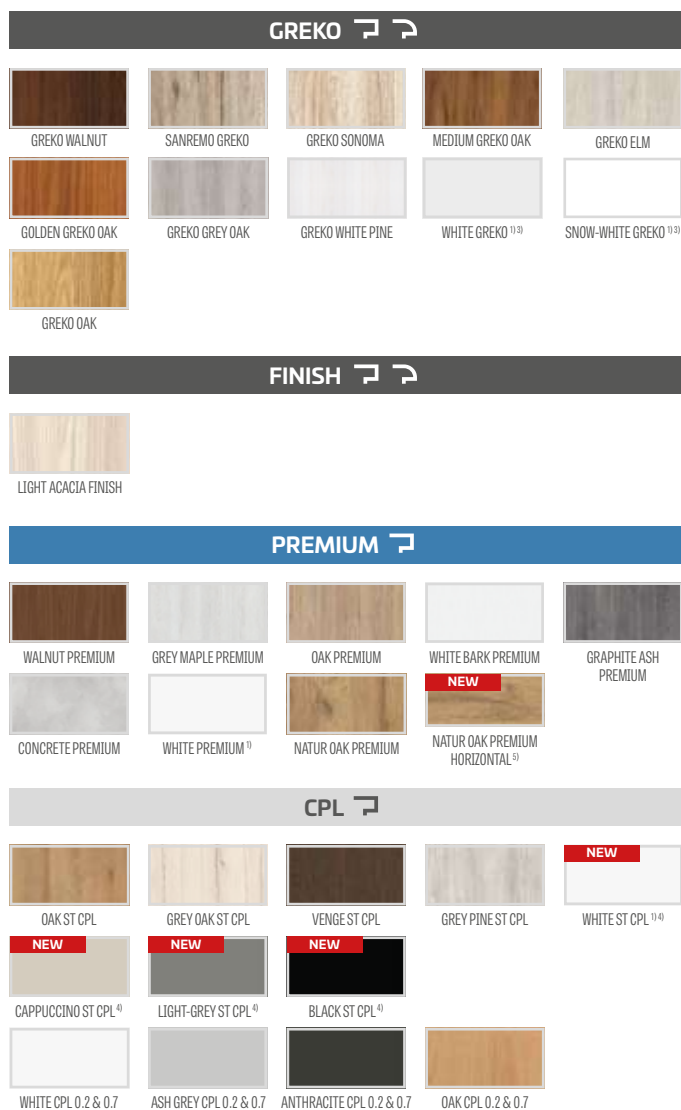

¹⁾ plain white laminate imitating a painted surface

²⁾ a stop prevents application of a drop-down gasket and vice versa

³⁾ available only in STANDARD

⁴⁾ special **AntiFinger** **NEW** coating to reduce dirt and fingerprints

⁵⁾ available as of 01/04/2022



HERSE SET, decor: OAK PREMIUM, ESSEN handle



HERSE MAX SET 32dB

HERSE MAX SET AKUSTIC 39 dB

FRONT DOORS WITH BURGLAR-PROOF LOCKS OR STRIP LOCKS



HERSE MAX SET 23 with OAK PREMIUM laminate with ESSEN handle

GENERAL INFORMATION

- HERSE MAX SET doors are designed for housing and public utility building as an entrance internal door (excluding the "80N" width).
- HERSE MAX SET leaf with fixed and adjustable door frame with each of threshold available is rated for sound insulation at $R_w = 32\text{dB}$ or, for an additional charge, $R_w - 39\text{dB}$
- HERSE MAX SET doors in GOLD and SILVER packages are complete with a threshold, and have pre-drilled holes for handle and face plate installation for the GOLD version.

CONSTRUCTION

- timber and MDF stile covered with two HDF boards
- specially designed solid core filling
- robust steel channel section reinforced
- door leaf thickness of 46 mm
- additional gasket in the door leaf

FINISHING

- STANDARD edge laminated in the same colour as the door leaf or
- optionally, plain black edging (transverse NATUR OAK PREMIUM, black edge with a transverse structure)
- moulded HDF board covered with PREMIUM laminate
- pre-cut up to 8 cm as an option
- side and top panels glued to the wall (only with the adjustable door frame and an 8 cm square) - page 134

HARDWARE

- three silver 2-pin hinges; $\varnothing 16$; 3D adjustable
- two 3-pin Class 2 rated security locks with a thumb turn (optionally only lower)
- three hinge bolts on the hinge side
- possibility to apply an arm door closer
- lower lock PZ centre is 72 mm
- optionally, a bolt strip lock with two cores, for an extra charge

REBATED FIXED AND ADJUSTABLE DOOR FRAMES

- optionally, an electric door strike can be used in the door frame for the lower lock with no upper lock in the door leaf.
- adjustable main keeper in frames
- the 80N width is available for the fixed door frame only

GOLD PACKAGE	SILVER PACKAGE	DOOR LEAF
--------------	----------------	-----------

PREMIUM

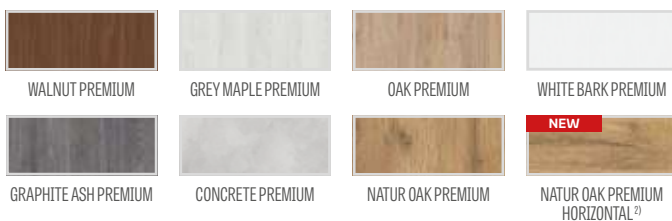

MOULDING

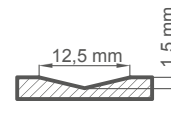

AVAILABLE DOOR LEAF WIDTHS

80N 80 90E 100

EDGE FINISH TYPES

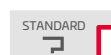

- GOLD PACKAGE** Door leaf with fixed timber door frame, stainless steel threshold and hardware ¹⁾
- SILVER PACKAGE** Door leaf with fixed timber door frame, stainless steel threshold, w/o hardware ¹⁾

¹⁾ hardware includes ESSEN handle in nickel satin, upper face plate, lock cores with 1 key system (upper one with a thumb turn), door viewer (not pre-drilled)

²⁾ available as of 01/04/2022

EXTRA CHARGES

door viewer

black door leaf edge finish

hardwood threshold (lacquer) for adjustable frames 55 mm or stainless steel threshold with gasket

hardwood threshold (lacquer) for adjustable frames; see table at p. 111

arm door closer (silver, black, white, brown)

door closer reinforcement

drop-down gasket ¹⁾

cutting the door leaf with a wooden frame up to 8 cm every and up to 6 cm with a steel frame in the CZ standard

"100" door leaf or package

30/45 lock core

30G/45 or 30/45G cylinder-holder

30/45 lock core and 30G/45 or 30/45G cylinder-holder in the master key system

metal hinge casings: brushed nickel, patina, polished chrome, polished brass, white or black

ESSEN handle (nickel, satin, patina, black)

ESSEN upper face plate (nickel, satin, patina, black)

additional charge for the door HERSE MAX SET AKUSTIC39 dB (added to GOLD and SILVER packages or wing)

clip-on square, 3 pcs (extends the adjustment range by 20 m)

magnetic stop (buffer) ¹⁾ **NEW**
(available in six colours p. 132)

multi-point bolt strip lock with two locks



HERSE MAX SET 24



HERSE MAX SET 25



HERSE MAX SET 26



HERSE MAX SET 27



HERSE MAX SET 28



HERSE MAX SET 29



HERSE MAX SET 30



HERSE MAX SET 31

¹⁾ a stop prevents application of a drop-down gasket and vice versa



FIXED AND ADJUSTABLE FRAMES

HERSE SET, HERSE MAX SET

HERSE SET FIXED DOOR FRAME

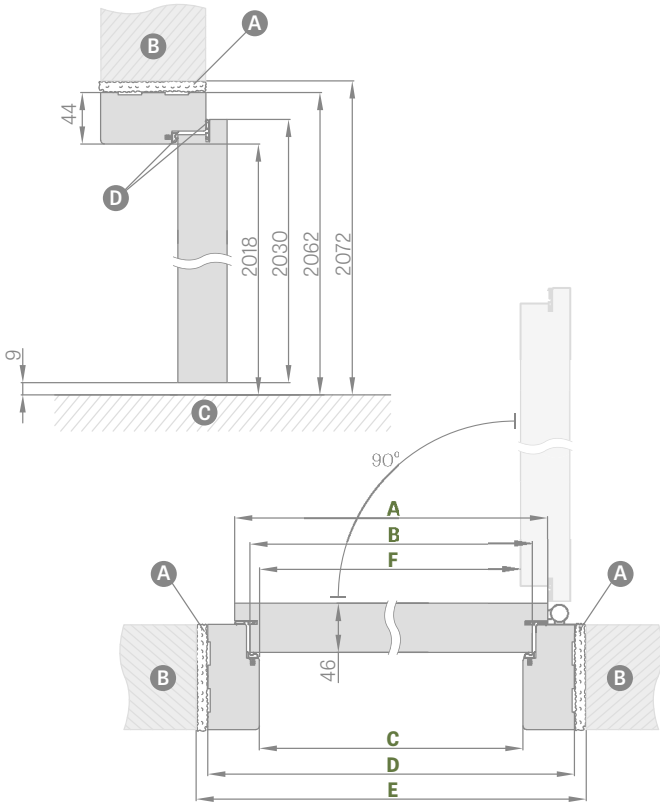

Door width	A	B	C	D	E	F
"80N"	804	777	764	852	872	756
"80"	844	817	804	892	912	796
„90E“	948	921	908	996	1016	900
"100"	1044	1017	1004	1092	1112	996

„90E“ - investment width

HERSE SET ADJUSTABLE DOOR FRAME

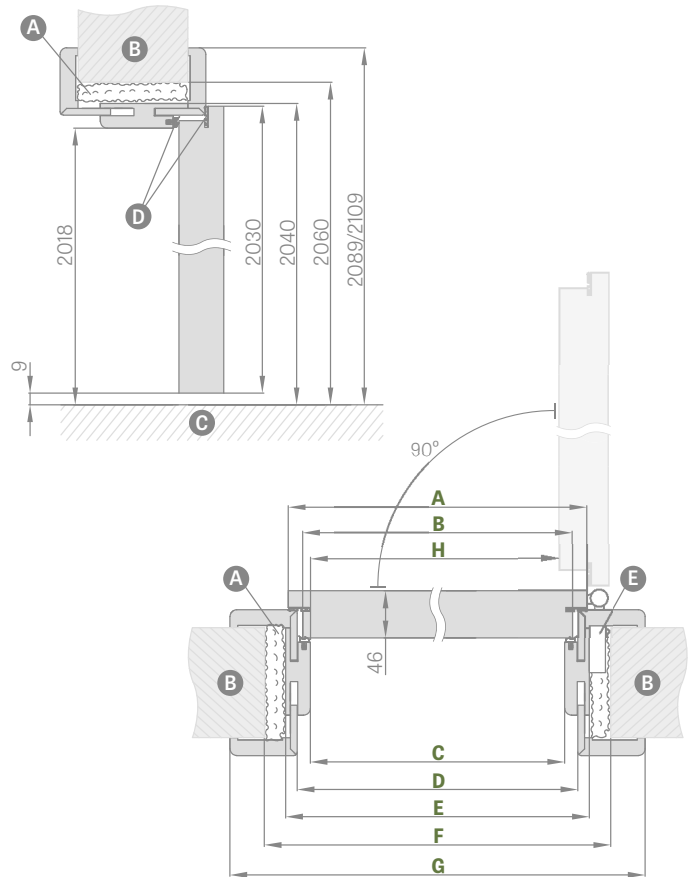

Door width	A	B	C	D	E	F	G	H
"80"	844	817	804	826	848	888	946*/986**	796
„90E“	948	921	908	930	952	992	1050*/1090**	900
"100"	1044	1017	1004	1026	1048	1088	1146*/1186**	996

*strip 6 cm / **strip 8 cm

- A** - installation foam
- B** - wall
- C** - floor
- D** - rubber gasket
- E** - hitching socket

ADJUSTABLE DOOR FRAME RANGE

strip 6 cm / strip 8 cm

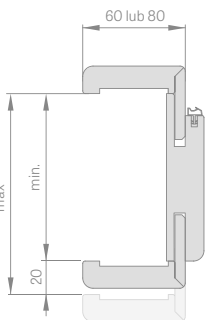

ADJUSTABLE TIMBER THRESHOLD

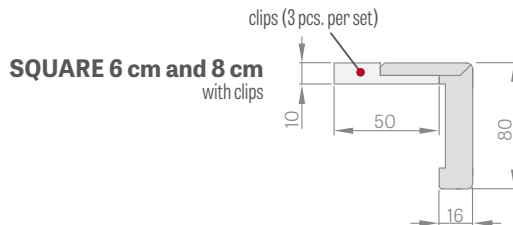
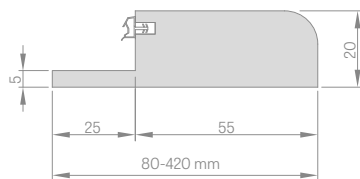

FIXED DOOR FRAME

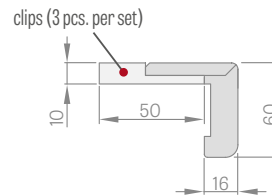
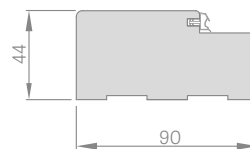

COVER PROFILE

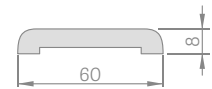

QUARTER ROUND

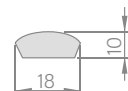

PRICES OF FIXED AND ADJUSTABLE DOOR FRAMES

HERSE SET, HERSE LUX SET & HERSE MAX SET Architraves 6 & 8 cm	
Adjustment Range min-max (mm)	
1 Component	80-100
	100-120
	120-140
	140-160
	160-180
	180-200
	200-220
	220-240
	240-260
	260-280
2 Components	260-300
	280-300
	300-320
	320-340
	340-360
	360-380
3 Components	380-400
	400-420

HERSE SET, HERSE LUX SET, HERSE MAX SET FIXED DOOR FRAME	
FIXED DOOR FRAME	
STRIP	
QUARTER ROUND	

FIXED HARDWOOD THRESHOLD, COLOURLESS LACQUER 55 mm



- The fixed frame, architrave and clip-on square in CPL 0.2 are also used in the set for door leaves in CPL 0.7
- Joints at 90 degrees of the adjustable frame possible with the 8 cm architraves only.
- Electric door strike
- Door closer reinforcement for adjustable door frame –
- Square with three clips (square with clips extends the adjustment range by 20 mm)
- The architraves and quarter round, see price on p. 161
- Side and top panels glued to the wall available (only with an adjustable door frame and an 8 cm strip); see page 134 for pricing
- Cutting the door (leaf and frame) up to 8 cm every 1 cm or the product as per the CZ standard
- Hardwood threshold in the range of 500-520 mm is available on request at an extra charge for every 2 cm, based on 400-420 mm range



STEEL DOOR FRAMES

HERSE SET, HERSE MAX SET

ADJUSTABLE STEEL DOOR FRAME (OVERLAPPING)

welded and coated in RAL 9010, 9016, 8003, 8017, 7016, 7047, 1001

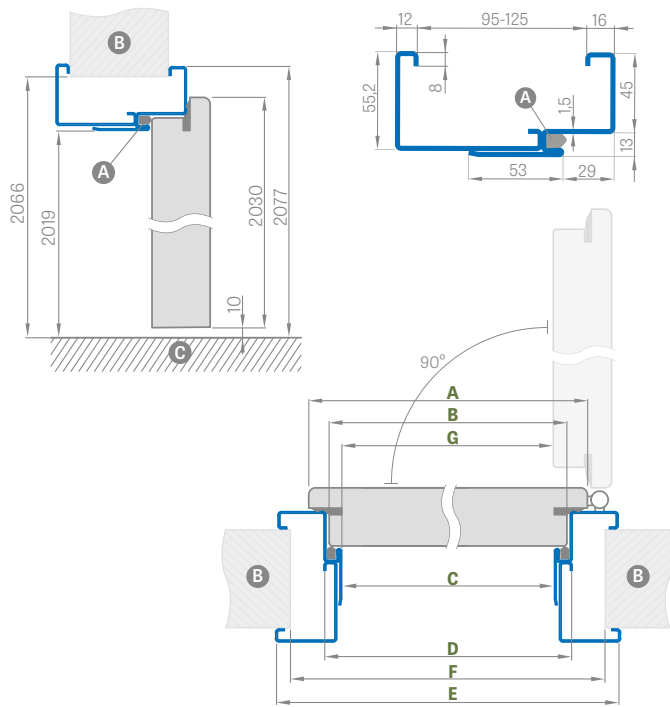

Door width	A	B	C	D	E	F	G
"80N"	804	777	761	787	877	855	756
"80"	844	817	801	827	917	895	796
„90ES"	948	921	905	931	1021	999	900
"100"	1044	1017	1001	1027	1117	1095	996

„90ES" – installation width for a steel door frame

Adjustment Range min-max (mm)
95-125
125-155
155-185
185-215
215-245
245-275
275-305

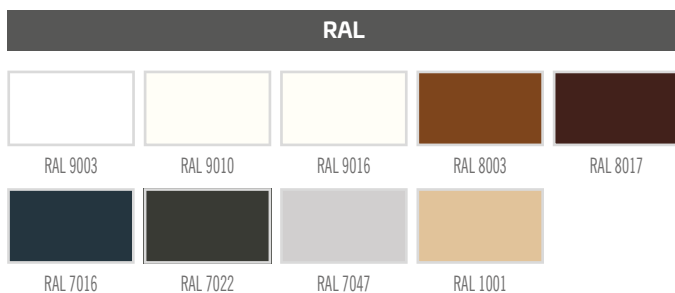

SQUARE STEEL DOOR FRAME, LARGE VERSION HERSE SET

welded and coated in RAL 9010, 9016, 8003, 8017, 7016, 7047, 1001

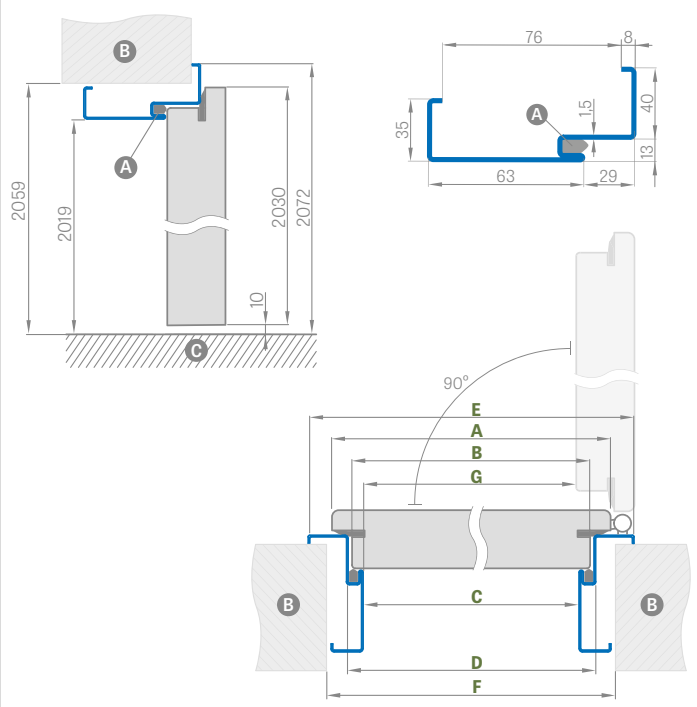

Door width	A	B	C	D	E	F	G
"80N"	804	777	761	787	867	841	756
"80"	844	817	801	827	907	881	796
„90ES"	948	921	905	931	1011	985	900
"100"	1044	1017	1001	1027	1107	1081	996

FITTING THE SQUARE FRAME

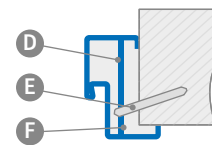

- A** – gasket
- B** – wall
- C** – floor
- D** – mounting anchor
- E** – anchor bolt
- F** – to be filled

EXTRA CHARGES

"100" square frame, large version

electric door strike

door closer reinforcement

cutting the door with the steel frame to 6 cm in 1 cm increments

stainless steel threshold

galvanised sheet steel

+10%

non-typical RAL (intensive, pearly and metallic colours not included)

+10%



UNITED STEEL DOOR FRAME

HERSE SET, HERSE MAX SET

UNITED STEEL DOOR FRAME DIAGRAM

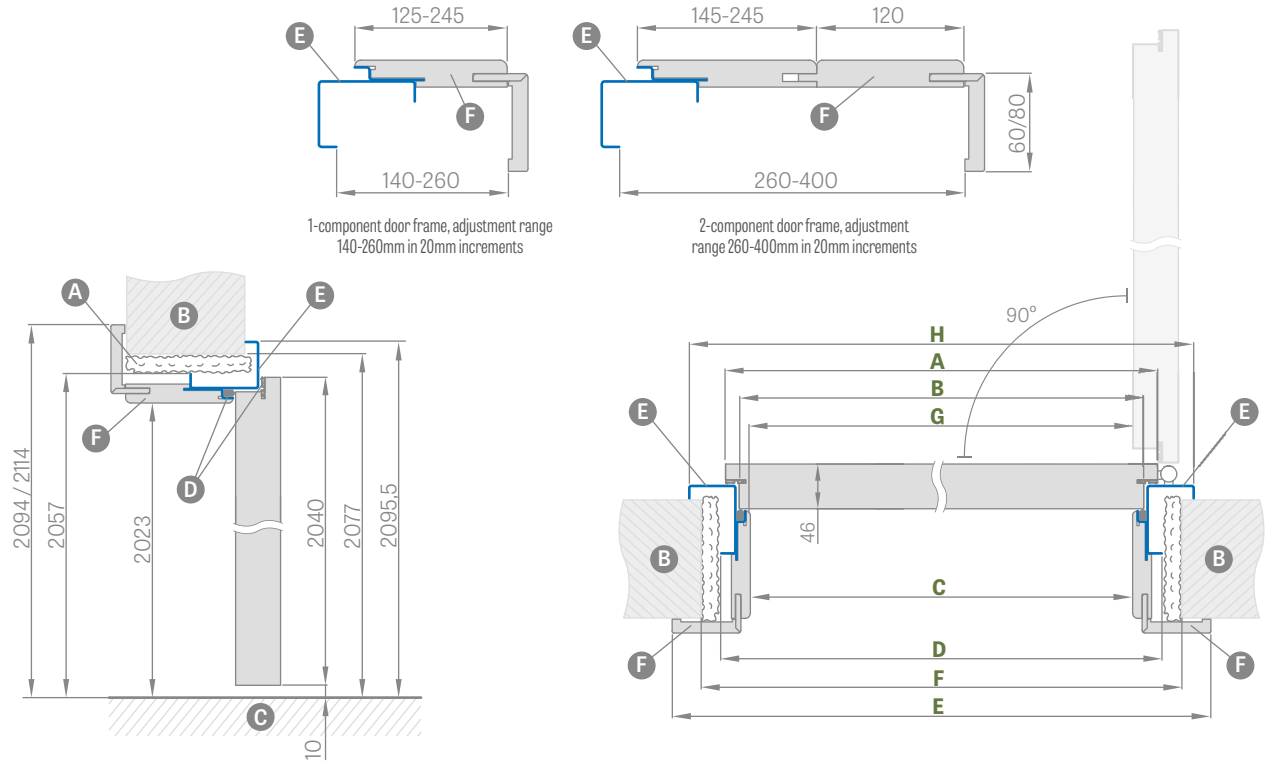

Door width	A	B	C	D	E	F	G	H
„80U“	844	817	791.5	859	933.5/973.5	899	790	935
„90EU“	960	933	907.5	975	1049.5/1089.5	1015	906	1051
„100U“	1044	1017	991.5	1059	1133.5/1173.5	1099	990	1135

90EU – installation width for a steel door frame UNITED

- A** – installation foam
- B** – wall
- C** – floor
- D** – rubber gasket
- E** – steel part painted in RAL colour
- F** – part MDF laminate

EXTRA CHARGES

electric door strike	
door closer reinforcement	
shortening of a leaf with a UNITED steel door frame up to 6 cm in 1 cm increments	
stainless steel threshold, height: 20 mm	
galvanised sheet steel	+10%
non-typical RAL (intensive, pearly and metallic colours not included)	+10%

	Adjustment range min-max (mm)
1 component	140-160
	160-180
	180-200
	200-220
	220-240
	240-260
2 Components	260-280
	280-300
	300-320
	320-340
	340-360
	360-380
	380-400

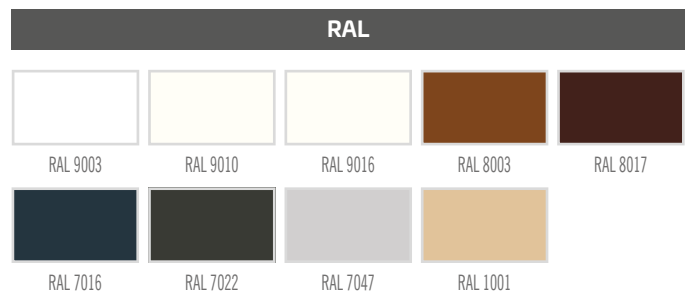



LEDA EI30, EI60

FIRE INTERNAL FRONT DOORS MADE IN HALSPAN TECHNOLOGY



ADJUSTABLE STEEL DOOR FRAME (OVERLAPPING)

Adjustment range min-max (mm)
95-125
125-155
155-185
185-215
215-245
245-275
275-305

GREKO

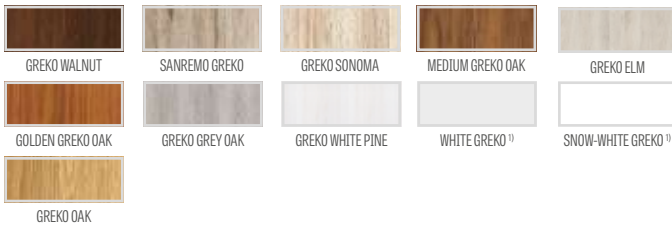

FINISH

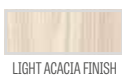

CPL

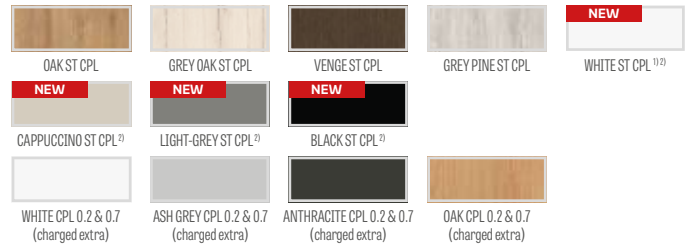

PREMIUM

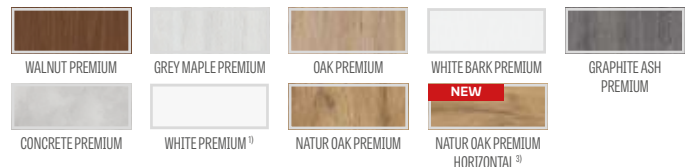

¹⁾ plain white laminate imitating a painted surface
²⁾ special **AntiFinger** **NEW** coating to reduce dirt and fingerprints
³⁾ available as of 01/04/2022

GENERAL INFORMATION

Fire protection, smoke control and sound insulation are ensured only when a complete doorset is installed, including a fire door leaf (with gaskets, lock, hinges and drop-down gasket pre-assembled), door frame, door closer, as well as a lock core and handle in compliance with the Polish Standard.

The sound insulation of the HALSPAN door system supplied with a drop-down gasket as per PN-B-02151-03:1999 is rated at $R_w=32$ dB

The door leaves are marketed complete with a timber or steel door frame only.

CONSTRUCTION

- filled with a special HALSPAN board with a thickness of 44 mm for Type EI30 and 54 mm for EI60
- overall door leaf thickness 50 mm in EI30 and 60 mm in EI60
- softwood door frame
- fire rated and smoke intumescent door gasket
- drop-down gasket
- transparent fire-resistant glass; the glass width is fixed (not dependent on) the door leaf width

FINISHING

- leaf edge made in the STANDARD technology (with CPL 0.2 & 0.7 laminates, with the ABS edging in the same colour as the leaf only or with a standard black edge for an additional charge)
- 8 mm or 220 mm wide brushed steel, brushed gold, black or OAK CPL inlays flush with the door leaf, on both leaf sides. Applies to LEDA full only. Inlay types shown on pages 78-81
- two-sided inlays only in full leaf and on only on the active leaf in double-leaf doors
- the edge laminated in the same colour as the door leaf or, optionally plain black (NATUR OAK PREMIUM HORIZONTAL, black edge with a transverse structure)
- side and top panels glued to the wall (only when fitted with an 8 cm square) - page 134

HARDWARE

- four hinges; $\varnothing 16$; 3D adjustable (2D for the steel frame)
- thumb turn cylinder lock
- door closer for an additional charge

DOOR FRAMES

- fire rated fixed door frame
- fire rated gasket
- adjustable door striker plate
- adjustable steel, square large or welded frames in RAL 9010, 8003, 8017, 7035, 7016, 1005
- fixed frame made of black sheet metal, thickness 1.5 mm, RAL powder painted, welded in the corners, fitted with a fire rated gasket and door closer reinforcement as standard.

EXTRA CHARGES

fire rated arm door closer in colours: silver, black, white, brown

fire rated cam-action door closer (only for frames with or without housing with a clip-on square) in colours: silver, black, white, brown

fire rated ventilation grille

JOWISZ INOX handle, long face plate, lock core, see p. 127

30/40 lock core (EI30) or 30/50 (EI60)

fire-proof door viewer, satin, chrome

metallic hinge casings (matt chrome, black)

fire rated upper deadbolt lock

black door leaf edge finish

housing for EI30 from 100 to 460 and housing for EI60 from 120 to 480 every 40 mm double door housing

fire rated electric door strike (standard) 12/24V (not for a steel door frame)

steel door frame in RAL not in the range (intensive, pearl and metallic colours not included)

steel door frame made of galvanised sheet steel

EI30

extra charge for type 3 glazing

extra charge for type 4 glazing

extra charge for type 5, 7 glazing

extra charge for type 6, 8 glazing

EI60

extra charge for type 4 glazing

extra charge for type 6, 8 glazing

LUX INLAY: available versions p. 80-81

(on both sides on a full door leaf, and on an active double-leaf only)

CPL 0.2 laminate (for doors w/o housing)

CPL 0.7 laminate (for doors w/o housing)

clip-on square ¹⁾

(the clip-on square extends the adjustment range by 20 mm)

additional charge for the "110" leaf

side and top panels glued to the wall available (only with a wall installed door frame and an 8 cm square)

¹⁾ in the version with housing, the clip-on square is included



LEDA EI30, EI60

SINGLE-LEAF DOOR

FIXED WOODEN DOOR FRAME

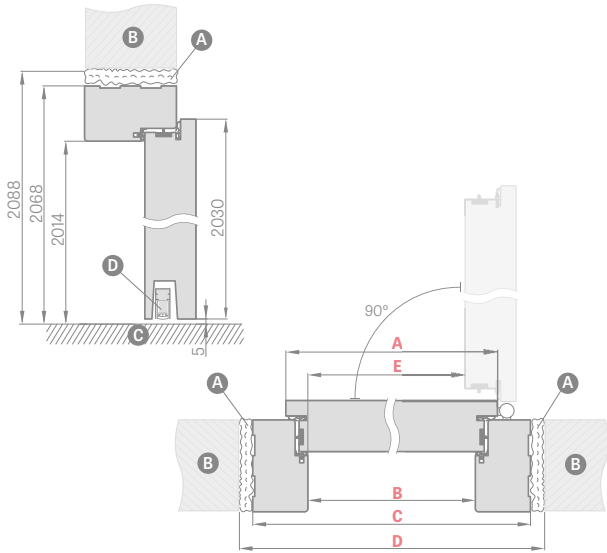

Door width	A	B	C	D	E
"80"	860	817	925	955	805
"90E"	960	917	1025	1055	905
"100"	1060	1017	1125	1155	1005
"110"	1160	1117	1225	1255	1105

- A** fire-resistant installation foam
- B** wall
- C** floor
- D** drop-down gasket

„90E“ - investment width

FIRE RATED DOOR FRAME CROSS-SECTION IN MASONRY AND WITH CLIP-ON SQUARE

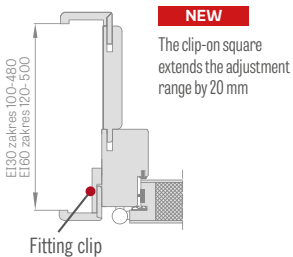

FIRE RATED DOOR FRAME CROSS-SECTION IN BASIC MASONRY

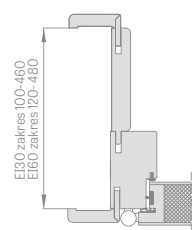

SQUARE 6 cm and 8 cm with clips

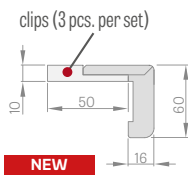
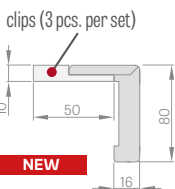

FIRE RATED FIXED DOOR FRAME CROSS-SECTION

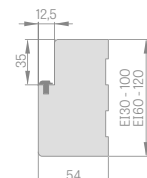

CAM-ACTION DOOR CLOSER 1)



ARM DOOR CLOSER



ADJUSTABLE STEEL FIRE DOOR FRAME (OVERLAPPING)

welded and coated in RAL 9003, 9010, 9016, 8003, 8017, 7016, 7022, 7047, 1001

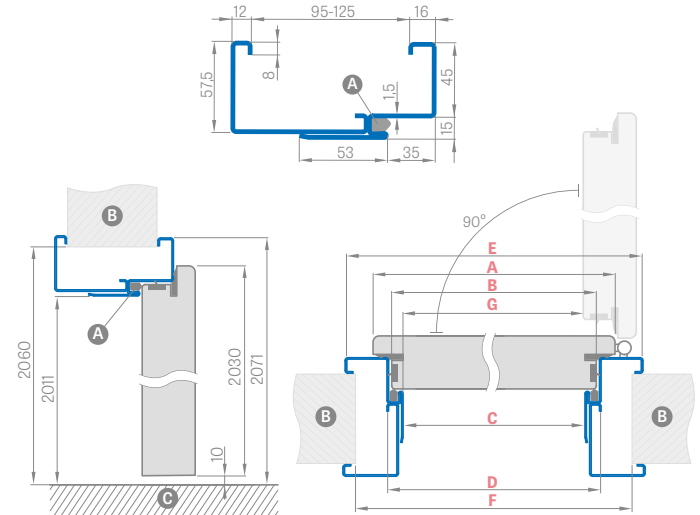

Door width	A	B	C	D	E	F	G
"80"	860	834	813	843	933	910	802
"90ES"	960	934	913	943	1033	1010	902
"100"	1060	1034	1013	1043	1133	1110	1002
"110"	1160	1134	1113	1143	1233	1210	1102

„90ES“ - installation width for a steel door frame

LARGE STEEL FIRE SQUARE DOOR FRAME (OVERLAPPING)

welded and coated in RAL 9003, 9010, 9016, 8003, 8017, 7016, 7022, 7047, 1001

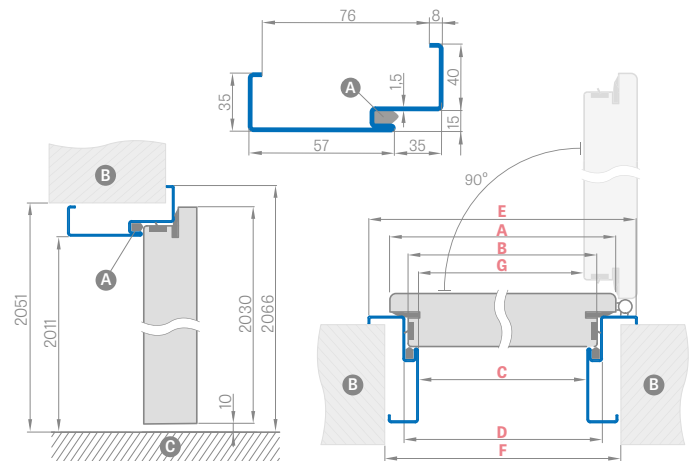

Door width	A	B	C	D	E	F	G
"80"	860	834	813	843	923	890	802
"90ES"	960	934	913	943	1023	990	902
"100"	1060	1034	1013	1043	1123	1090	1002
"110"	1160	1134	1113	1143	1223	1190	1102

RAL



RAL 9003²⁾ RAL 9010 RAL 9016 RAL 8003 RAL 8017 RAL 7016 RAL 7022²⁾ RAL 7047 RAL 1001

¹⁾ use the cam-action door closer for a fixed door frame only or for frames with a clip-on square

²⁾ additional charge +10%



LEDA EI30, EI60

DOUBLE-LEAF DOORS

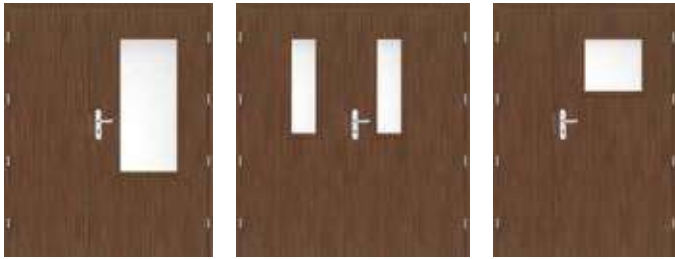

LEDA 3 "90E" + passive "60" door leaf LEDA 6 "90E" + passive "80" door leaf LEDA 4 "90E" + "40" side panel

LEDA EI30 & EI60 DOUBLE-LEAF DOORS

- the double-leaf doors are made within the LEDA EI30 and EI60 ranges with prices depending on the colour and finish (STANDARD);
- the passive leaf is made in two versions:
 - Plain; widths: "60", "70", "80"
 - glazed in types 5, 6, 7, 8 for EI30 and glazed in types 6 and 8 for EI 60
- side panel for the widths of "30", "40" and "50"; fully plain in each variant;
- the passive leaf and side panel are supplied with shootbolt locks and bolt keepers; w/o edging strips.

AVAILABLE ACTIVE DOOR LEAF WIDTHS FOR DIFFERENT FIRE DOOR TYPES

LEDA EL30 EL60 80 90E 100	LEDA Type 3 glazing EL30 90E 100	LEDA Type 4 glazing EL30 EL60 90E 100	LEDA Type 5 glazing EL30 80 90E 100
LEDA Type 6 glazing EL30 EL60 80 90E 100	LEDA Type 7 glazing EL30 80 90E 100	LEDA Type 8 glazing EL30 EL60 80 90E 100	

AVAILABLE PASSIVE DOOR LEAF WIDTHS FOR DIFFERENT FIRE DOOR TYPES

LEDA EL30 EL60 60 70 80	LEDA Type 5 glazing EL30 70 80	LEDA Type 6 glazing EL30 EL60 70 80
LEDA Type 7 glazing EL30 70 80	LEDA Type 8 glazing EL30 EL60 70 80	

DOUBLE-LEAF DOOR PRICE

The price includes

- active part = price of full single leaf door, plus possible extra charges as for single leaf doors
- passive part = price for the solid version (also side panel), plus possible extra charges as for single leaf doors

AVAILABLE DOOR LEAF WIDTHS

active leaf **80 90E 100** + passive leaf **60 70 80**
 active leaf **80 90E 100** + full, plain side panel **30 40 50**

	DOUBLE FIRE DOOR TIMBER DOOR FRAME								
	"110"	"120"	"130"	"140"	"150"	"160"	"170"	"180"	
A Active door leaf width	860	860 960	860 960 1060	860 960 1060	860 960 1060	860 960 1060	960 1060	1060	
B Passive door leaf/Side panel widths	347	447 347	547 447 347	647 547 447	747 647 547	847 747 647	847 747	847	
C Frame opening width	1170	1270	1370	1470	1570	1670	1770	1870	
F Frame outer width	1278	1378	1478	1578	1678	1778	1878	1978	
E Opening width in the wall	1310	1410	1510	1610	1710	1810	1910	2010	

ADJUSTABLE STEEL FIRE DOOR FRAME (OVERLAPPING)

Welded and coated in RAL 9010, 9016, 8003, 8017, 7016, 7047, 1001

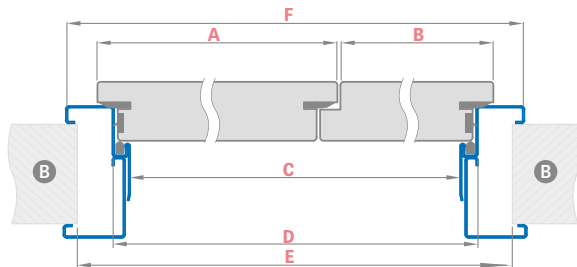

LARGE STEEL FIRE SQUARE DOOR FRAME (OVERLAPPING)

Welded and coated in RAL 9010, 9016, 8003, 8017, 7016, 7047, 1001

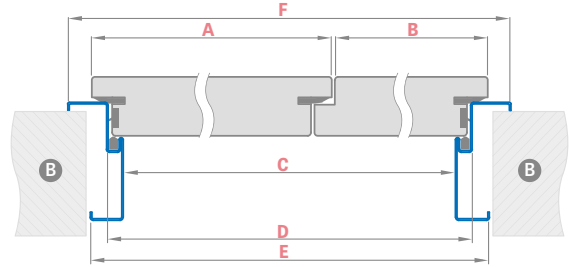

Door width	A	B	C	D	E	F
"110"	860	347	1166	1196	1270	1287
"120"	860 960	447 347	1266	1296	1370	1387
"130"	860 960 1060	547 447 347	1366	1396	1470	1487
"140"	860 960 1060	647 547 447	1466	1496	1570	1587
"150"	860 960 1060	747 647 547	1566	1596	1670	1687
"160"	860 960 1060	847 747 647	1666	1696	1770	1787
"170"	960 1060	847 747	1766	1796	1870	1887
"180"	1060	847	1866	1896	1970	1987

Door width	A	B	C	D	E	F
"110"	860	347	1166	1196	1236	1276
"120"	860 960	447 347	1266	1296	1336	1376
"130"	860 960 1060	547 447 347	1366	1396	1436	1476
"140"	860 960 1060	647 547 447	1466	1496	1536	1576
"150"	860 960 1060	747 647 547	1566	1596	1636	1676
"160"	860 960 1060	847 747 647	1666	1696	1736	1776
"170"	960 1060	847 747	1766	1796	1836	1876
"180"	1060	847	1866	1896	1936	1976



HYPERION E130 RC2 39dB

INTERNAL FRONT FIRE AND BURGLAR-PROOF DOORS MADE IN THE ERKADO TECHNOLOGY



SOUND INSULATION
39dB

HYPERION with NATUR OAK PREMIUM laminate and a BONNN handle, LUX 213 inlay

AVAILABLE DOOR LEAF WIDTHS

80 90E 100

DOOR LEAF WITH FIXED TIMBER DOOR FRAME

HYPERION E130 Leaf + fixed timber door frame

„80“

„90E“

„100“

„90E“ - investment width

RC2 – Important:

For compliance with RC2 burglary resistance class as per the PN-EN 1627:2012, the hardware should meet the following requirements:

- min Class 2 as per PN-EN 1906:2012 – for handles and door face plates
- min Class 4 and 1 as per PN-EN 1303:2015 – for lock cylinders

GREKO

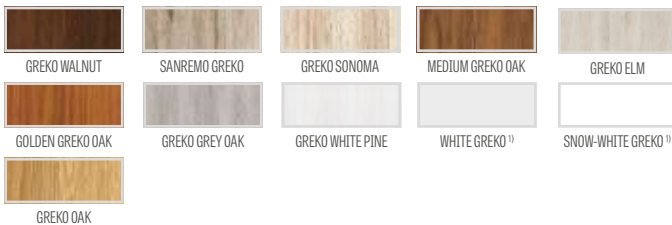

FINISH



LIGHT ACACIA FINISH

CPL

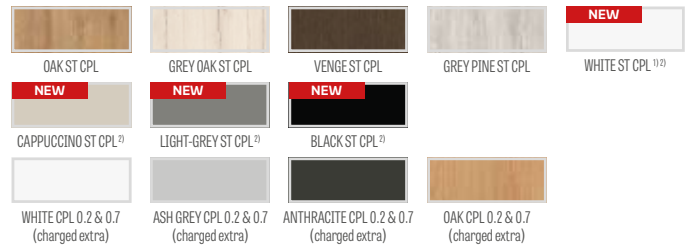

PREMIUM

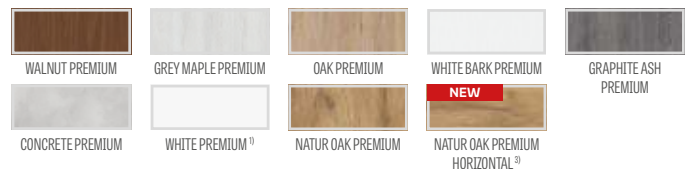

¹⁾ plain white laminate imitating a painted surface

²⁾ special **AntiFinger** **NEW** coating to reduce dirt and fingerprints

³⁾ available as of 01/04/2022

GENERAL INFORMATION

Fire protection, smoke control and sound insulation are ensured only when a complete doorset is installed, including a fire door leaf (with gaskets, lock, hinges and drop-down gasket pre-assembled), door frame, door closer, as well as a lock core and handle in compliance with the Polish Standard.

The sound insulation of the door with a drop-down gasket as per N-B-02151-03:1999 is rated at $R_w=39$ dB

The door leaves are sold complete with a wooden door frame only.

The doors have an anti-burglary RC2 certificate for inward opening doors.

CONSTRUCTION

- special 44 mmthick filling
- total door leaf thickness of 50 mm
- softwood door frame
- fire rated and smoke intumescent door gasket
- drop-down gasket

FINISHING

- leaf edge made in the STANDARD technology (with CPL 0.2 & 0.7 laminates, with the ABS edging in the same colour as the leaf only or with a standard black edge for an additional charge)
- 8 mm or 220 mm wide brushed steel, black or OAK CPL inlays flush with the door leaf, on both leaf sides
- the edge laminated in the same colour as the door leaf or, optionally plain black (transverse NATUR OAK PREMIUM, black edge with a transverse structure)
- side and top panels glued to the wall (only when fitted with an 8 cm square) - page 134

HARDWARE

- four hinges; $\varnothing 16$; 3D adjustable
- multi-point bolt strip lock with two locks
- door closer for an additional charge

DOOR FRAMES

- fixed wooden fire protection door frame optionally with cladding
- fire rated gasket
- adjustable door striker plate

FIRE RATED DOOR FRAME CROSS-SECTION IN MASONRY AND WITH CLIP-ON SQUARE

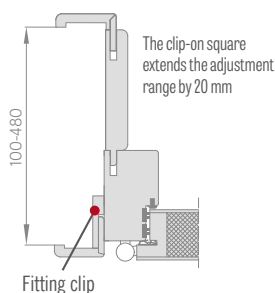

FIRE RATED DOOR FRAME CROSS-SECTION IN BASIC MASONRY

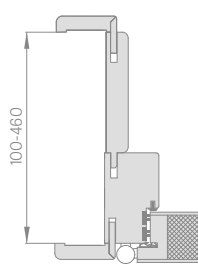

CAM-ACTION DOOR CLOSER ²⁾
(silver, black, white, brown)



ARM DOOR CLOSER
(silver, black, white, brown)



¹⁾ In the version with housing, the clip-on square is included

²⁾ Use the cam-action door closer for a fixed door frame only or for frames with a clip-on square

EXTRA CHARGES

fire rated arm door closer in colours: silver, black, white, brown

fire rated cam-action door closer (only for frames with or without housing with a clip-on square) in colours: silver, black, white, brown

BONN handle, long face plate, lock core, see p. 127

BONN face plate (page 127)

metallic hinge casings (matt chrome, black)

two silver lock cores set (one with a thumbturn) in a master key system for RC2 doors (class 4 & 1 as per PN-EN 1303:2015)

fire-proof door viewer, satin, chrome

black door leaf edge finish

cladding for EI30 from 100 to 480 mm

LUX inlay; available versions p. 80-81

CPL 0.2 laminate (for doors w/o housing)

CPL 0.7 laminate (for doors w/o housing)

clip-on square ¹⁾ (the clip-on square extends the adjustment range by 20 mm)

side and top panels glued to the wall available (only with a wall installed door frame and an 8 cm square)

FIXED WOODEN DOOR FRAME

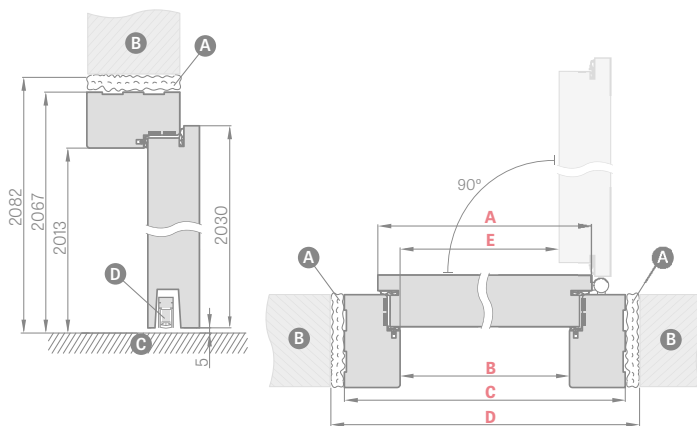

Door width	A	B	C	D	E
"80"	860	817	925	955	805
"90E"	960	917	1025	1055	905
"100"	1060	1017	1125	1155	1005

"90E" - investment width

A fireproofing foam **B** masonry **C** floor **D** drop gasket

SQUARE 6 cm and 8 cm with clips

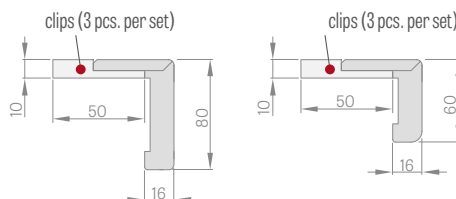

FIRE RATED FIXED DOOR FRAME CROSS-SECTION



HARDWARE

HANDLES FOR PANEL, STILE DOOR LEAVES

The handle not to be used for panel door leaves with casing frames, see p. 158

NEW

RUMBA handle with antibacterial coating with active silver ions

black matt



black matt



key face plate
face plate
anti-bacterial toilet sign knob



METAL-BUD LUNA PREMIUM handle, SQUARE

glossy chrome, brushed matt chrome, glossy brass, black matt

Metal-Bud

PRODUCENT KLAMEK



glossy chrome



brushed matt chrome



glossy brass



black matt



key face plate
face plate
face plate for toilet door

PREMIUM CLASS HANDLE
PREMIUM

METAL-BUD LUNA PREMIUM handle, ROUND

glossy chrome, brushed matt chrome, glossy brass, black matt

Metal-Bud

PRODUCENT KLAMEK



glossy chrome



brushed matt chrome



glossy brass



black matt



key face plate
face plate
face plate for toilet door

PREMIUM CLASS HANDLE
PREMIUM

HANDLES FOR PANEL, STILE DOOR LEAVES

The handle not to be used for panel door leaves with casing frames, see p. 158

METAL-BUD CUBE SLIM handle (face plate width 6 mm)

glossy chrome, brushed matt chrome, glossy brass, black matt

Metal-Bud

PRODUCENT KLAMEK



glossy chrome

brushed matt chrome

glossy brass

brass satin

black matt



key face plate
face plate
face plate for toilet door

PREMIUM CLASS HANDLE
PREMIUM

METAL-BUD CUBE handle

glossy chrome, brushed matt chrome, brushed matt nickel, black matt

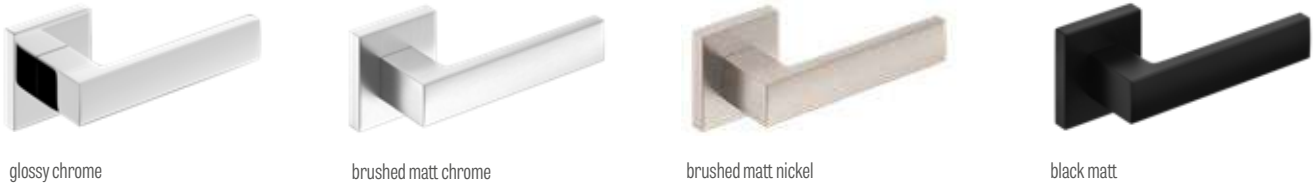

glossy chrome

brushed matt chrome

brushed matt nickel

black matt



key face plate
face plate
face plate for toilet door

PREMIUM CLASS HANDLE
PREMIUM

METAL-BUD CUBE PREMIUM handle

glossy chrome, brushed matt chrome, brushed matt nickel, black matt



glossy chrome

brushed matt chrome

brushed matt nickel

black matt



key face plate
face plate
face plate for toilet door

PREMIUM CLASS HANDLE
PREMIUM

HANDLES FOR PANEL, STILE DOOR LEAVES

The handle not to be used for panel door leaves with casing frames, see p. 158

METAL-BUD BELLA SLIM SQUARE (prestige face plate of 6 mm in thickness)

glossy chrome, brushed matt chrome, glossy brass, black matt

Metal-Bud

PRODUCENT KLAMEK



glossy chrome

brushed matt chrome

glossy brass

brass satin

black matt

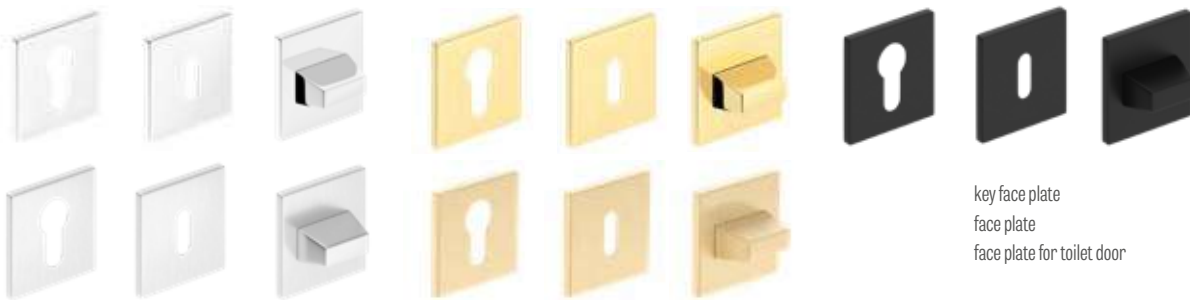

key face plate
face plate
face plate for toilet door

METAL-BUD BELLA SLIM ROUND (prestige face plate of 6 mm in thickness)

glossy chrome, brushed matt chrome, glossy brass, black matt



glossy chrome

brushed matt chrome

glossy brass

brass satin

black matt



key face plate
face plate
face plate for toilet door

PREMIUM CLASS HANDLE
PREMIUM

METAL-BUD TREND handle

Nickel satin, graphite/chrome, glossy chrome



nickel satin

graphite/chrome

glossy chrome



key face plate
face plate
face plate for toilet door

HANDLES FOR PANEL, STILE DOOR LEAVES

The handle not to be used for panel door leaves with casing frames, see p. 158

METAL-BUD DECO texture handle

glossy chrome, nickel satin

Metal-Bud

PRODUCENT KLAMEK



decor: MEDIUM GREKO OAK



decor: BLACK



decor: WHITE GREKO



decor: GREKO SONOMA



decor: GREKO WALNUT



decor: GREKO OAK



decor: SANREMO GREKO

METAL-BUD IBIZA handle

glossy chrome, nickel satin, graphite/chrome, white matt, black matt



glossy chrome



graphite/chrome



nickel satin



white matt



black matt

METAL-BUD LINEA handle

Glossy chrome, graphite/chrome, nickel, satin



glossy chrome



graphite/chrome



nickel satin

FACE PLATE glossy chrome, nickel satin, graphite/chrome, white matt, black matt for the **DECO, IBIZA, LINEA** models



key face plate
face plate
face plate for toilet door



HANDLES FOR PANEL, STILE DOOR LEAVES

The handle not to be used for panel door leaves with casing frames, see p. 158

METAL-BUD QUBIK handle

nickel velvet, chrome glossy, white matt, black matt

Metal-Bud

PRODUCENT KLAMEK



QUBIK handle nickel, velvet



QUBIK handle chrome glossy



QUBIK handle, white matt



QUBIK handle, black matt



QUBIK handle brass glossy

NEW

METAL-BUD BARCELONA handle

nickel, velvet, glossy chrome, black matt



BARCELONA handle nickel, velvet



BARCELONA handle glossy chrome



BARCELONA handle, black matt



BARCELONA handle brushed nickel

NEW

FACE PLATE nickel, velvet, glossy chrome, white matt, black matt glossy brass for the **QUBIK, BARCELONA** models



key face plate, face plate, face plate for toilet door

GAMET handles

brushed chrome, glossy chrome, brushed nickel, antique brass



MISTICO handle
glossy chrome



MISTICO handle
brushed nickel



face plate for key and lock core
face plate for toilet door



ERBA handle
brushed nickel



ERBA handle
antique brass



face plate for key and lock core
face plate for toilet door



CASCADA handle
brushed nickel



CASCADA handle
antique brass



face plate for key and lock core
face plate for toilet door

HANDLES FOR PANEL, STILE DOOR LEAVES

The handle not to be used for panel door leaves with casing frames, see p. 158

METAL-BUD ERKADO handle

black matt



TOPAZ handle, black matt



face plate



key face plate



face plate for toilet door

METAL-BUD ERKADO handles

inox



NEW

SUPRA inox square handle



NEW

SUPRA inox round handle



NEW

PROXIMA inox round handle



SAPPHIRE inox handle



METRO inox handle



PROXIMA inox square handle



TOPAZ inox handle



ONYX inox handle



NOVA inox square handle



NOVA inox round handle



JOWISZ inox handle



ROMA inox handle



face plate inox



key face plate inox



face plate for toilet door inox



face plate inox



key face plate inox



face plate for toilet door inox

HANDLES FOR PANEL, STILE DOOR LEAVES

The handle not to be used for panel door leaves with casing frames, see p. 158

NEW

BLANKA and ARTEMIDA handles

satin chrome, patina, matt black



BLANKA handle chrome, satin



BLANKA handle, black matt



ARTEMIDA handle patina



ARTEMIDA handle, black matt



face plate for key and lock core

face plate for key and lock core satin patina and chrome



face plate for toilet door

face plate for toilet door satin chrome and patina



HANDLES FOR PLATE, STILE LEAVES, WITH LONG FACE PLATE

The handle not to be used for panel door leaves with casing frames, see p. 158. (DOES NOT APPLY TO SYDNEY and QUBIK handles, long face plate).
The handles with a long face plate are not to be used for non-rebated doors (see p. 132)

NEW

BLANKA and ARTEMIDA handles long face plate

satin chrome, patina, matt black



BLANKA handle chrome, satin
face plate for key and lock core, economy lock



BLANKA handle black
face plate for key and lock core, economy lock



ARTEMIDA handle patina
face plate for key and lock core, economy lock



ARTEMIDA handle, black
face plate for key and lock core, economy lock

BLANKA handle chrome, satin
face plate for toilet door

BLANKA handle black
face plate for toilet door

ARTEMIDA handle patina
face plate for toilet door

ARTEMIDA handle, black
face plate for toilet door

METAL-BUD ASTRA, SYDNEY and QUBIK handles, long face plate, spacing 72 mm

- the SYDNEY and QUBIK handles not to be used for panel door leaves with casing frames, see p. 158

nickel, patina



ASTRA handle
nickel, patina
Key face plate



SYDNEY handle
nickel, patina
Key face plate



QUBIK handle long face plate
black
Key face plate



ASTRA and SYDNEY handles, nickel, patina
face plate for toilet door



ASTRA handle, nickel, satin
face plate



ASTRA handle, nickel, satin
face plate, economy



QUBIK handle, black
face plate



QUBIK handle, black
face plate for toilet door

Metal-Bud

PRODUCENT KLAMEK

HANDLES FOR PLATE, STILE LEAVES, WITH LONG FACE PLATE

The handle not to be used for panel door leaves with casing frames, see p. 158. (DOES NOT APPLY TO SYDNEY and QUBIK handles, long face plate).
The handles with a long face plate are not to be used for non-rebated doors (see p. 132)

METAL-BUD JOWISZ INOX handles, long face plate (10 mm thick) CERTIFIED FOR USE IN LEDA EI30 AND EI 60 FIRE AND FRONT DOORS

Metal-Bud
PRODUCENT KLAMEK

Stainless steel, investment



JOWISZ INOX handle
Key face plate



JOWISZ INOX handle
face plate for toilet door



JOWISZ INOX handle
face plate



JOWISZ INOX handle
face plate, economy

METAL-BUD TOPAZ INOX handle, long face plate (10 thick), spacing 72 mm

stainless steel



TOPAZ INOX handle
Key face plate



TOPAZ INOX handle
face plate for toilet door



TOPAZ INOX handle
face plate



TOPAZ INOX handle
face plate, economy

HANDLES FOR HERSE SET, HERSE LUX SET, HERSE MAX SET

handle METAL-BUD ERKADO BONN and ESSEN (face plate thickness ESSEN - 10 mm, BONN - 8 mm), spacing 72 mm



BONN handle and face plate



patina



black

BONN handle and face plate,
black



nickel satin

ESSEN handle and face plate



patina



black matt

LOCK CORES



lock core
colour: nickel satin



lock core with thumbturn
colour: nickel satin

Lock cores in the master key system 30/45 + 30G/45
Outwards opening doors

Lock cores in the master key system 30/45 + 30/45G
Inwards opening doors

LOCK CORE	LOCK CORE WITH THUMBTURN
Size	Size
26/36	G30/40
30/30	G40/30
30/40	G30/50
30/45	G50/30
30/50	30/45G
	30G/45



TECHNICAL INFORMATION

DOOR OPENING DIRECTIONS

SINGLE DOOR **LEFT DOOR LEAF**

SINGLE DOOR **RIGHT DOOR LEAF**

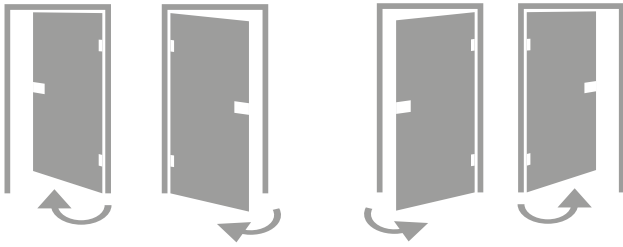

REBATED, NON-REBATED, REVERSE DOORS

OPENING DIRECTION

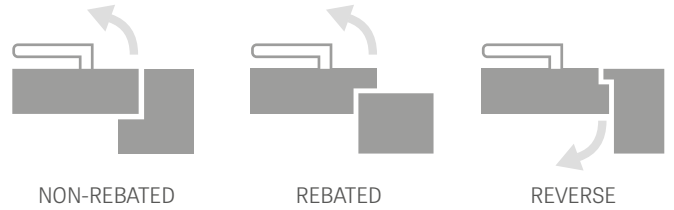

DOUBLE DOORS

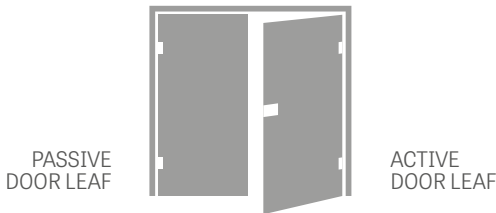

DOOR FRAME JOINTS

45°



90°



HOW TO SELECT A LOCK CORE

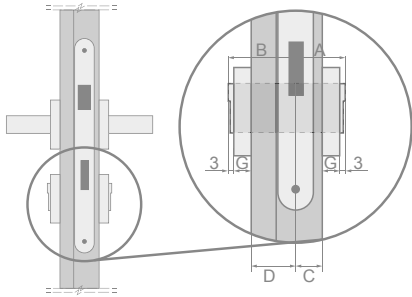

Example of calculating the lock core size for the flush and stile doors (40mm) with the face plate thickness of G = 7 mm

$$A/B = (C+G+3) / (D+G+3)$$

$$A/B = (15+7+3) / (25+7+3)$$

$$A/B = 25/35$$

Door type	Door leaf thickness	Proportion of lock setting in door (C/D)	Recommended lock core size (A/B)*
Flush, stile (rebated)	40 mm	15/25	26/36
Flush, stile (non-rebated)	40 mm	20/20	30/30
reverse	40 mm	15/25	26/36
HERSE	46 mm	15/31	30/45
LEDA EI 30	50 mm	19/31	30/40
LEDA EI 60	60 mm	19/41	30/50
FORTECA RC2 & RC3	46 mm	20/26	30/40
HYPERION EI30 RC2	50 mm	19/31	30/40

* Recommended lock core size for the escutcheon thickness of 7 mm and play of 2 mm to 4 mm

HOW TO CALCULATE DOOR PRICE

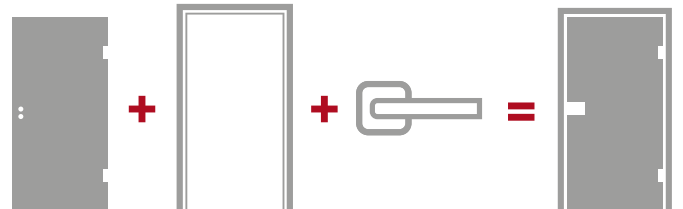

AVAILABLE SOLUTIONS (p. 135-143)

- wall-mounted sliding door systems, single-leaf



- wall-mounted sliding door systems, double-leaf

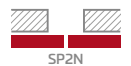

- pocket sliding door systems, single-leaf



- pocket sliding door systems, double-leaf

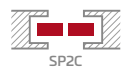

- supplementary system ZN1



- supplementary system ZN2



- double-leaf doors



DOOR FACE FINISH TYPES

FINISH

The Finish laminate is pre-impregnated, which means printing and then coating with paint with required properties. Using the performance finishing coats adds to the surface's basic resistance.

GREKO

The Greko laminate is also pre-impregnated, which means printing and then coating with paint with required properties. Using the performance finishing coats adds to the surface's resistance and flexibility of the product. The paint's silicon content ensures the film resistance is enhanced.

The Greko laminate is manufactured on a high density Japanese base layer which is not resin coated. This makes the film ecological, healthy and safe for people and environment both in the production process and during use, as well as for disposal. No formaldehyde or other harmful ingredients is used.

Its distinctive patterns are what distinguishes the Greko film. The laminates bear striking resemblance to wood, as the high quality surface comes with a 3D natural wood effect. Woodgrain decors look just like wood

PREMIUM

The Premium laminate is a product based on Polypropylene (PP), a material of very high resistance to abrasion and scratching, plus top quality appearance. It adds a refined looks and individual character to the doors, as it imitates natural wood perfectly.

Not only does the Premium laminate attracts with its appearance but with its functionality, as it resists scratching better than average products and is fire-retardant and abrasion resistant.

These properties ensure the extended longevity and maintenance-free use of the PREMIUM range products even in most adverse conditions.

ST CPL, CPL 0,2 and CPL 0,7

The CPL laminate is composed of a decorative layer impregnated in resins, and a base layer ensuring flexibility. Following the lamination process, the top resin layer is hardened for high resistance to scratching and abrasion. It is characterised by high resistance to impact, abrasion, scratching, heat and UV radiation

Thanks to using this type of material, the door can be installed in so-called "difficult" interiors [exposed to heat, moisture or extraordinary use]. Approx. laminate thickness: ST CPL - 0,15 mm , CPL 0,2 - 0,2 mm and CPL 0 CPL 0,7 - 0,7 mm. The CPL 0.7 laminate is used to cover only one leaf plane thanks to its unique hardness. The CPL 0,2 and CPL 0,7 laminated door leaves come with the leaf edge made of the so-called ABS, a highly durable PVC.

ST CPL laminate in decors white, light grey, cappuccino, black has been refined in the AntiFinger coating limiting dirt and fingerprints. **NEW**

UV VARNISH

The door surface has several coats of the WHITE TITANIUM UV modern UV hardened varnish.

The flat surfaces are covered with a specialist base membrane in the first phase, and then coated twice with a top quality paint and hardened with UV.

The moulded surfaces cannot be covered with the membrane for technological reasons, so they are coated with three paint layers and hardened with UV.

The fully automatic coating process follows scanning to ensure ideal quality of the surface. Hardening the paint with the cutting-edge method involving UV light source ensures very high mechanical resistance.

EDGE FINISH TYPES

EDGE SOFT



The SOFT door leaf comes with a chamfered edges, which lends an aesthetic and modern look to it. The leaf is finished with a laminate of an improved resistance to scratching, which dramatically enhances its resistance during use.

STANDARD EDGE



It involves covering the flat plane with the 0.15 mm ST CPL laminate, CPL 0.2 , CPL 0,7 laminates, polypropylene PREMIUM laminate, GREKO laminate or FINISH film.

The door leaf made in STANDARD technology has unchamfered edges, which is where the face panel is joined with edging laminate, as shown in the diagram. The laminate in the CPL 0.2 and CPL 0,7 laminates is made of very durable PVC, the so-called ABS. The joining method of the laminate is also identical for the non-rebated doors and non-rebated sliding systems.



¹⁾ applies only to BALDUR 1 in WHITE ST CPL laminate with solid core filling

STILE DOOR LEAF

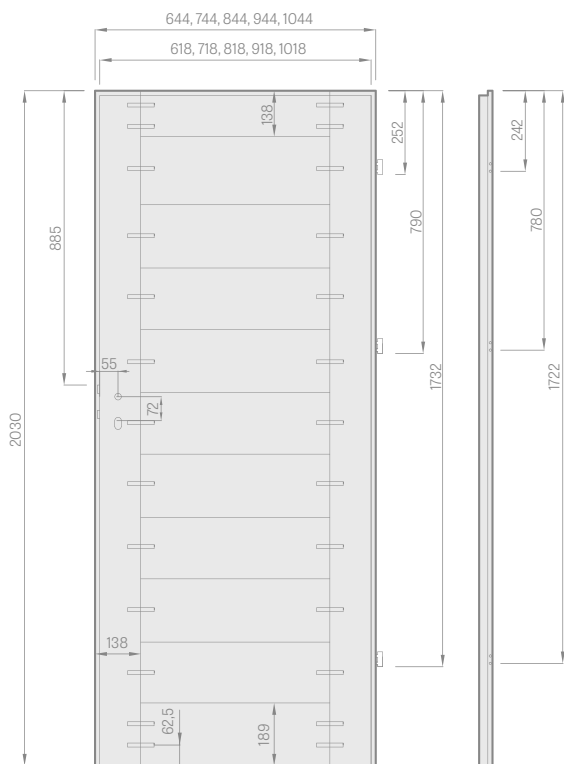

Rebated door leaf



- A** MDF or timber stiles in PREMIUM laminate
- B** MDF rails

PANEL DOOR LEAF

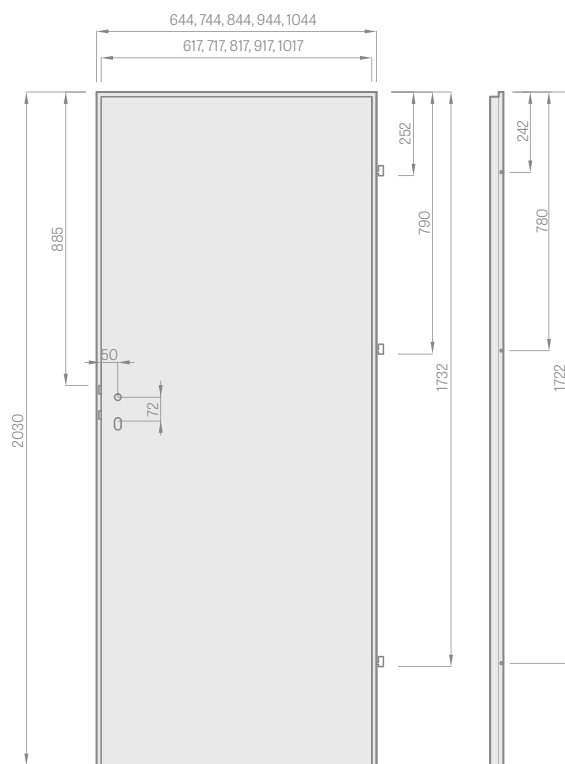

Rebated door leaf



- A** MDF board; **B** gasket; **C** HDF board; **D** filling;
- E** MDF or timber stiles in Herse SET and UNO PREMIUM



Solid 35 mm or 22 mm thick rail



Aesthetic frameless tongue-and-groove glazing without bars

FILLING TYPES

Honeycomb



solid core filling



MDF stile for the GREKO and CPL laminates with the AntiFinger coating **NEW**



Glulam timber stile for PREMIUM and CPL surfaces without the AntiFinger coating

Honeycomb and solid core filling in the panel doors ONLY. For the flush doors we add a third hinge as standard.

GRAF GLASS PANEL

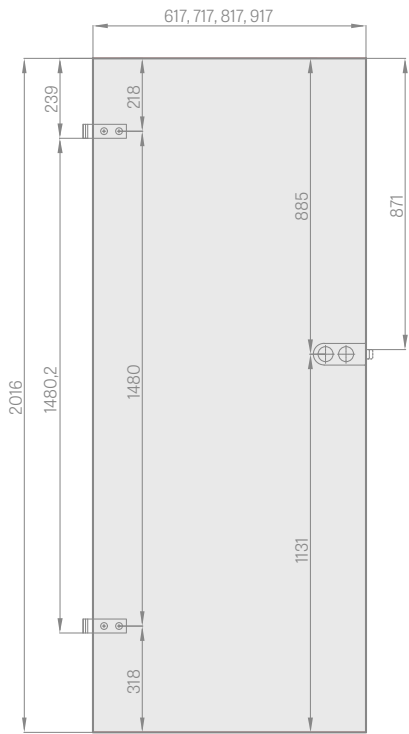

FIRE DOOR LEAF

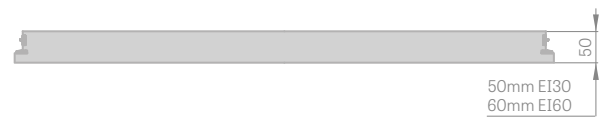
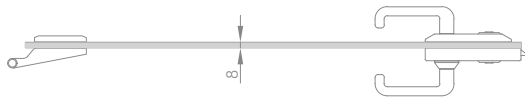
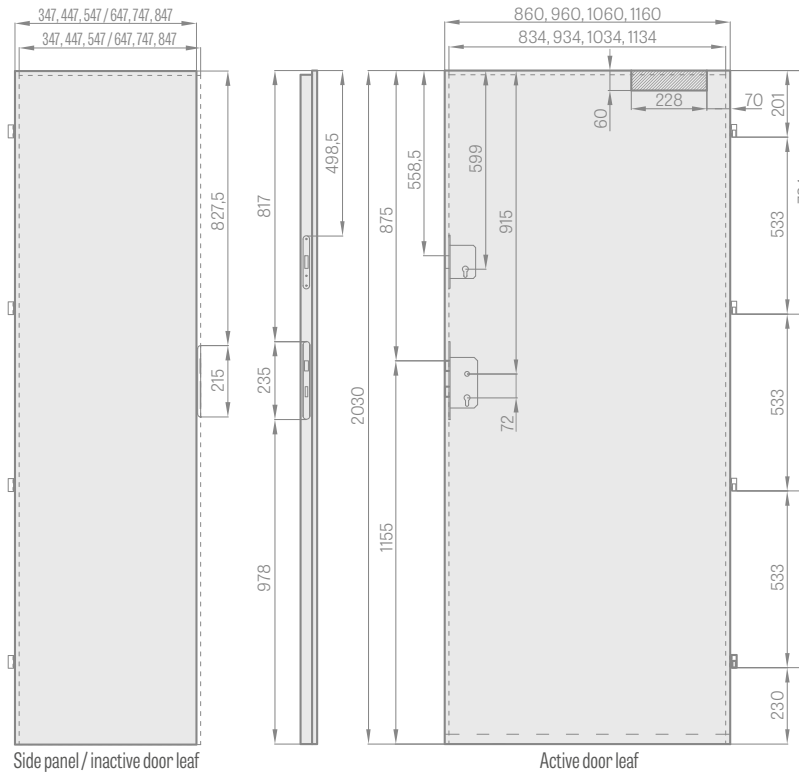

BATHROOM TURN & RELEASE

outside (Z)

inside (W)

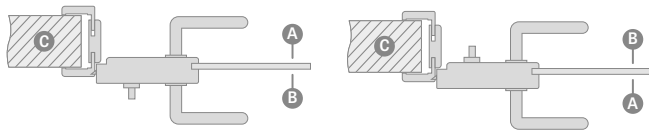

A Corridor; **B** Bathroom; **C** Wall

Bathroom lock – for turn and release locks, select:

OUTSIDE lock – with the bathroom turn and release is fitted to the outside of the door (Z)

or
INSIDE lock – with the bathroom turn and release is fitted to the inside of the door (W)

NOTE: Directions for the turn and release locks apply (R/L)

STANDARD OBVERSE GLAZING

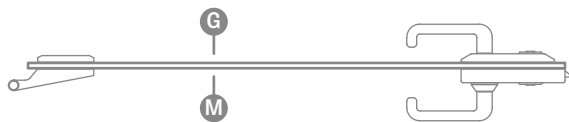

REVERSE GLAZING MADE TO ORDER:



G Plain side; **M** ornamented matt side;



Specially designed HALSPAN board filling 44 mm [EI30] / 54 mm [EI60]



Fire rated and smoke intumescent door gasket in red or black



Drop-down gasket with pressure adjustment by Allen key



Fixed door frame



Useful four hinges $\varnothing 16$ with 3D adjustment

CONCEALED MAGNETIC STOPS NEW



chrome glossy, chrome satin, brass glossy, colourless, white semi-matt, black semi-matt

We assemble the magnetic door stop in a special place milled for this purpose on our own.

Product delivered as a separate assortment.

Caution (important information in case of underfloor heating): the floor element should be placed in the Ø14mm hole, 45 mm deep.

METAL CAPS FOR HINGES



Brushed nickel, patina, glossy chrome, glossy brass, white matt and black matt

Available casings:

- for Herse/Forteca Ø16, length 47 mm in colours: brushed nickel, patina, chrome gloss, brass gloss, white and black
- Hyperion Leda Ø16, length 64 mm in colours: chrome matt, black
- for interior leaves Ø15, length 47 mm in colours: brushed nickel, patina, chrome gloss, brass gloss, white and black

VENTILATION



Plastic sleeves for FINISH colour group

Plastic woodgrain sleeves for STILE doors with GREKO, PREMIUM and CPL decors



Square and round metal sleeves



Grilles

VENTILATION

Ventilation door cut not available in non-rebated door leaves for wall-mounted and pocket sliding doors.

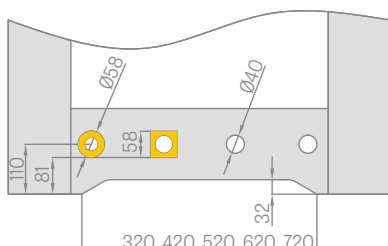

ELECTRIC DOOR STRIKE

(available for fixed and adjustable door frames for rebated doors, see p. 161-163, but unavailable for the door frames used with the GRAF glass panes and double-leaf doors)



Types of electric door strikes:

- basic 12 V
- basic 24 V
- switch operated 12 V
- switch operated 24 V
- reverse 12 V
- reverse 24 V

BASIC

SWITCH OPERATED

REVERSE

- normally closed, and opened when voltage is fed

- same operation as in the basic strike, but with an option to be switched off by moving the springbolt

- closed when voltage is fed, opened when not

The reverse and switch operated electric door strikes unavailable for the fire doors

CUTTING THE DOOR LEAVES

Cutting the door leaves to size by customer acc. to Polish standard, up to 50 mm, or up to 80 mm for the HERSE SET door leaves (unless pre-cut), as well as in the panel door leaves, is possible if an additional lower strip has been fitted by the manufacturer.

(NOTE: cutting the door leaves to size by customer is not allowed for the FRAGI doors, double-leaf and fire doors, non-rebated leaves for sliding systems, glass GRAF doors, FORTECA RC2 and FORTECA RC3 burglar-proof doors, and stile doors acc. to the CZ standard).

The door leaf height made acc. to the so-called CZ standard is lower than the PL standard by 47 mm.

Leaf type	Handle height (measured from the bottom edge of the leaf) [mm]
STILE rebated leaves	1107
STILE non-rebate door leaves	1110
rebated panel door leaves	1110
non-rebated panel leaves	1110
reverse panel door leaf	1110
Graf glass door leaves	1131
FORTECA RC2 & RC3 door leave	1038
Herse, Herse Akustic door leaf	1107
Herse door leaf with a strip lock	1033
Herse United door leaf	1117
Leda EI30, EI60 door leaf	1115
Hyperion EI30 RC2 door leaf	1033

HARDWARE - DEADBOLT LOCKS

KEY LOCK TOILET LOCK CYLINDER LOCK ECONOMY LOCK¹⁾

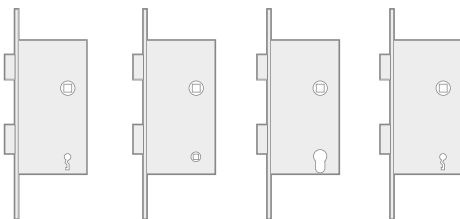

LOCK PZ CENTRES:

1. For rebated door leaves, the PZ centre of the key operated deadbolt lock, toilet lock and core lock is 72 mm.
2. For non-rebated and reverse door leaves, the PZ centre of the magnetic lock is:
 - key and toilet with 90 mm spacing
 - lock core spacing 85 mm

The toilet locks have a square-shaped bolt hole:

- acc. to PL standard: 4 mm
- acc. to CZ standard: 6 mm

¹⁾ lock provided without a keyhole in the leave

STANDARD "OBSERVE" GLAZING

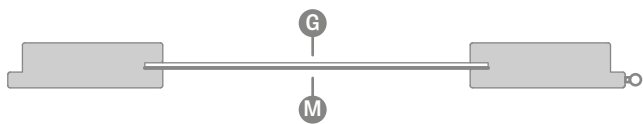

"REVERSE" GLAZING MADE TO ORDER

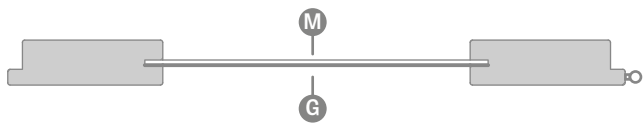

G plain side M matt side with decoration or colourless side with decoration

FROSTED and BLACK VSG 221, 331, 441 LAMINATED GLASS for STILE and panel doors

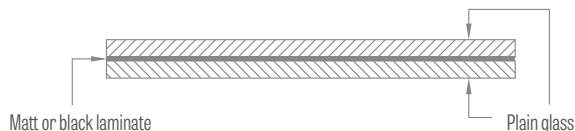

CLEARANCE UNDER DOOR LEAF AFTER INSTALLATION

Please check the lower clearance dimensions on all products prior to installation, as the allowable deviation due to frame dimensional tolerance is +/- 3mm

GLAZING TRANSLUCENCY ILLUSTRATION



GRAF 1 tempered, painted glass



GRAF 12 tempered, painted glass



GRAF 8 decormat



GRAF 9 transparent



GRAF 26 dark grey



GRAF 29 laminated glass



Tempered glass decormat frosted



Transparent tempered glass



Black VSG



Frosted VSG

FACTORY-DRILLED HANDLE OPENINGS NEW



Drilling of openings for the handle in stile doors in the PREMIUM and ST CPL decors for handles with a split face plate available in the Erkado offer.

NON-REBATED HARDWARE



concealed hinge



magnetic catch



adjustable magnetic catch strike

INSTALLATION OF FRAME FOR NON-REBATED DOOR FRAMES

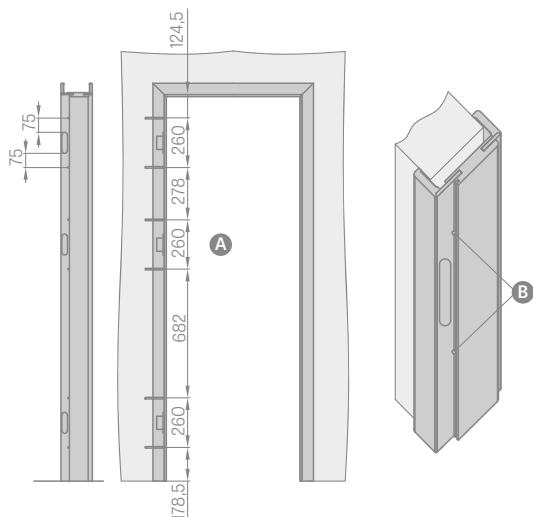

- A Drill holes for metal screws of min length 80 mm x Ø6 mm
- B Apart from installation foam, mounting anchors are required when installing the door frame.

Drill the holes for screws under the gasket so that it hides them.

CLEANING, REVITALISATION & REGENERATION KIT FOR OTTIMO DOORS





DOOR FRAME EXTENSION PANELS

WALL-MOUNTED

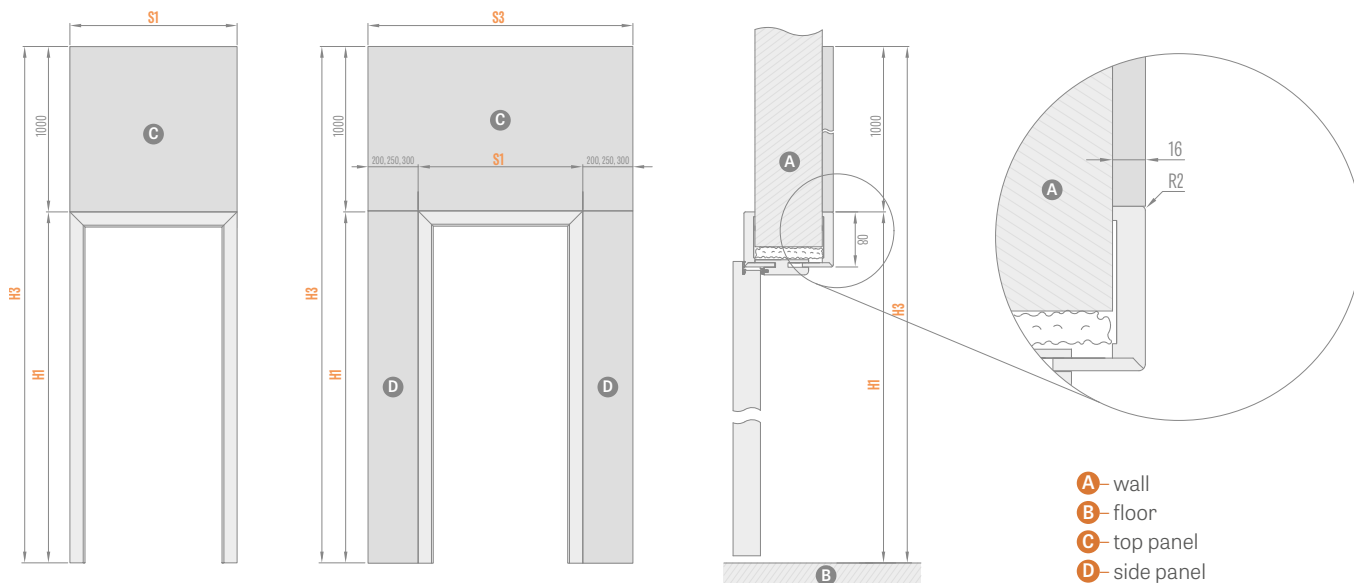

INTERNAL DOORS ¹⁾				
Frame type	H1	H3	Width	S1
Adjustable rebated door frame	2109	3109	"60"	786
			"70"	886
			"80"	986
			"90"	1086
			"100"	1186
Adjustable non-rebated door frame	2122	3122	"60"	811
			"70"	911
			"80"	1011
			"90"	1111
			"100"	1211
Reverse door frame (flush with the leaf)	2122	3122	"60"	791
			"70"	891
			"80"	991
			"90"	1091
			"100"	1191
REVERSE DOOR FRAME	2144	3144	"60"	834
			"70"	934
			"80"	1034
			"90"	1134
			"100"	1234

TOP PANEL (1000 x S1) ¹⁾

FRONT DOOR (panels on the staircase side door opening inwards)										
Frame type	H1	H3	Width	S1	S3					
Adjustable HERSE door frame	2109	3109	"80"	986	1186	1236	1286	1386	1486	1586
			"90"	1086	1286	1336	1386	1486	1586	1686
			"90E"	1090	1290	1340	1390	1490	1590	1690
			"100"	1186	1386	1436	1486	1586	1686	1786
			"80N"	1012	1212	1262	1312	1412	1512	1612
HERSE fixed door frame "clip-on"	2142	3142	"80"	1052	1252	1302	1352	1452	1552	1652
			"90"	1152	1352	1402	1452	1552	1652	1752
			"90E"	1156	1356	1406	1456	1556	1656	1756
			"100"	1252	1452	1502	1552	1652	1762	1852
			"80N"	1012	1212	1262	1312	1412	1512	1612
FORTECA fixed door frame "clip-on"	2147	3147	"80"	1056	1256	1306	1356	1456	1556	1656
			"90E"	1156	1356	1406	1456	1556	1656	1756
			"100"	1256	1456	1506	1556	1656	1756	1856
FORTECA adjustable fixed frame (installation side)	2136	3136	"80N"	990	1190	1240	1290	1390	1490	1590
			"80"	1034	1234	1284	1334	1434	1534	1634
			"90E"	1134	1334	1384	1434	1534	1634	1734
LEDA, HYPERION fixed door frame "clip-on"	2147	3147	"80"	1085	1285	1335	1385	1485	1585	1685
			"90E"	1185	1385	1435	1485	1585	1685	1785
			"100"	1285	1485	1535	1585	1685	1785	1885
LEDA, HYPERION adjustable fixed frame (installation side)	2136	3136	"80"	1063	1263	1313	1363	1463	1563	1663
			"90E"	1163	1363	1413	1463	1563	1663	1763
			"100"	1263	1463	1513	1563	1663	1763	1863

DOOR FRAME EXTENSION PANELS ²⁾
FINISH / GREKO
CPL0,2, ST CPL and PREMIUM
PAINTED

PANEL 200	PANEL 250	PANEL 300	2 x PANEL 200	2 x PANEL 250	2 x PANEL 300
SINGLE-FACE SIDE PANEL			DOUBLE-FACE SIDE PANEL		

¹⁾ only top panels are available for interior door frames



²⁾ the panels shall be edged on all four edges in a colour similar to that of the panel surface. The area is calculated from the tables above.



SLIDING SYSTEMS

WALL-MOUNTED

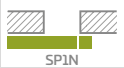
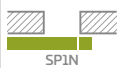
WALL-MOUNTED SLIDING DOOR SYSTEM:

SINGLE SP1Nz (with bolt keeper)	
SINGLE SP1Nb (w/o bolt keeper)	
DOUBLE SP2N	

Price includes:

Aluminium track with a cover profile and door stop in the colour of the door leaf and length:

- 210 cm for "100" leaves
- 200 cm for "90" leaves
- 180 cm for "80" leaves
- 150 cm for "70" "60" leaves

Available wall-mounted sliding system sets

- Track with a cover profile and door stop with gasket (only SP1Nz & SP1Nb)
- Track with a cover profile and tunnel door frame (only for SP2N)
- Track with a cover profile and door stop + tunnel door frame (only SP1Nz & SP1Nb)
- Track with a cover profile and door stop with gasket + tunnel door frame (only SP1Nz & SP1Nb)

The non-rebated door leaf for wall-mounted sliding system cannot be cut to size.

The cover profile is neither laminated nor paint coated on the inside.

EXTRA CHARGES

tunnel type adjustable door frame for the price of the adjustable door frame

hook bolt lock with hardware

only for the single system

oval, rectangular or **round** pull handle; glossy chrome, brushed chrome, glossy brass, black matt; two pcs. of pull handles per set

synchronisation

simultaneous opening and closing of the door leaves using only one leaf; only for SP2N

soft closing damper

automatic leaf damping during the final closing phase only for SP1Nz and SP1Nb

ROUND, OVAL AND RECTANGULAR PULL HANDLES

Glossy chrome, brushed chrome, glossy brass, black matt



HOOK BOLT KEY LOCKS

Glossy chrome, brushed chrome, glossy brass, black matt

Key only in silver



The hook bolt key lock comes with two pull handles to choose



WALL-MOUNTED SLIDING DOOR SYSTEM

WITH DOOR OPENING HOUSING

SP1Nz or SP1Nb (left, obverse version)

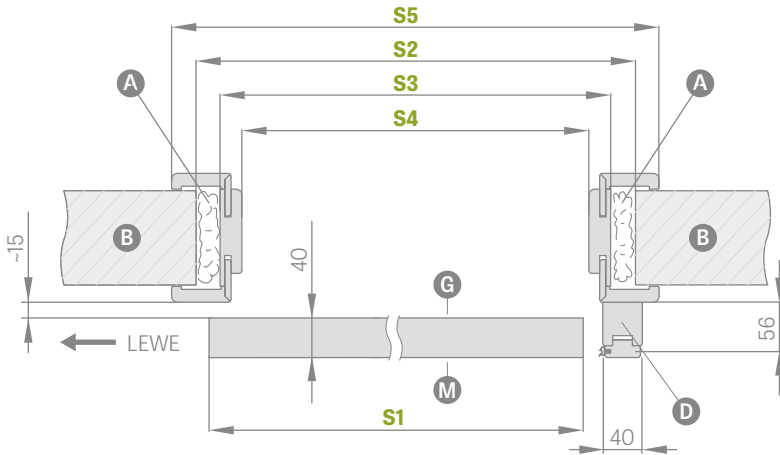

SP2N (obverse version)

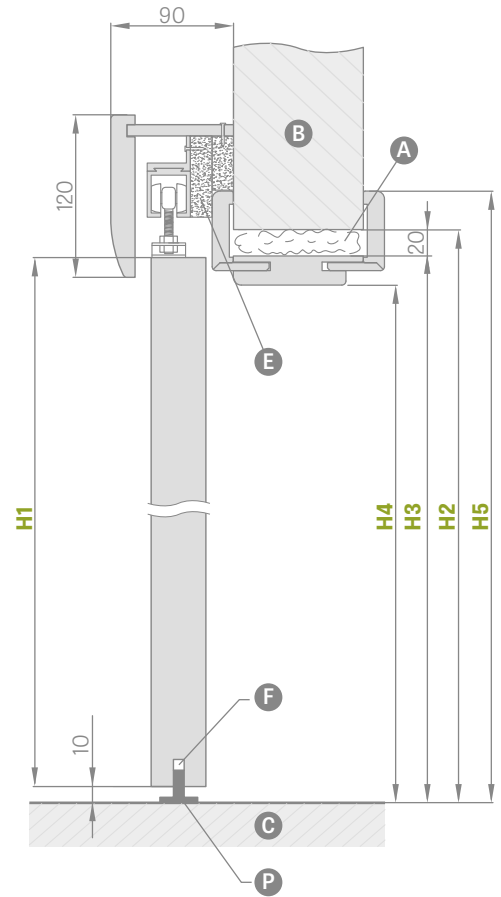
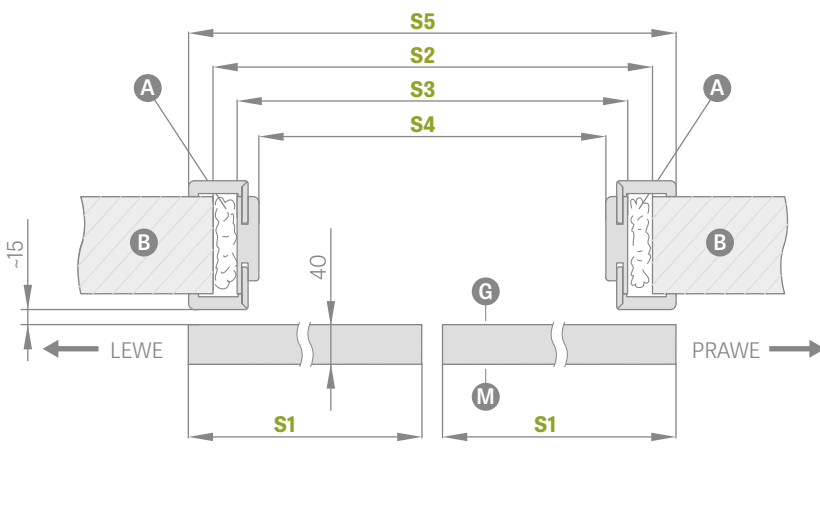

- A** – foam
- C** – floor
- E** – spacer strip
- G** – glass plain side
- M** – glass matt side

- B** – wall
- D** – door stop
- F** – moulding for guide rail
- P** – floor guide rail

WALL-MOUNTED SLIDING DOOR SYSTEM WITH DOOR OPENING HOUSING

	SINGLE-LEAF DOORS					DOUBLE-LEAF DOORS				
	"60"	"70"	"80"	"90"	"100"	"60" x 2	"70" x 2	"80" x 2	"90" x 2	"100" x 2
S1 Door leaf width	644	744	844	944	1044	1288	1488	1688	1888	2088
S2 Opening width in the wall	688	788	888	988	1088	1288	1488	1688	1888	2088
S3 Frame outer width	648	748	848	948	1048	1248	1448	1648	1848	2048
S4 Frame opening width	604	704	804	904	1004	1204	1404	1604	1804	2004
S5 Frame cover width architrave 6 cm/ architrave 8cm	746/786	846 /886	946 /986	1046 /1086	1146 /1186	1346 /1386	1546 /1586	1746 /1786	1946 /1986	2146/ none
H1 Door leaf height	2030	2030	2030	2030	2030	2030	2030	2030	2030	2030
H2 Opening height in the wall	2060	2060	2060	2060	2060	2060	2060	2060	2060	2060
H2 Opening height in the wall for SPN w/o housing	2020	2020	2020	2020	2020	2020	2020	2020	2020	2020
H3 Frame outer height	2040	2040	2040	2040	2040	2040	2040	2040	2040	2040
H4 Frame opening height	2018	2018	2018	2018	2018	2018	2018	2018	2018	2018
H5 Frame cover width architrave 6 cm/ architrave 8cm	2089 /2109	2089 /2109	2089 /2109	2089 /2109	2089 /2109	2089 /2109	2089 /2109	2089 /2109	2089 /2109	2089/ none



WALL-MOUNTED SLIDING DOOR SYSTEM

LOFT STANDARD TYPE



Leaf BALDUR 7, decor WHITE TITAN UV, black rectangular pull handle, brackets INDUSTRIAL

The LOFT STANDARD single sliding system is available with all leaves in the SP1N standard wall mounted sliding system.

Double sliding system LOFT STANDARD consists of two single systems and a connecting element for rails.

Double LOFT STANDARD system is counted as 2 x single system + connecting element for rails. Choice of two brackets holding the leaf: INDUSTRIAL and RETRO (page 138).

LOFT STANDARD sliding door system

oval, rectangular or round pull handle

door closer on one side

connector for tracks (enables the use of the LOFT system in the double-leaf system)

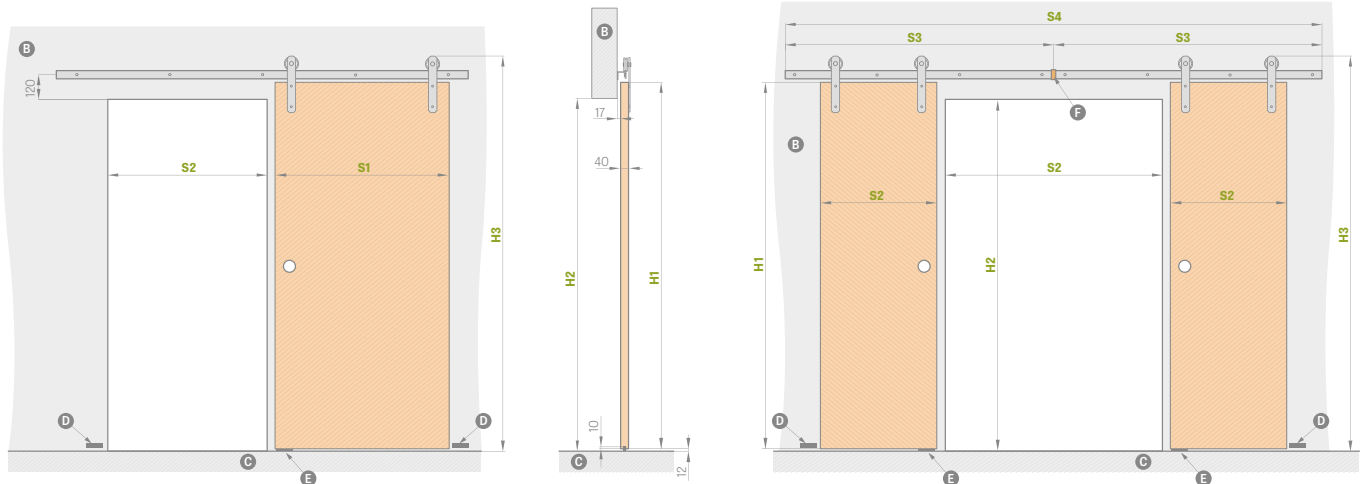

	"60"	"70"	"80"	"90"	"100"
S1 Door leaf width	644	744	844	944	1044
S2 Opening width in the wall ¹⁾	574	674	774	874	974
H1 Door leaf height	2030	2030	2030	2030	2030
H2 Opening height in the wall	1962	1962	1962	1962	1962
H3 Overall system height	2170	2170	2170	2170	2170

	"120"	"140"	"160"	"180"	"200"
S1 Door leaf width	2 x 644	2 x 744	2 x 844	2 x 944	2 x 1044
S2 Opening width in the wall ¹⁾	1202	1402	1602	1802	2002
S3 Guide width	1500	1500	2000	2000	2200
S4 Total guide width ²⁾	3000	3000	4000	4000	4400
H1 Door leaf height	2030	2030	2030	2030	2030
H2 Opening height in the wall	1962	1962	1962	1962	1962
H3 Overall system height	2170	2170	2170	2170	2170

GUIDE RAIL FOR SINGLE SYSTEM LENGTH:

- 200 cm for "60" "70" "80" leaves

- 250 cm for "90" "100" leaves

B – wall **C** – floor **D** – wall mounted buffer
E – guide **F** – guide connector ²⁾

¹⁾ the leaf in the closed position overlaps 35 mm on each side

²⁾ a guide for double-leaf system consists of two guides connected with a connector



WALL-MOUNTED SLIDING DOOR SYSTEM

LOFT Type

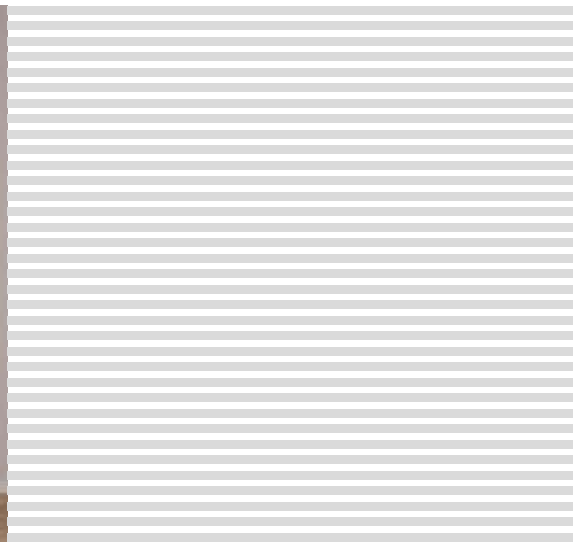

LOFT, decor OAK ST CPL, round pull handle, RETRO leaf bracket

LOFT Type wall-mounted sliding door system is available in black and comes complete with the LOFT Type plain door leaf. The LOFT door leaf comes with the stabilising "honeycomb" filling as standard or solid core for extra charge. The door leaf features a non-rebated edge. The system is designed for clear finished opening, without a tunnel.

The complete system includes the sliding LOFT system + LOFT door leaf + pull handle + door closer on one or both side(s).

The double LOFT system is counted as 2 x single system + connecting rail element.

Choice of two brackets holding the leaf: INDUSTRIAL and RETRO.

LOFT sliding door system

oval, rectangular or round pull handle

solid core filling

round and square metal ventilation sleeves (4 pieces); black matt

door closer on one side

connector for tracks (enables the use of the LOFT system in the double-leaf system)

black door leaf edge finish

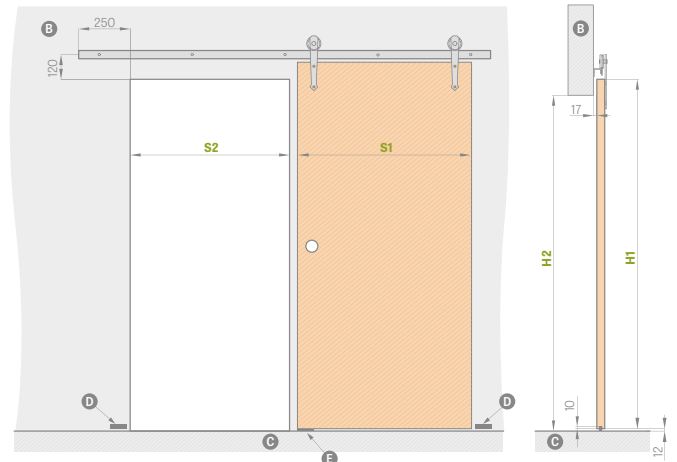

	"60"	"70"	"80"	"90"	"100"
S1 Door leaf width	644	744	844	944	1044
S2 Opening width in the wall	574	674	774	874	974
H1 Door leaf height	2150	2150	2150	2150	2150
H2 Opening height in the wall	2082	2082	2082	2082	2082

B – wall **C** – floor **D** – wall-mounted buffer **E** – guide

PREMIUM / CPL	CPL 0.2	WHITE TITANIUM UV PAINT
WALNUT PREMIUM	GREY MAPLE PREMIUM	OAK PREMIUM
CONCRETE PREMIUM	WHITE PREMIUM ¹⁾	WHITE TITANIUM UV
OAK ST CPL	GREY OAK ST CPL	VENGE ST CPL
CAPPUCINO ST CPL ²⁾	LIGHT-GREY ST CPL ²⁾	BLACK ST CPL ²⁾
WHITE CPL 0.2	ASH GREY CPL 0.2	ANTHRACITE CPL 0.2
		OAK CPL 0.2
		WHITE BARK PREMIUM
		NATUR OAK PREMIUM
		GREY PINE ST CPL
		NATUR OAK PREMIUM HORIZONTAL ³⁾

¹⁾ plain white laminate imitating a painted surface

²⁾ special **AntiFinger** **NEW** coating to reduce dirt and fingerprints

³⁾ available as of 01/04/2022

ROUND, OVAL, RECTANGULAR PULL HANDLES

glossy chrome, brushed chrome, glossy brass, black matt



GUIDE RAIL LENGTHS:

- 200 cm for "60" "70" "80" leaves
- 250 cm for "90" "100" leaves

LEAF-HOLDING BRACKETS





WALL-MOUNTED SLIDING DOOR SYSTEM

MAGIC Type



MAGIC leaf, decor OAK PREMIUM, oval pull handle

MAGIC Type wall-mounted sliding door system is available complete with the MAGIC Type plain door leaf only. The MAGIC door leaf comes with the stabilising "honeycomb" filling as standard or solid core for extra charge. The door leaf features a non-rebated edge. The system is designed for clear finished opening, without a tunnel.

The complete system includes the sliding MAGIC system + MAGIC door leaf + pull handle. The system is only available as a complete set (system + leaf).

MAGIC SLIDING DOOR SYSTEM

oval, rectangular or round pull handle

solid core filling

round and square metal sleeves (4 pcs);
glossy chrome, brushed chrome, black matt

black door leaf edge finish

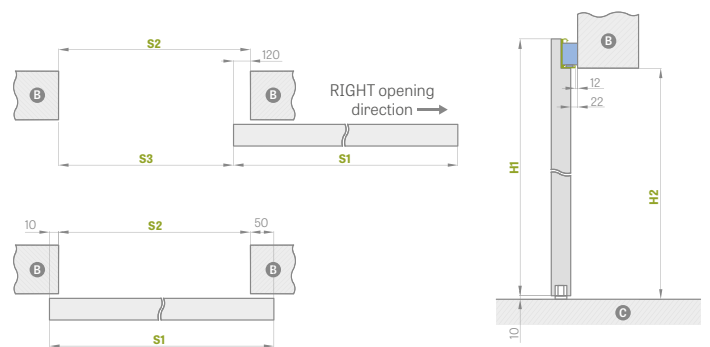

MAGIC WALL-MOUNTED SLIDING DOOR SYSTEM

		"60"	"70"	"80"	"90"	"100"
S1	Door leaf width	644	744	844	944	1044
S2	Opening width in the wall	584	684	784	884	984
S3	Transition light	464	564	664	764	864
H1	Door leaf height	2150	2150	2150	2150	2150
H2	Opening height in the wall	2100	2100	2100	2100	2100

B – wall C – floor

PREMIUM / CPL	CPL 0.2	WHITE TITANIUM UV PAINT
---------------	---------	-------------------------

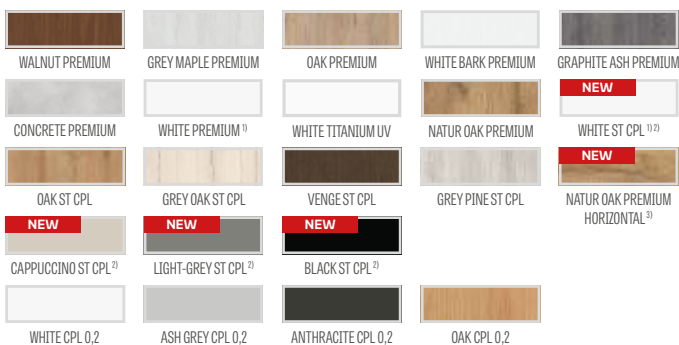

ROUND, OVAL, RECTANGULAR PULL HANDLES

Glossy chrome, brushed chrome, glossy brass, black matt



BLACK PLAIN DOOR LEAF EDGE FINISH



BLACK TRANSVERSE DOOR LEAF EDGE FINISH

¹⁾ plain white laminate imitating a painted surface

²⁾ special **AntiFinger** **NEW** coating to reduce dirt and fingerprints

³⁾ available as of 01/04/2022



WALL-MOUNTED SLIDING DOOR SYSTEM

GRAF GLASS DOORS



GRAF 38 SYSTEM

Sliding system for glass doors with a silver anodised aluminium or back matt powder-painted cover.

This system is complete and designed for fitting in a clear finished opening, as the tunnel is not available. The system range includes all GRAF glass panes, see p. 58/-59 and go to our website: www.erkado.pl and the B2B panel.

The complete system includes: sliding SYSTEM GRAF + glass pane SYSTEM GRAF + pull handle + door closer on one side

GLASS DOOR SLIDING SYSTEM

- silver anode
- black matt

glass pane

double-sided round pull handle, stainless steel

double-sided round pull handle, stainless steel, black matt

"90" glass pane extra charge

door closer

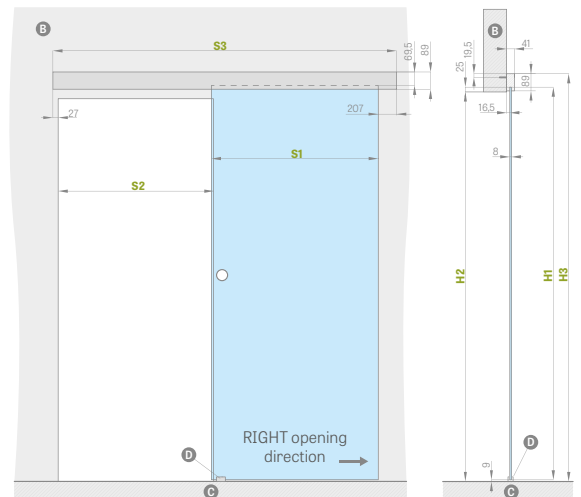

WALL-MOUNTED GLASS DOOR SLIDING SYSTEM					
	"60"	"70"	"80"	"90"	
S1	Door leaf width	662	762	862	962
S2	Opening width in the wall	602	702	802	902
S3	Guide rail length	1500	1500	1800	2000
H1	Door leaf height	2036			
H2	Opening height in the wall	max 2020			
H3	Overall system height	2114			

PULL HANDLE

stainless steel, matt black







B – Wall **C** – Floor **D** – Guide shoe

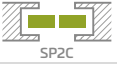

SLIDING SYSTEMS

POCKET SYSTEMS

ERKADO pocket door system range includes:

BASIC TUNNEL INSTALLATION		
SP1C.100		Single "100" pocket sliding system only available for STILE doors, painted doors and ALTAMURA 1, UNO PREMIUM and UNO LUX models
SP2C.100		Double "100" pocket sliding system only available for STILE doors and ALTAMURA 1 and UNO PREMIUM models
SP1C.125		Single "125" pocket sliding system
SP2C.125		Double "125" pocket sliding system
ZN1		One-sided supplementary basic in-wall installation for SP1C.100 or SP1C.125 system
ZN2		One-sided supplementary basic in-wall installation for SP2C.100 or SP2C.125 system

Not available for CPL0.2 & CPL0.7 laminates

$$\text{SLIDING SYSTEM PRICE} = \text{DOOR LEAF PRICE} + \text{ALUMINIUM POCKET PRICE} + \text{BASIC TUNNEL INSTALLATION PRICE} + \text{OPTIONAL INSTALLATION PRICE ZN1 OR ZN2}$$

Standard single/double pocket sliding system includes:

- Aluminium case [LEON] SP1
- Aluminium case [LEON] SP2
- Non-rebated door leaf / two non-rebated door leaves – price for standard door leaf / price for two door leaves
- basic tunnel installation (see table above)
- tunnel installation ZN1 or ZN 2 – see table on the next page

ROUND, OVAL AND RECTANGULAR PULL HANDLES

Glossy chrome, brushed chrome, glossy brass, black matt



HOOK BOLT KEY LOCKS

Glossy chrome, brushed chrome, glossy brass, black matt



Key only in silver

The hook bolt key lock comes with two pull handles to choose

EXTRA CHARGES

frame joints at 90 degrees

Hook bolt lock with hardware

Only available for: SP1C.100, SP1C.125

oval, rectangular or round pull handle

glossy chrome, brushed chrome, glossy brass, black matt

Available for SP1C.100, SP2C.100, SP1C.125, SP2C.125

Pull handle set includes two pcs.

finger pull

glossy chrome, brushed chrome, glossy brass, black matt

synchronisation

simultaneous opening and closing of the door leaves using only one leaf

only available for: SP2C.100, SP2C.125

soft closing damper

Automatic soft close in the final closing phase; available for SP1C.100, SP1C.125 only

IN-WALL INSTALLATION IN THE SINGLE LEAF SYSTEM FOR ONE SIDE ZN1

One-sided adjustment range for the basic wall min-max (mm)

0-40; 40-60; 60-80;
80-100; 100-120; 120-140
140-160; 160-180; 180-200
200-220; 220-240
240-260; 260-280
280-300; 300-320
320-340; 340-360

- The system of one-sided in-wall installation for double doors ZN2 + 30% extra of the prices in table above

SINGLE SLIDING SYSTEMS AND DOUBLE POCKET SYSTEMS

		"60"	"70"	"80"	"90"	"100"	2 x "60"	2 x "70"	2 x "80"	2 x "90"	2 x "100"
S1	Door leaf width	644	744	844	944	1044	1288	1488	1688	1888	2088
S2	Frame opening width	602	702	802	902	1002	1202	1402	1602	1802	2002
S3	Pocket width	1318	1518	1718	1918	2118	2538	2938	3338	3738	4138
S4	Frame cover width architrave 6cm/ architrave 8cm	744/784	844/884	944/984	1044/ /1084	1144/1184	1344/ /1384	1544/ /1584	1744/1784	1944/ /1984	2144/none
S5	Opening width in the pocket	655	755	855	955	1055	1255	1455	1655	1855	2055
S6	Opening width in the wall	1338	1538	1738	1938	2138	2558	2958	3358	3758	4158
H1	Door leaf height	2030	2030	2030	2030	2030	2030	2030	2030	2030	2030
H2	Frame cover width architrave 6cm/ architrave 8cm	2092 /2112	2092 /2112	2092 /2112	2092 /2112	2092 /2112	2092 /2112	2092 /2112	2092 /2112	2092 /2112	2092/ none
H3	Pocket height	2115	2115	2115	2115	2115	2115	2115	2115	2115	2115
H4	Frame opening height	2021	2021	2021	2021	2021	2021	2021	2021	2021	2021
H5	Opening height in the wall	2125	2125	2125	2125	2125	2125	2125	2125	2125	2115



Photo: Wall-mounted sliding system



Photo: Pocket sliding system



SINGLE AND DOUBLE SYSTEMS

POCKET SYSTEMS

SP1C.100 (left, AWERS obverse glazing)

Fixed range of 100 mm

Pocket thickness before gypsum board installation – 75 mm

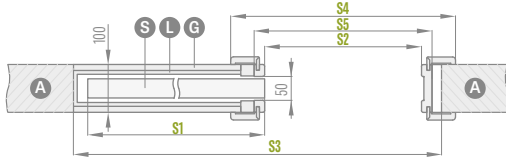

For UNO PREMIUM, ALTAMURA 1 only, and for all stile door leaves. The system does not come with dust brushes (not required).

SP1C.125 (left, AWERS obverse glazing)

Fixed range of 125 mm

Pocket thickness before gypsum board installation – 100 mm

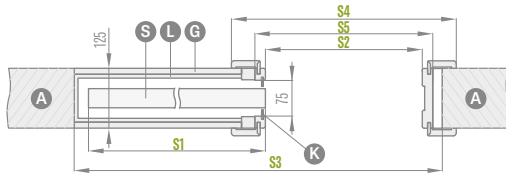

Only for use with panel door leaves which are supplied with a glass frame. The system includes grey dust brushes.

ZN1 one-sided basic in-wall installation for SP1C.100 and SP1C.125

basic in-wall installation range from 0-40; 40-60; ... 340-360

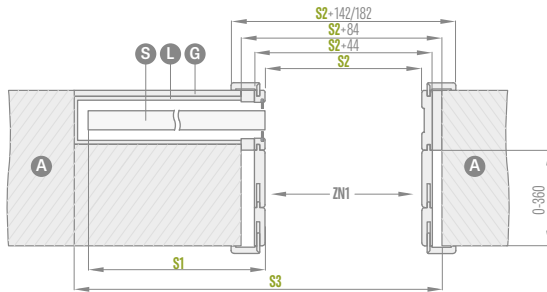

The drawing shows a one-sided the basic in-wall installation ZN1.

SP2C.100 (AWERS obverse glazing)

Fixed range of 100 mm

Pocket thickness before gypsum board installation – 75 mm

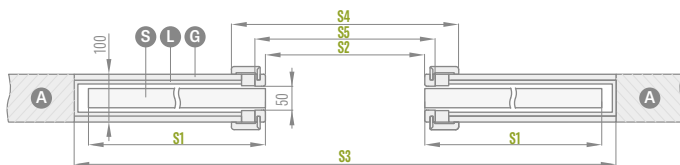

For UNO PREMIUM, ALTAMURA 1 only, and for all stile door leaves. The system does not come with dust brushes (not required).

SP2C.125 (AWERS obverse glazing)

Fixed range of 125 mm

Pocket thickness before gypsum board installation – 100 mm

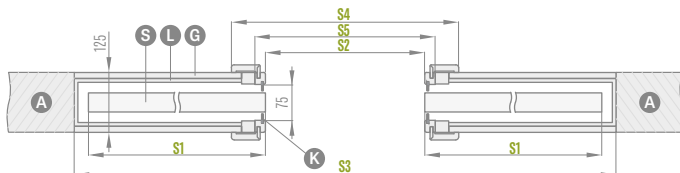

Only for use with panel door leaves which are supplied with a glass frame. The system includes grey dust brushes.

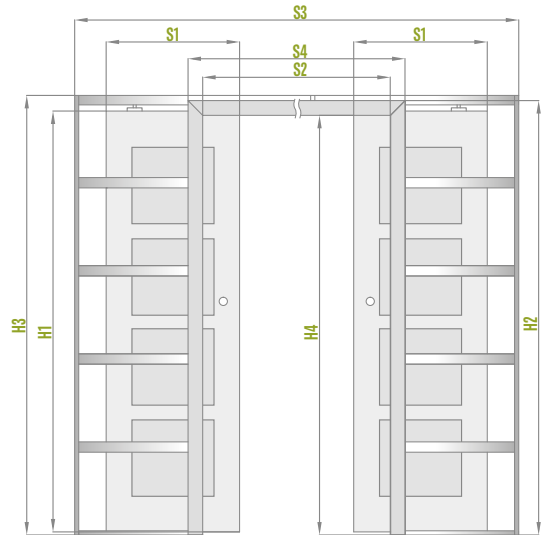
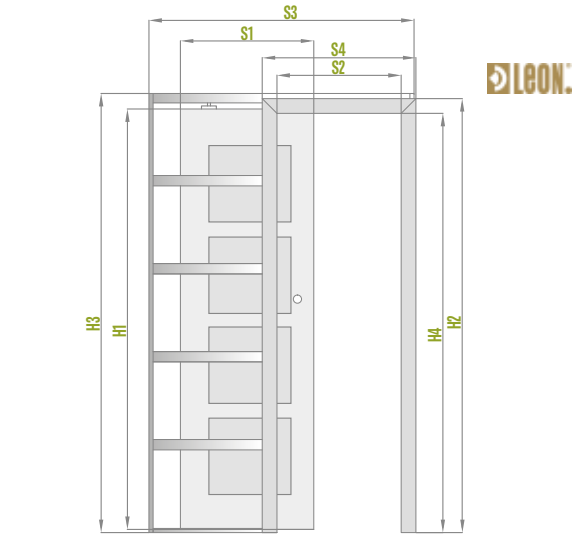

- A – wall
- G – gypsum board
- S – leaf

- L – aluminium case
- K – dust brushes

ZN2 one-sided basic in-wall installation for SP2C.100 and SP2C.125

basic in-wall installation range from 0-40; 40-60; ... 340-360

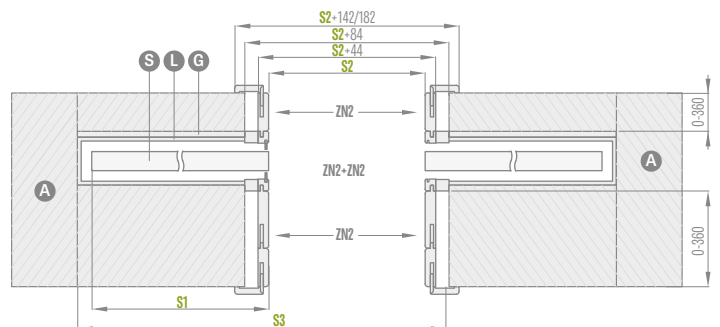

The drawing shows double-sided the basic in-wall installation ZN2 + ZN2.



DOUBLE-LEAF DOORS

REBATED AND NON-REBATED

USEFUL INFORMATION

DOUBLE-LEAF DOORS



- The double-leaf doors are supplied with a solid core filling for extra charge.
- The double-leaf doors are made according to available models of the flush single leaf doors, STILE doors with respective features: colour, finish (STANDARD, SOFT), glazing etc.
- Double-leaf doors available in CPL 0.2 & CPL 0.7
- Passive doors use pull latches.
- Under "60" width passive door available in the full plain version only – side panel (see drawing below).
- Side panels are made in the STANDARD edge flush technology. Available with the "honeycomb" filling as standard or solid core for extra charge. Grain direction of the side panels is vertical.
- Both active and inactive door leaves come with lippings.
- Lippings in CPL 0.7 door leaves are laminated with CPL 0.2
- The double-leaf doors in non-rebated technology is available with a magnetic lock only.
- Double non-rebated leaf doors come with an adjustable door frame only.
- Electric door strike is not available for the double-leaf doors.

AVAILABLE DOOR LEAF WIDTHS

- Panel and stile DOUBLE-LEAF DOORS from "120" to "190"*** and mixes with full plain side panels

60 + 30*	70 + 30*	80 + 30*	90 + 30*	100 + 30*
60 + 40*	70 + 40*	80 + 40*	90 + 40*	100 + 40*
60 + 50*	70 + 50*	80 + 50*	90 + 50*	100 + 50*

- * Side panel available in standard technology only as a full plain version
- ** For "180" non-rebated doors

DOUBLE-LEAF DOOR PRICE:

- Panel and stile:

active leaf **60 70 80 90 100** + passive leaf **60 70 80 90***

$$\text{price of double-leaf doors with lipping} = \text{Door leaf price x 2} + \text{Lippings}$$

- Panel and stile:

active leaf **60 70 80 90 100** + full, plain passive side panels **30 40 50**

$$\text{price of double-leaf doors with side panel and lipping} = \text{Door leaf price} + \text{Full side panel with lippings}$$

- Prices of fixed and adjustable door frames for double-leaf doors + 30%
- Extra charge for solid core in the extension
- Painted extension only solid core WHITE TITANIUM UV

* not in the non-rebated door leaves



DOUBLE-LEAF DOORS

NON-REBATED

NON-REBATED DOUBLE-LEAF DOORS WITH ADJUSTABLE DOOR FRAME

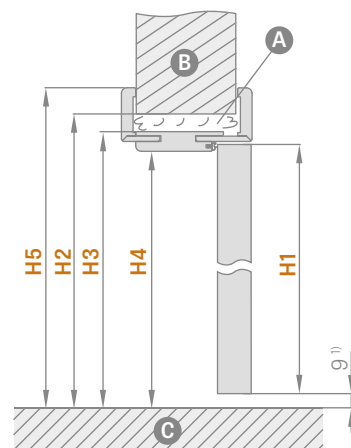
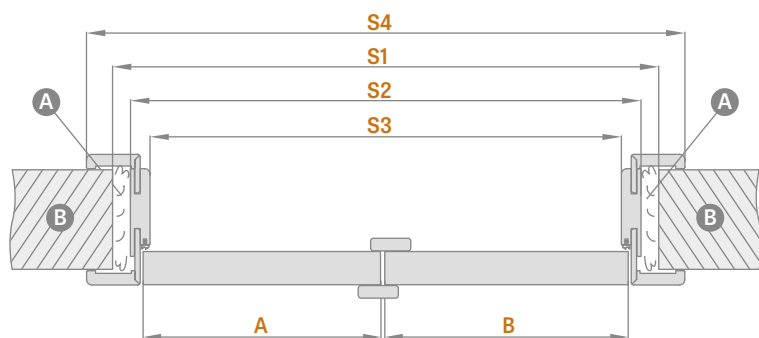

A - foam B - wall C - floor

¹⁾ allowable deviation due to frame dimensional tolerance of $\pm 3\text{mm}$ (we recommend to check before installation)

Adjustable door frame		NON-REBATED DOUBLE-LEAF DOORS									
		"90"	"100"	"110"	"120"	"130"	"140"	"150"	"160"	"170"	"180"
A+B	Door leaf width	988	1088	1188	1288	1388	1488	1588	1688	1788	1888
S1	Opening width in the wall	1061	1161	1261	1361	1461	1561	1661	1761	1861	1961
S2	Frame outer width	1021	1121	1221	1321	1421	1521	1621	1721	1821	1921
S3	Frame opening width	977	1077	1177	1277	1377	1477	1577	1677	1777	1877
S4	Frame cover width architrave 6 cm/ architrave 8 cm	1119 / 1159	1219 / 1259	1319 / 1359	1419 / 1459	1519 / 1559	1619 / 1659	1719 / 1759	1819 / 1859	1919 / 1959	2019 / 2059
H1	Door leaf height	2030	2030	2030	2030	2030	2030	2030	2030	2030	2030
H2	Opening height in the wall	2073	2073	2073	2073	2073	2073	2073	2073	2073	2073
H3	Frame outer height	2053	2053	2053	2053	2053	2053	2053	2053	2053	2053
H4	Frame opening height	2031	2031	2031	2031	2031	2031	2031	2031	2031	2031
H5	Frame cover width architrave 6 cm/ architrave 8 cm	2102 / 2122	2102 / 2122	2102 / 2122	2102 / 2122	2102 / 2122	2102 / 2122	2102 / 2122	2102 / 2122	2102 / 2122	2102 / 2122

DOUBLE-LEAF DOORS
- SYMMETRIC



DOUBLE-LEAF DOORS
- ASYMMETRIC



DOUBLE-LEAF DOORS
- WITH PLAIN SIDE PANEL





DOUBLE-LEAF DOORS

REBATED

REBATED DOUBLE-LEAF DOORS WITH ADJUSTABLE DOOR FRAME

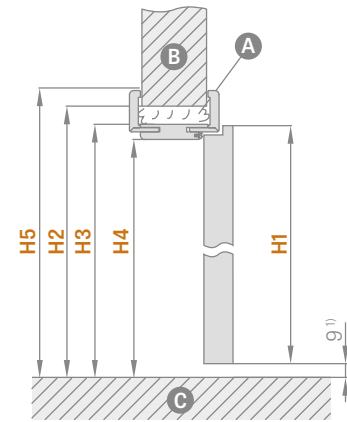
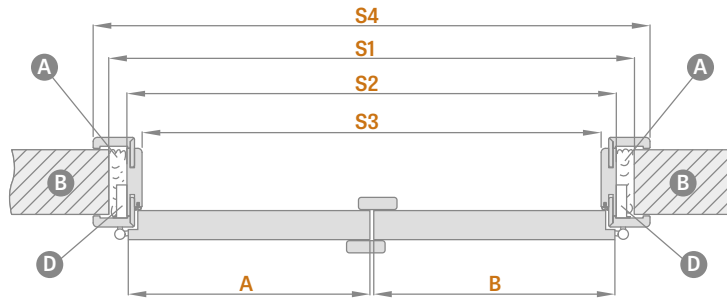

A-foam B-wall C-floor D-hinge seat

Adjustable door frame		DOUBLE-LEAF DOORS										
		"90"	"100"	"110"	"120"	"130"	"140"	"150"	"160"	"170"	"180"	"190"
A+B	Door leaf width	988	1088	1188	1288	1388	1488	1588	1688	1788	1888	1988
S1	Opening width in the wall	1034	1134	1234	1334	1434	1534	1634	1734	1834	1934	2034
S2	Frame outer width	994	1094	1194	1294	1394	1494	1594	1694	1794	1894	1994
S3	Frame opening width	950	1050	1150	1250	1350	1450	1550	1650	1750	1850	1950
S4	Frame cover width architrave 6 cm/ architrave 8 cm	1092 / 1132	1192 / 1232	1292 / 1332	1392 / 1432	1492 / 1532	1592 / 1632	1692 / 1732	1792 / 1832	1892 / 1932	1992 / 2032	2092 / 2132
H1	Door leaf height	2030	2030	2030	2030	2030	2030	2030	2030	2030	2030	2030
H2	Opening height in the wall	2060	2060	2060	2060	2060	2060	2060	2060	2060	2060	2060
H3	Frame outer height	2040	2040	2040	2040	2040	2040	2040	2040	2040	2040	2040
H4	Frame opening height	2018	2018	2018	2018	2018	2018	2018	2018	2018	2018	2018
H5	Frame cover width architrave 6 cm/ architrave 8 cm	2089 / 2109	2089 / 2109	2089 / 2109	2089 / 2109	2089 / 2109	2089 / 2109	2089 / 2109	2089 / 2109	2089 / 2109	2089 / 2109	2089 / 2109

REBATED DOUBLE-LEAF DOORS WITH FIXED DOOR FRAME

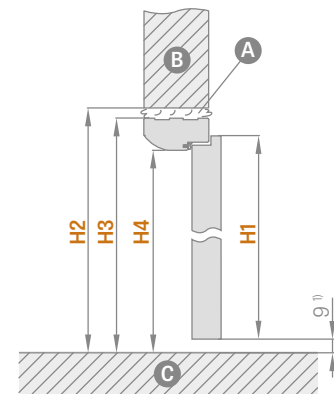
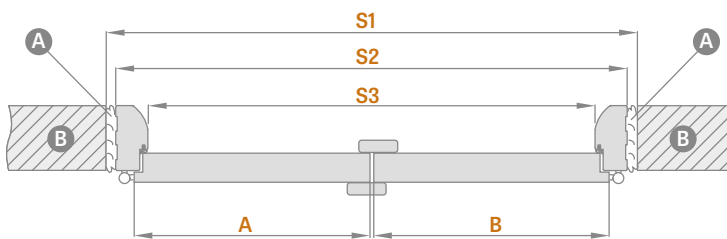

A-foam B-wall C-floor

Fixed door frame		DOUBLE-LEAF DOORS										
		"90"	"100"	"110"	"120"	"130"	"140"	"150"	"160"	"170"	"180"	"190"
A+B	Door leaf width	988	1088	1188	1288	1388	1488	1588	1688	1788	1888	1988
S1	Opening width in the wall	1068	1168	1268	1368	1468	1568	1668	1768	1868	1968	2068
S2	Frame outer width	1038	1138	1238	1338	1438	1538	1638	1738	1838	1938	2038
S3	Frame opening width	950	1050	1150	1250	1350	1450	1550	1650	1750	1850	1950
H1	Door leaf height	2030	2030	2030	2030	2030	2030	2030	2030	2030	2030	2030
H2	Opening height in the wall	2077	2077	2077	2077	2077	2077	2077	2077	2077	2077	2077
H3	Frame outer height	2062	2062	2062	2062	2062	2062	2062	2062	2062	2062	2062
H4	Frame opening height	2018	2018	2018	2018	2018	2018	2018	2018	2018	2018	2018

¹⁾ allowable deviation due to frame dimensional tolerance of +- 3mm (we recommend to check before installation)



FOLDING DOORS



FOLDING DOOR LEAF

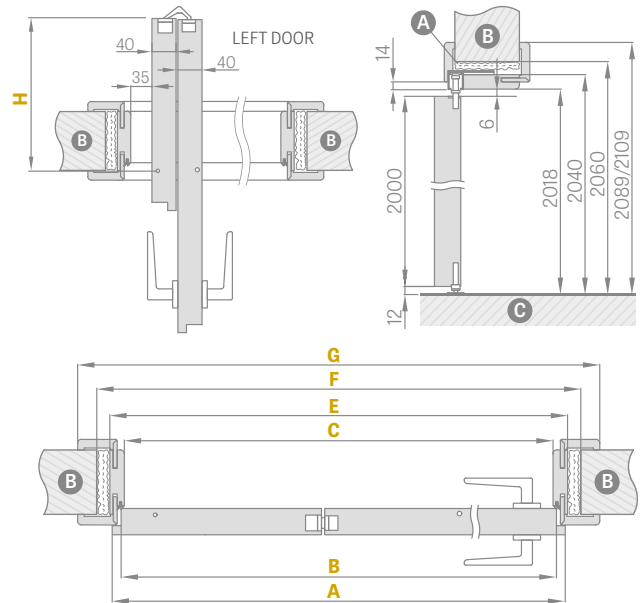

CONSTRUCTION

- The door leaf is composed of two parts joined with concealed hinges
- MDF stile covered with two HDF boards or internal timber stile covered with two HDF boards for PREMIUM and cpl laminates
- honeycomb stabilising filling or solid core filling for an additional charge

FINISHING

- laminated HDF board
- STANDARD leaf edge
- the edge laminated with edging in the same colour as the door leaf plane or optionally in black plain edging (black edging with horizontal grain for the HORIZONTAL LARCH finish)

HARDWARE

- three concealed hinges between leaves
- concealed guiding system in the top and bottom door sections
- a deadbolt lock, euro profile cylinder, economy lock or with a thumb turn

EXTRA CHARGES

solid core filling

"100" door leaf

black door leaf edge finish

Door width	A	B	C	E	F	G	H
"60"	641	614	604	648	688	746*/786**	152.5
"70"	741	714	704	748	788	846*/886**	202.5
"80"	841	814	804	848	888	946*/986**	252.5
"90"	941	914	904	948	988	1046*/1086**	302.5
"100"	1041	1014	1004	1048	1088	1146*/1186**	352.5

* Architraves 6 cm / ** Architraves 8 cm; joints at 45 degrees only

AVAILABLE DOOR LEAF WIDTHS

60 70 80 90 100



Installation vide
<https://youtu.be/tzccmzy7rvq>

STANDARD

LIGHT ACACIA FINISH	WHITE GREKO ¹⁾	SNOW-WHITE GREKO ¹⁾	GREKO WALNUT	SANREMO GREKO	GREKO SONOMA	MEDIUM GREKO OAK	GREKO ELM
GOLDEN GREKO OAK	GREKO GREY OAK	GREKO WHITE PINE	WALNUT PREMIUM	GREY MAPLE PREMIUM	OAK PREMIUM	WHITE BARK PREMIUM	GRAPHITE ASH PREMIUM
CONCRETE PREMIUM	WHITE PREMIUM ¹⁾	NATUR OAK PREMIUM	OAK ST CPL	GREY OAK ST CPL	VENGE ST CPL	NEW NATUR OAK PREMIUM HORIZONTAL ³⁾	NEW WHITE ST CPL ^{1) 2)}
CAPPUCCINO ST CPL ²⁾	LIGHT-GREY ST CPL ²⁾	BLACK ST CPL ²⁾	GREY PINE ST CPL	NEW WHITE ST CPL ^{1) 2)}			

¹⁾ plain white laminate imitating a painted surface

²⁾ special **AntiFinger** **NEW** coating to reduce dirt and fingerprints

³⁾ available as of 01/04/2022

Adjustment Range min-max (mm)	Adjustment Range min-max (mm)
80-100	260-280
100-120	260-300
120-140	280-300
140-160	300-320
160-180	320-340
180-200	340-360
200-220	360-380
220-240	380-400
240-260	400-420

Each 2 cm will be charged extra (based on the price range of 400-420 mm) until the range of 500-520 mm



COVERT CONCEALED DOOR SYSTEM

OPENING INWARDS AND OUTWARDS



REBATED AND NON-REBATED DOOR LEAF

ALUMINIUM CONCEALED DOOR FRAME

CONSTRUCTION

- rebated or non-rebated door leaf
- wooden stile covered with two HDF boards
- honeycomb stabilising filling or solid core filling for an additional charge

FINISHING

- HDF board covered with PREMIUM laminate, UV paint or a laminate designed for subsequent paint coating or wallpapering
- door leaf edge made in rebated or non-rebated technology

HARDWARE

- required two mortise hinges in the door frame (third optional, at an extra charge)
- magnetic lock in the rebated and non-rebated leaf: with a key, thumb turn cylinder, economy or with a blockade

EXTRA CHARGES

white or black door frame ³⁾ **NEW**

painted door leaf; WHITE TITANIUM UV

solid core filling

additional bottom bar in the leaf (can be cut by customer up to max 8 cm)

round and square metal sleeves (4 pcs);
finish: brushed nickel, patina, white and black

plastic woodgrain sleeves (4 pcs)

ventilation door cut or grille

third hinge **NEW**

can be changed to a black magnetic catch in the leaf

can be changed to hinges and catch plate in black
- for two hinges or
- for three hinges

"100" door leaf

drop-down gasket ⁴⁾

magnetic stop (buffer) ⁴⁾ **NEW**
(available in six colours p. 132)

AVAILABLE DOOR LEAF WIDTHS

60 70⁵⁾ 80⁵⁾ 90 100

¹⁾ plain white laminate imitating a painted surface

²⁾ used for wallpaper hanging and painting

³⁾ aluminium colour frame as standard

⁴⁾ a stop prevents application of a drop-down gasket and vice versa

⁵⁾ WHITE BASE leaves and aluminium door frame width "70" and "80" available on short lead times – ask your dealer for details

⁶⁾ special **AntiFinger** **NEW** coating to reduce dirt and fingerprints

⁷⁾ available as of 01/04/2022

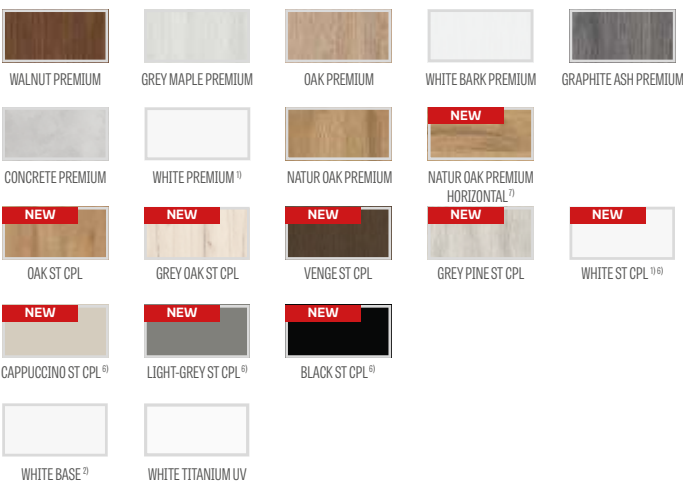



COVERT CONCEALED DOOR SYSTEM

INWARDS OPENING REBATED DOOR LEAF

REBATED DOOR LEAF

ALUMINIUM CONCEALED DOOR FRAME

STANDARD DIMENSIONS FOR INWARDS OPENING REBATED DOOR LEAVES

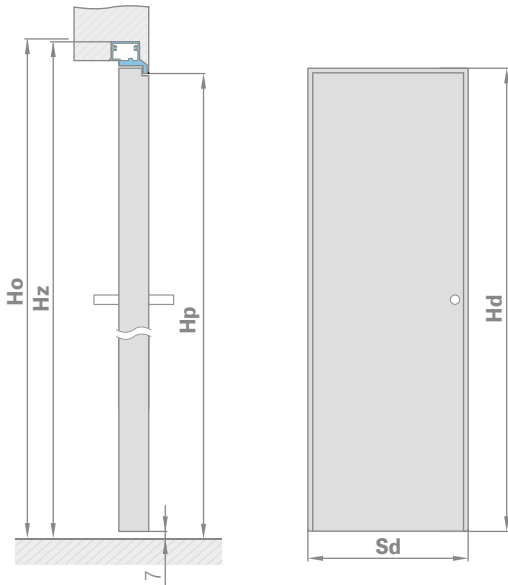

Door leaf width	Construction opening width	Frame outer width	Clear opening width
Sd [mm]	So [mm]	Sz [mm]	Sp [mm]
620	700	690	605
720	800	790	705
820	900	890	805
920	1000	990	905
1020	1100	1090	1005

Door leaf height	Construction opening height	Frame outer height	Clear opening height
Hd [mm]	Ho [mm]	Hz [mm]	Hp [mm]
2030	2079	2072	2030

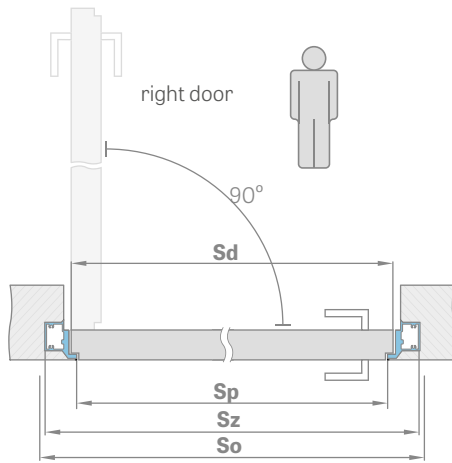

Gypsum board installation

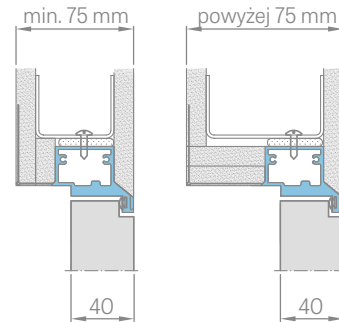

ALUMINIUM DOOR FRAME CROSS-SECTION

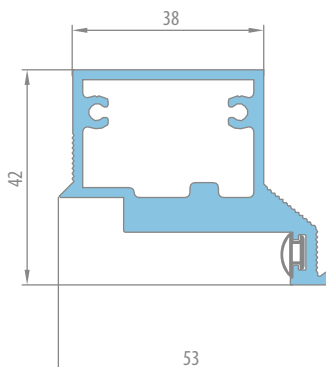

ENCLOSED IN WALL

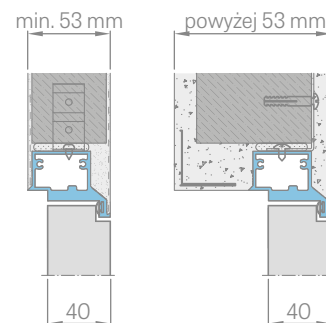



COVERT CONCEALED DOOR SYSTEM

OUTWARDS OPENING NON-REBATED DOOR LEAF

NON-REBATED DOOR LEAF

ALUMINIUM CONCEALED DOOR FRAME

STANDARD DIMENSIONS FOR OUTWARDS OPENING NON-REBATED DOOR LEAVES

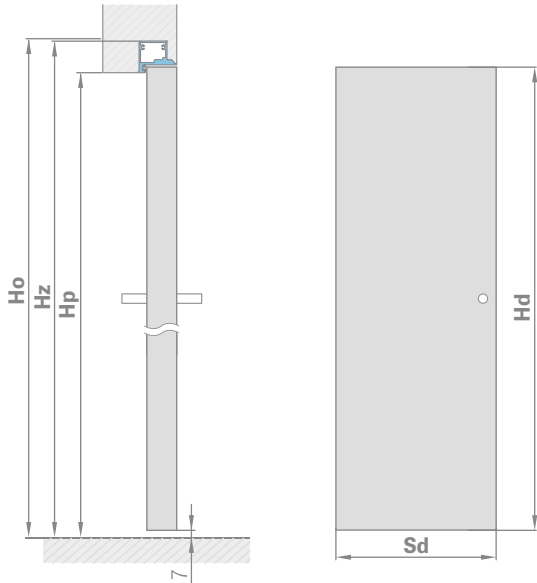

Door leaf width	Construction opening width	Frame outer width	Clear opening width
Sd [mm]	So [mm]	Sz [mm]	Sp [mm]
620	700	690	605
720	800	790	705
820	900	890	805
920	1000	990	905
1020	1100	1090	1005

Door leaf height	Construction opening height	Frame outer height	Clear opening height
Hd [mm]	Ho [mm]	Hz [mm]	Hp [mm]
2020	2069	2062	2020

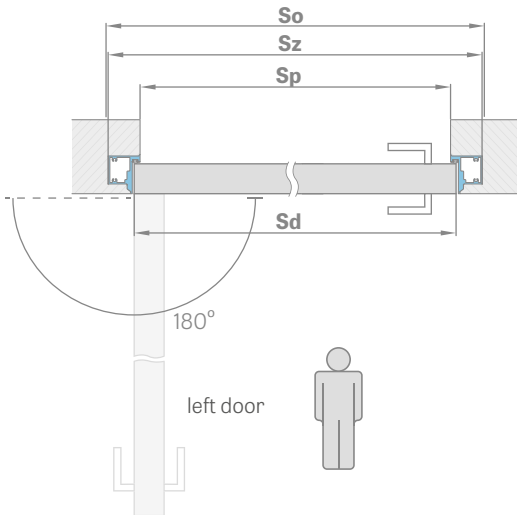

Gypsum board installation

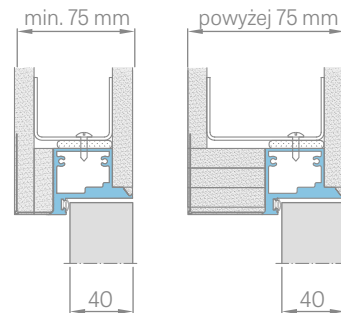

ALUMINIUM DOOR FRAME CROSS-SECTION

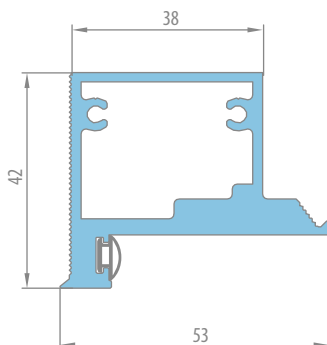

ENCLOSED IN WALL

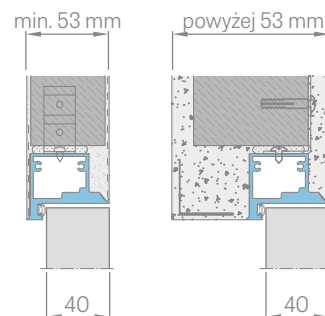



LIGHTING

REBATED

GENERAL INFORMATION

The top and side lights are preassembled and glazed with the VSG 331 safety glass in a frosted or transparent variant. (Please state your choice of glass when placing orders)

AVAILABLE PRODUCT PACKAGES

LIGHTING CATEGORIES

FOR FIXED DOOR FRAMES

FOR ADJUSTABLE DOOR FRAMES

FOR SINGLE LEAF DOORS

FOR DOUBLE-LEAF DOORS

SINGLE LEAF DOORS with top, side and corner lights

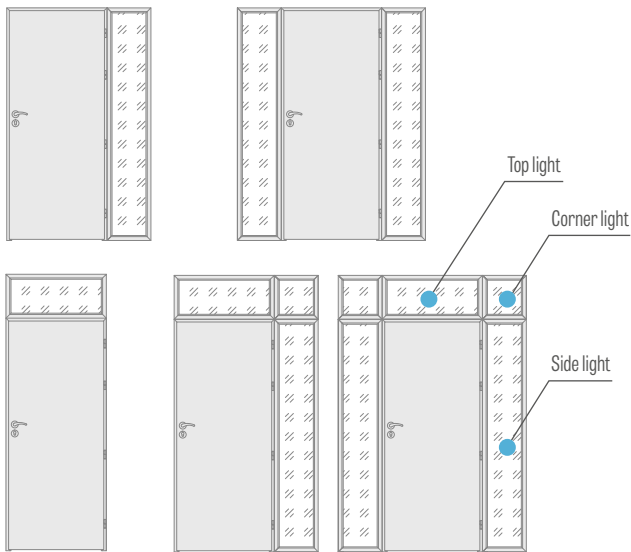

DOUBLE-LEAF DOORS with top, side and corner lights

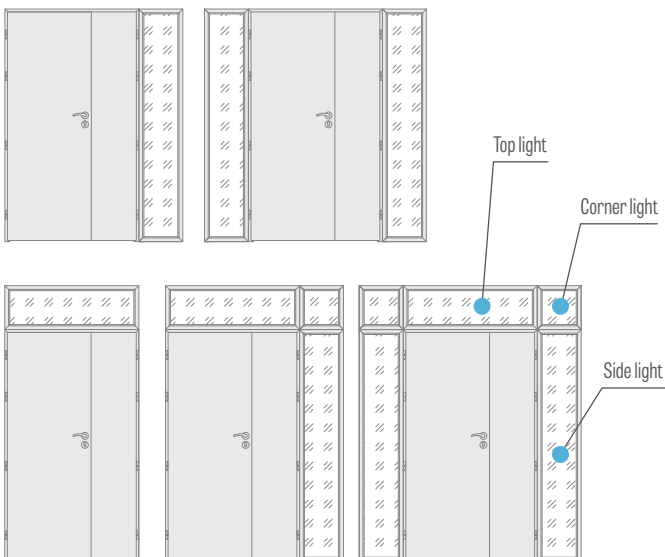

** Ranges available as for the standard adjustable rebated door frames, see p. -163

- The matt VSG 331 or transparent VSG 331 safety glass is included and the price is the same for all laminates and ranges for rebated door frames.
- To paint coated lights + 50% charge applies
- Fitting strips for lights are fixed with headless pins which are seen as small dark spots once nailed (especially in white laminates and paint coated lights).
- Lighting not available in CPL 0.2 and CPL 0.7 laminates

Side lights for adjustable door frame
strip 6cm /strip 8cm

"30" "40" "50" "60"

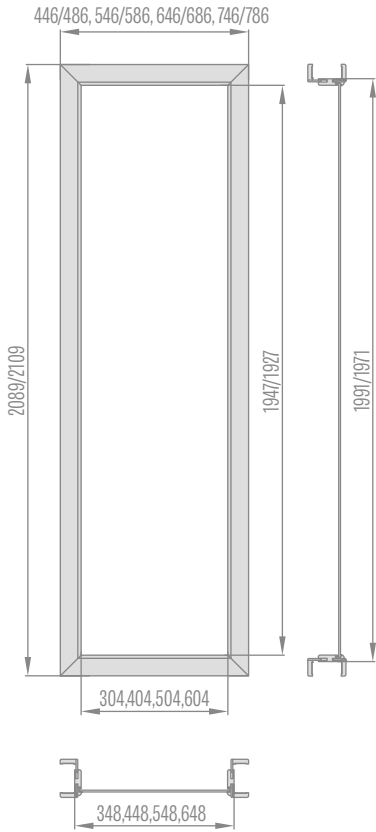

Corner lights for adjustable door frame
strip 6cm /strip 8cm

"30" "40" "50" "60"

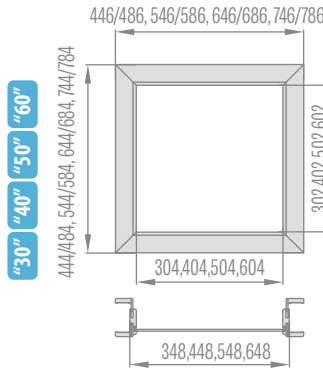

Top lights for adjustable door frame in single leaf doors
strip 6 cm /strip 8cm

"60" "70" "80" "90" "100"

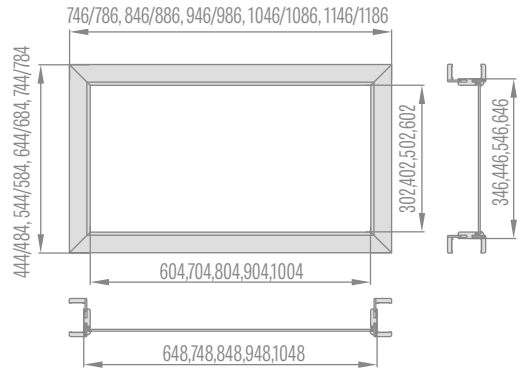

Top lights for adjustable door frame in double-leaf doors strip 6cm /strip 8cm

"90" "100" "110" "120" "130" "140" "150" "160" "170" "180" "190"

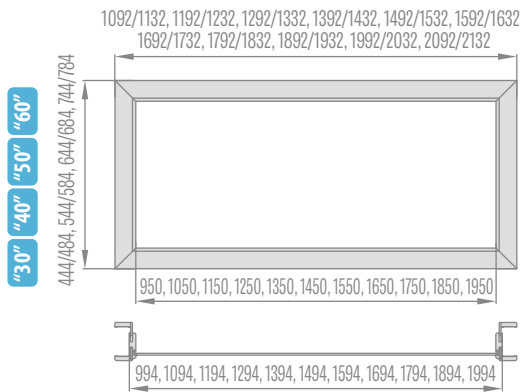

Calculation scheme for the wall opening height
for an adjustable frame:

- overall frame height
- + overall top light height
- 29 mm (for 60 mm angle bar) or 49 mm (for 80 mm angle bar)

Calculation scheme for the wall opening width
for an adjustable frame:

- overall frame width
- + overall top light width
- 58 mm (for 60 mm angle bar) or 98 mm (for 80 mm angle bar)

Side lights for fixed door frame

"30" "40" "50" "60"

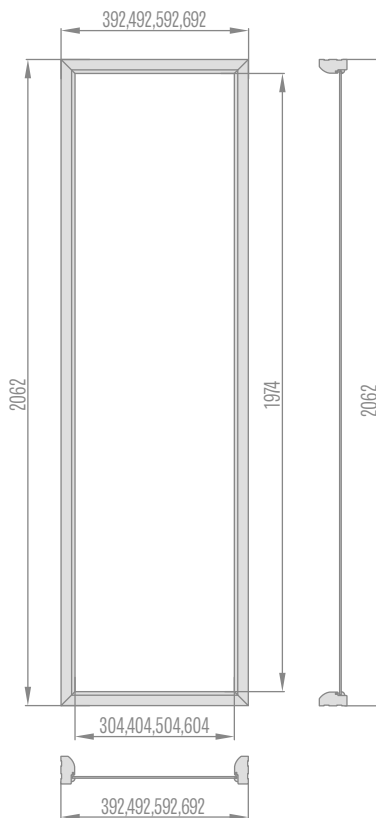

Corner lights for fixed door frame

"30" "40" "50" "60"

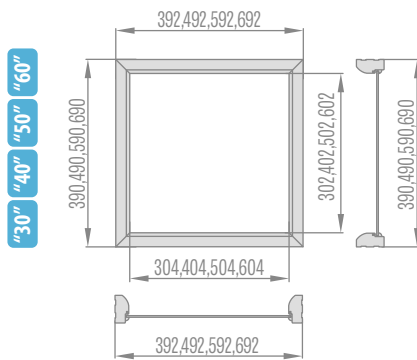

Top lights for fixed door frame in single leaf doors

"60" "70" "80" "90" "100"

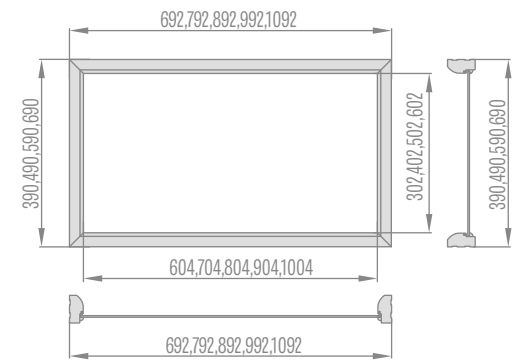

Top lights for fixed door frame in double-leaf doors

"90" "100" "110" "120" "130" "140" "150" "160" "170" "180" "190"



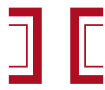

DOOR FRAMES

- The adjustable and fixed rebated door frames can be used for all types of ERKADO internal doors made in both flush and STILE technologies.
- The adjustable non-rebated door frames can be used for internal doors made in both flush and STILE technologies. These door frames are supplied with three concealed hinges.
- The door frame is made with high quality MDF board and covered with durable wood grain film or coated with durable UV paint.
- Depending on the technology, the door frames are laminated with: FINISH, GREKO, CPL, PREMIUM and UV paint.
- The frames for STILE doors have a third hinge as standard.
- Each adjustable and fixed frame comes complete with disassembled frame components, hinges and screws. The components are supplied with pre-drilled holes for fixing.
- Each set is enclosed with assembly manual and warranty certificate.
- The fixed door frame for Herse collection is rectangular and its core is made of glulam timber.

**ADJUSTABLE DOOR FRAME
REBATED DOOR LEAVES**



**ADJUSTABLE OVERLAY FRAME FOR
STEEL DOOR FRAME**



**ADJUSTABLE DOOR FRAME
NON-REBATED DOOR LEAVES**



**STAND FIXED DOOR FRAME
REBATED DOOR LEAVES**



STANDARD SQUARE FOR AN ADJUSTABLE DOOR FRAME

strip 6 cm /strip 8 cm

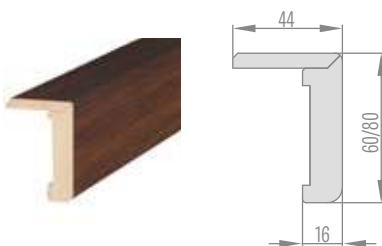

SQUARE WITH EXTENDED TONGUE FOR ADJUSTABLE DOOR FRAME

strip 6 cm /strip 8 cm

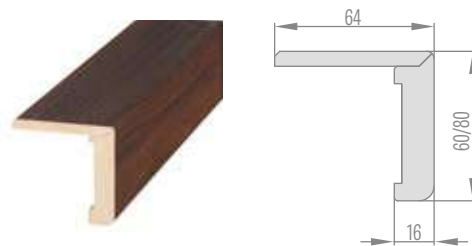

FIXED DOOR FRAME

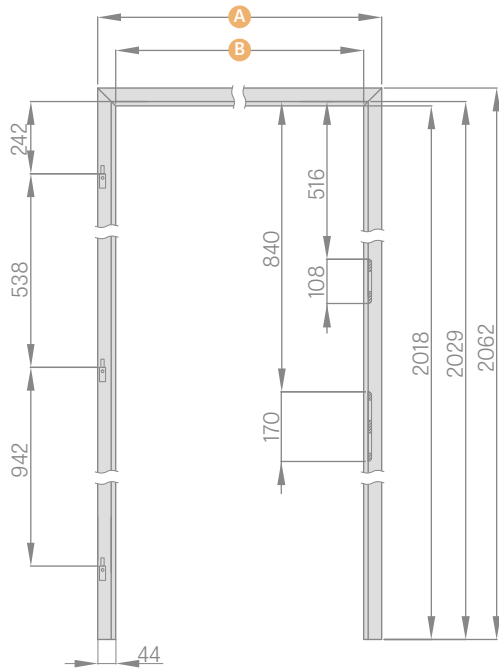

	"60"	"70"	"80"	"90"	"100"	"110"
A	692	792	892	992	1092	1192
B	604	704	804	904	1004	1104

ADJUSTABLE DOOR FRAME

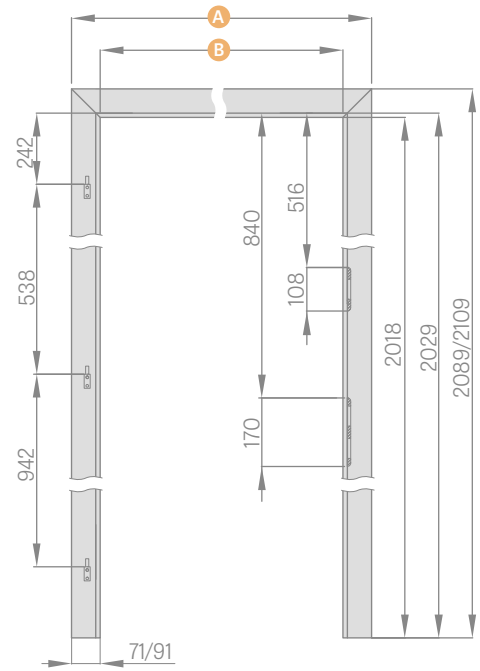

	"60"	"70"	"80"	"90"	"100"	"110"
A	746/786	846/886	946/986	1046/1086	1146/1186	1246/1286
B	604	704	804	904	1004	1104

strip 6cm /strip 8cm

TUNNEL TYPE ADJUSTABLE DOOR FRAME

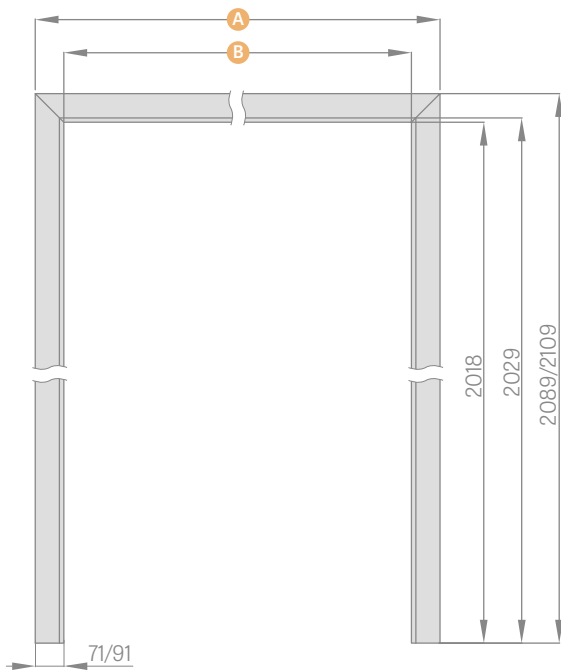

	"60"	"70"	"80"	"90"	"100"	"110"	"120"
A	746/786	846/886	946/986	1046/1086	1146/1186	1246/1286	1346/1386
B	604	704	804	904	1004	1104	1204

	"130"	"140"	"150"	"160"	"170"	"180"	"190"
A	1446/1486	1546/1586	1646/1686	1746/1786	1846/1886	1946/1986	2046/2086
B	1304	1404	1504	1604	1704	1804	1904

strip 6cm /strip 8cm

CASING DOOR FRAME

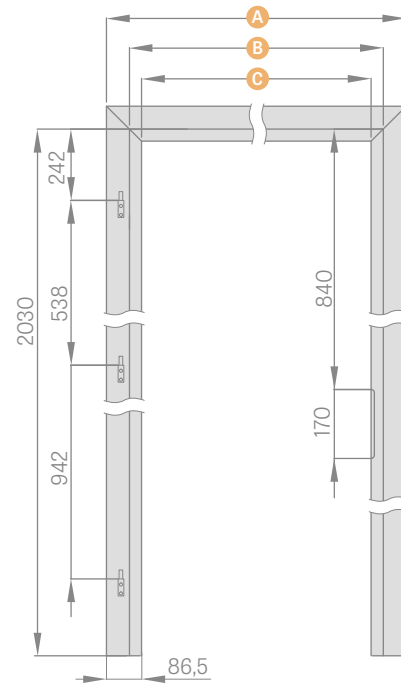

	"60"	"70"	"80"	"90"	"100"
A	737	837	937	1037	1137
B	624	724	824	924	1024
C	564	664	764	864	964

FIXED DOOR FRAME FOR DOUBLE-LEAF DOORS

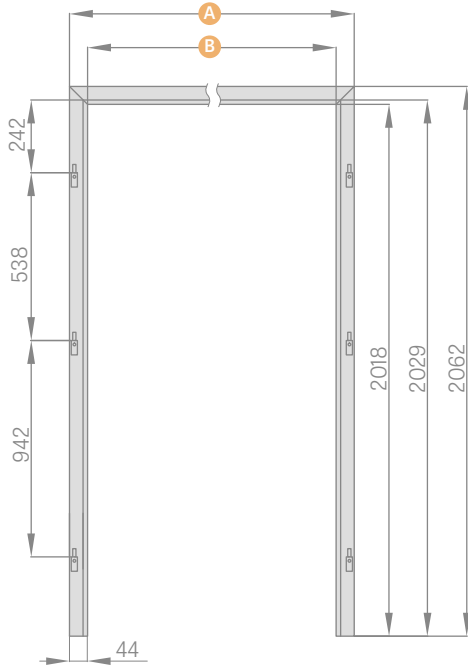

	"90"	"100"	"110"	"120"	"130"	"140"
A	1038	1138	1238	1338	1438	1538
B	950	1050	1150	1250	1350	1450

	"150"	"160"	"170"	"180"	"190"
A	1638	1738	1838	1938	2038
B	1550	1650	1750	1850	1950

ADJUSTABLE DOOR FRAME FOR DOUBLE-LEAF DOORS

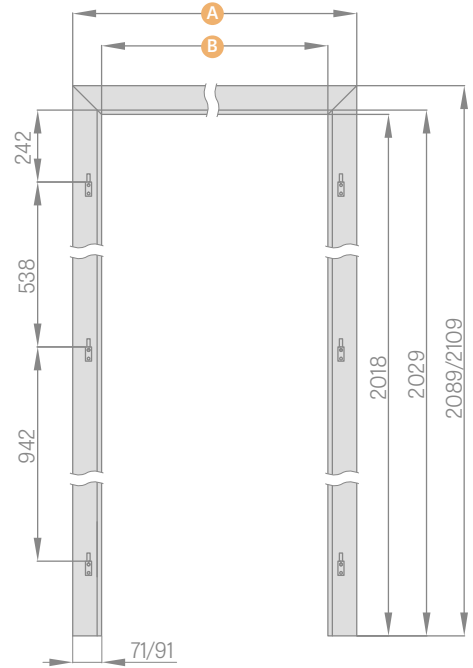

	"90"	"100"	"110"	"120"	"130"	"140"
A	1092/1132	1192/1232	1292/1332	1392/1432	1492/1532	1592/1632
B	950	1050	1150	1250	1350	1450

	"150"	"160"	"170"	"180"	"190"
A	1692/1732	1792/1832	1892/1932	1992/2032	2092/2132
B	1550	1650	1750	1850	1950

strip 6cm /strip 8cm

FIXED DOOR FRAME FOR GLASS DOORS

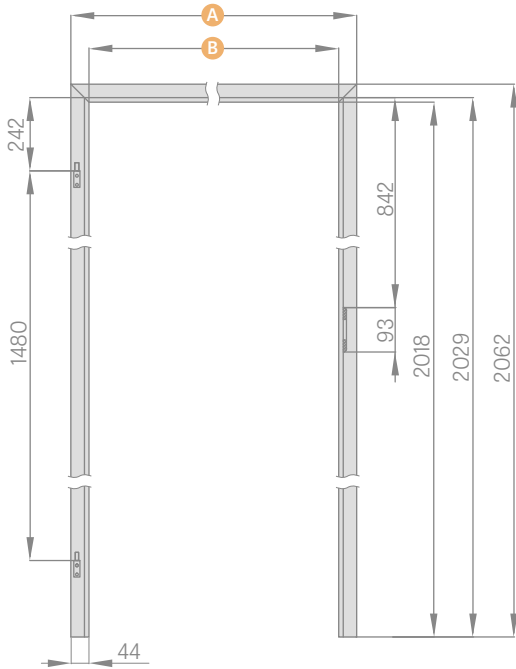

	"60"	"70"	"80"	"90"
A	692	792	892	992
B	604	704	804	904

10 mm pin hinge for glass panes frames

ADJUSTABLE DOOR FRAME FOR GLASS DOORS

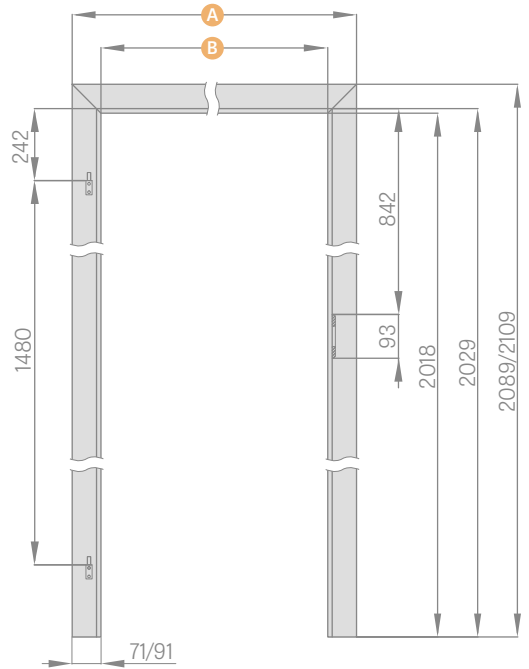

	"60"	"70"	"80"	"90"
A	746/786	846/886	946/986	1046/1086
B	604	704	804	904

strip 6cm /strip 8cm

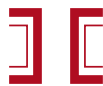

TUNNEL TYPE ADJUSTABLE DOOR FRAME

REBATED / NON-REBATED

TUNNEL TYPE DOOR FRAMES

The tunnel type door frames are adjustable door frames without any hardware. They are made with a top strip and two vertical strips.

They can be used to finish door openings and safeguard wall corners, but mainly are fitted for interior decoration effects.

The tunnel type adjustable rebated door frames are also used in the ERKADO sliding systems.

The tunnel type adjustable non-rebated door frames are not used in the sliding systems.

Depending on the system, we use the following rebated tunnels:

TUNNEL FOR SP1N	Wall-mounted single sliding system
TUNNEL FOR SP2N	Wall-mounted double sliding system
TUNNEL FOR SP1C.100	Single "100" pocket sliding system
TUNNEL FOR SP2C.100	Double "100" pocket sliding system
TUNNEL FOR SP1C.125	Single "125" pocket sliding system
TUNNEL FOR SP2C.125	Double "125" pocket sliding system
Encasing ZN1	Wall encasing for one side of the single leaf systems SP1C.100 and SP1C.125
Encasing ZN2	Wall encasing for one side of the double-leaf systems SP2C.100 i SP2C.125

ADJUSTABLE REBATED TUNNELS

	"60"	"70"	"80"	"90"	"100"	"110"	"120"	"130"	"140"	"150"	"160"	"170"	"180"	"190"
Opening width in the wall	688	788	888	988	1088	1188	1288	1388	1488	1588	1688	1788	1888	1988
Tunnel outer width	648	748	848	948	1048	1148	1248	1348	1448	1548	1648	1748	1848	1948
Tunnel opening width	604	704	804	904	1004	1104	1204	1304	1404	1504	1604	1704	1804	1904
Frame cover width architraves 6 cm / Architraves 8 cm	746/786	846/886	946/986	1046/1086	1146/1186	1246/1286	1346/1386	1446/1486	1546/1586	1646/1686	1746/1786	1846/1886	1946/1986	2046/2086
Opening height in the wall	2060	2060	2060	2060	2060	2060	2060	2060	2060	2060	2060	2060	2060	2060
Tunnel outer height	2040	2040	2040	2040	2040	2040	2040	2040	2040	2040	2040	2040	2040	2040
Tunnel opening height	2018	2018	2018	2018	2018	2018	2018	2018	2018	2018	2018	2018	2018	2018
Tuner cover height architrave 6 cm / architrave 8 cm	2089/2109	2089/2109	2089/2109	2089/2109	2089/2109	2089/2109	2089/2109	2089/2109	2089/2109	2089/2109	2089/2109	2089/2109	2089/2109	2089/2109

ADJUSTABLE NON-REBATED TUNNELS

	"60"	"70"	"80"	"90"	"100"	"110"	"120"	"130"	"140"	"150"	"160"	"170"	"180"
Opening width in the wall	713	813	913	1013	1113	1213	1313	1413	1513	1613	1713	1813	1913
Tunnel outer width	673	773	873	973	1073	1173	1273	1373	1473	1573	1673	1773	1873
Tunnel opening width	629	729	829	929	1029	1129	1229	1329	1429	1529	1629	1729	1829
Frame cover width architraves 6 cm / Architraves 8 cm	771/811	871/911	971/1011	1071/1111	1171/1211	1271/1311	1371/1411	1471/1511	1571/1611	1671/1711	1771/1811	1871/1911	1971/2011
Opening height in the wall	2073	2073	2073	2073	2073	2073	2073	2073	2073	2073	2073	2073	2073
Tunnel outer height	2053	2053	2053	2053	2053	2053	2053	2053	2053	2053	2053	2053	2053
Tunnel opening height	2031	2031	2031	2031	2031	2031	2031	2031	2031	2031	2031	2031	2031
Tuner cover height architrave 6 cm / architrave 8 cm	2102/2122	2102/2122	2102/2122	2102/2122	2102/2122	2102/2122	2102/2122	2102/2122	2102/2122	2102/2122	2102/2122	2102/2122	2102/2122



STEEL DOOR FRAME

FOR GRAF STILE, PANEL & GLASS DOOR LEAVES

ADJUSTABLE STEEL DOOR FRAME (OVERLAPPING), plate thk. 1.5 mm

welded and coated in RAL 9003, 9010, 9016, 8003, 8017, 7016, 7022, 7047, 1001

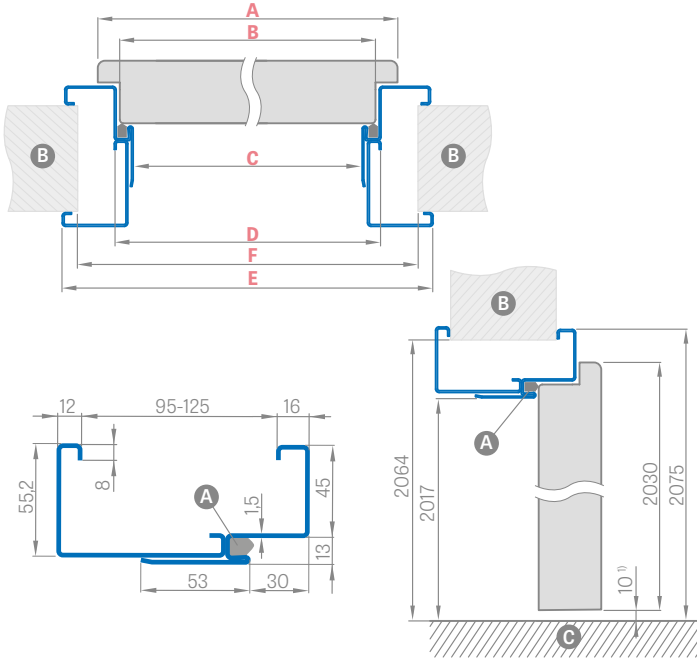

SQUARE STEEL DOOR FRAME (LARGE), sheet metal thk. 1.2 mm

welded and coated in RAL 9003, 9010, 9016, 8003, 8017, 7016, 7022, 7047, 1001

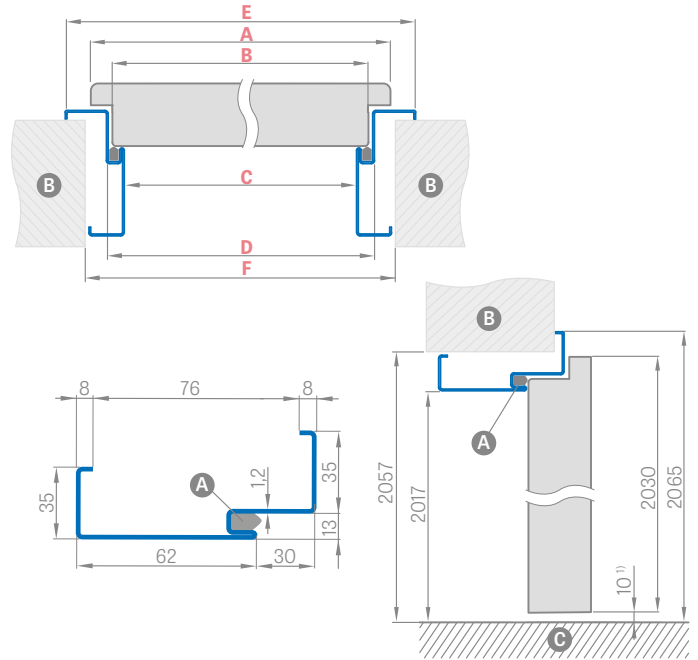

¹⁾ allowable deviation due to frame dimensional tolerance of +-3mm (we recommend to check before installation)

Door width	A	B	C	D	E	F
"60"	644	617	601	627	717	695
"70"	744	717	701	727	817	795
"80"	844	817	801	827	917	895
"90"	944	917	901	927	1017	995
"100"	1044	1017	1001	1027	1117	1095
"110"	1144	1117	1101	1127	1217	1195

Door width	A	B	C	D	E	F
"60"	644	617	601	627	697	681
"70"	744	717	701	727	797	781
"80"	844	817	801	827	897	881
"90"	944	917	901	927	997	981
"100"	1044	1017	1001	1027	1097	1081
"110"	1144	1117	1101	1127	1197	1181

Adjustment range min-max (mm)
95-125
125-155
155-185
185-215
215-245
245-275
275-305

FITTING THE SQUARE FRAME

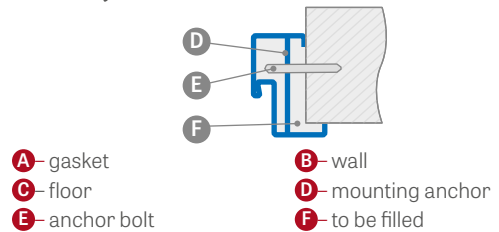

EXTRA CHARGES

electric door strike	
door closer reinforcement	
galvanised sheet steel	+10%
adjustable frame "100" or "110"	
fixed frame "100" or "110"	
door frame for double-leaf doors	Bespoke pricing
non-typical RAL (intensive, pearly and metallic colours not included)	10% extra charge

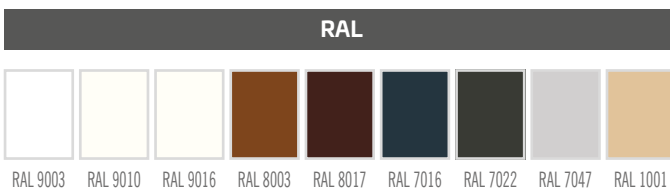



ADJUSTABLE OVERLAY DOOR FRAME

FOR STEEL DOOR FRAMES

HANDLE POSITION IN AN OVERLAY DOOR FRAME

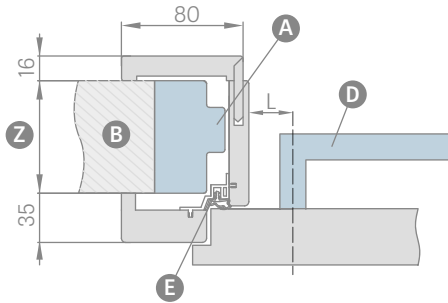

L – distance between the handle centre line and the frame strip edge
 L = 23 mm for panel doors, SYDNEY or QUBIK handle, with long face plate, p. 126
 L = 28 mm for STILE frame doors (all interior door handles presented in the offer are available)

NOTE: Check the handle face plate dimensions before installation.
 Adjustable overlay door frame of over 200 mm consists of two components, and a frame of over 320 mm consists of three elements.

AVAILABLE WIDTHS FOR OVERLAY FRAMES:

60 70 80 90 100

	Adjustment range min-max (mm)
1 component	80-100
	100-120
	120-140
	140-160
	160-180
2 Components	180-200
	200-220
	220-240
	240-260
	260-280
3 Components	280-300
	300-320
	320-340
	340-360
	360-380
	380-400
	400-420
	420-440

OVERLAY DOOR FRAME DIAGRAM

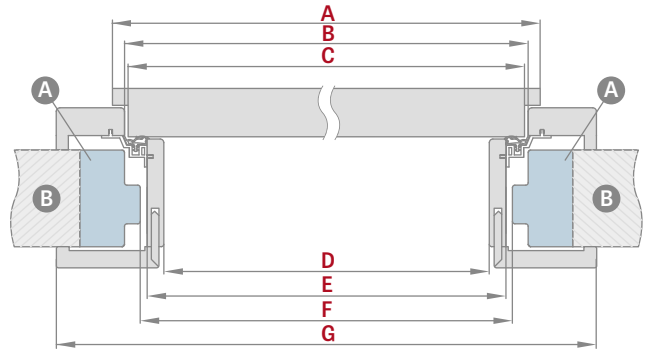

Door width	A	B	C	D	E	F	G
"60"	644	624	618	564	592	598	733
"70"	744	724	718	664	692	698	833
"80"	844	824	818	764	792	798	933
"90"	944	924	918	864	892	898	1033
"100"	1044	1024	1018	964	992	998	1133

F – min dimension of the steel frame opening, on which to fit an overlay door frame. This dimension can exceed the recommended one by max 20 mm. For greater frame opening, ensure the architraves cover the wall appropriately.

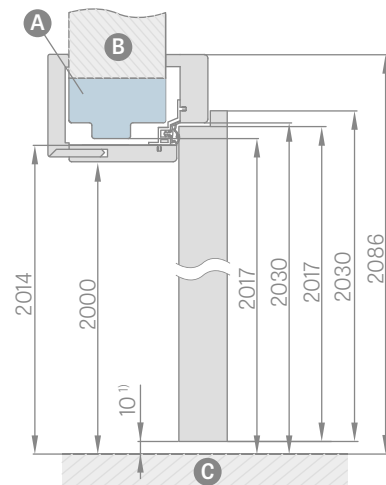

¹⁾ allowable deviation due to frame dimensional tolerance of +- 3 mm (we recommend to check before installation)

- A** – steel door frame
- B** – wall
- C** – floor
- D** – handle
- E** – aluminium profile with gasket
- Z** – range from 80 mm to 255 mm

- 120 mm extension for overlay frame
- Standard square for an overlay frame
- Square with extended tongue
- Tunnel type door frame for widths of 60, 70, 80, 90, 100 are at the price of the adjustable overlay door frame.
- The tunnel is of the same dimensions as the overlay door frame and is not pre-drilled for hinge or door striker plate, but is supplied with a gasket.

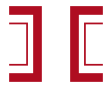

REVERSE DOOR FRAME

REVERSE DOOR LEAVES

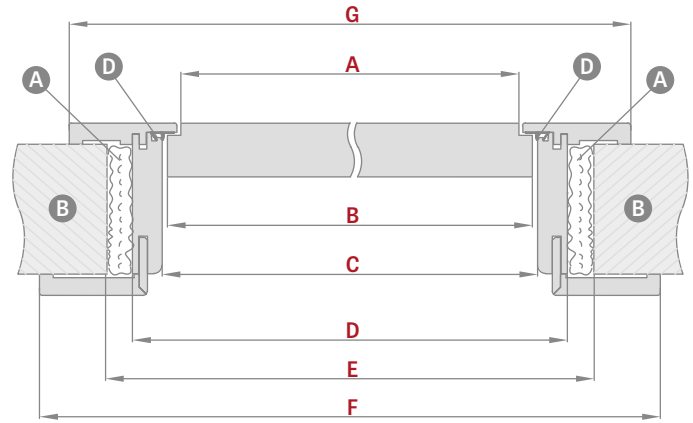
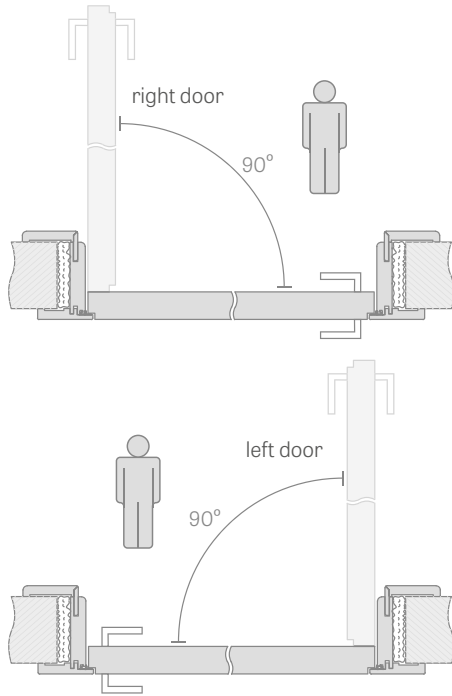

ADJUSTMENT RANGE FOR REVERSE DOOR FRAME

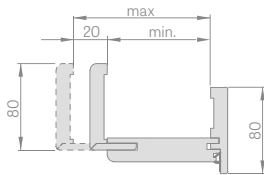

		Adjustment range min-max (mm)
1 component		75-95
		95-115
		115-135
		135-155
		155-175
2 Components		175-195
		195-215
		215-235
		235-255
		255-275
		275-295
		295-315
		315-335
	335-355	

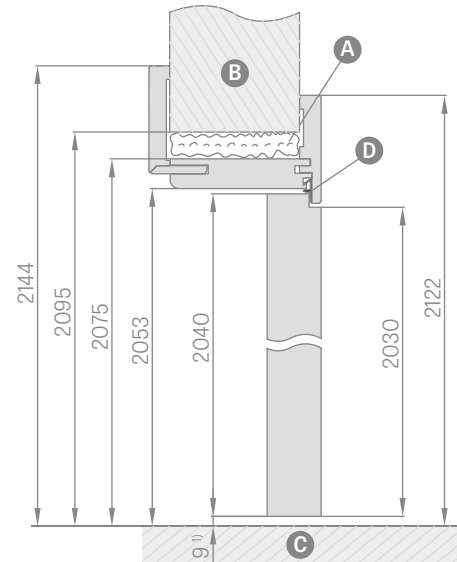

¹⁾ allowable deviation due to frame dimensional tolerance of +- 3 mm
(we recommend to check before installation)

Door width	A	B	C	D	E	F	G
"60"	624	644	652	696	736	834	791
"70"	724	744	752	796	836	934	891
"80"	824	844	852	896	936	1034	991
"90"	924	944	952	996	1036	1134	1091
"100"	1024	1044	1052	1096	1136	1234	1191
"110"	1124	1144	1152	1196	1236	1334	1291

A foam **B** wall **C** floor **D** rubber gasket

- The frame for reverse leaves is available as a standard with 8 cm angle joined at 45 degrees or 90 degrees at an extra charge (not available for 75-95 mm) **NEW**
- The frame contains two so-called concealed hinges invisible when the leaf is closed
- Available decors within the colour group: GREKO, PREMIUM, CPL and WHITE TITANIUM UV varnish
- Can be replaced with hinges and catch plate in black for the frame
- 120 mm extension for reversible laminate and lacquered frame
- Movable square with 2 cm longer tongue and standard square for adjustable frames with all laminates and lacquered
- The door frame above 255 mm is composed of two parts
- Top panels can be glued to the wall for an additional charge page 134



ADJUSTABLE DOOR FRAME

NON-REBATED DOOR LEAVES

ADJUSTABLE DOOR FRAME RANGE

80-95 mm

strip 6 cm / strip 8 cm

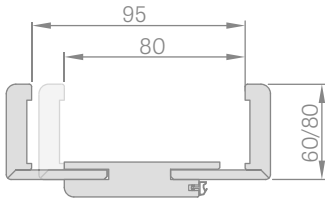

The square tongue is to be cut by customer to required size, for door frames within 80-95mm range

DOOR FRAME JOINTS

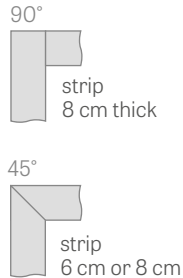

ADJUSTABLE DOOR FRAME DIAGRAM

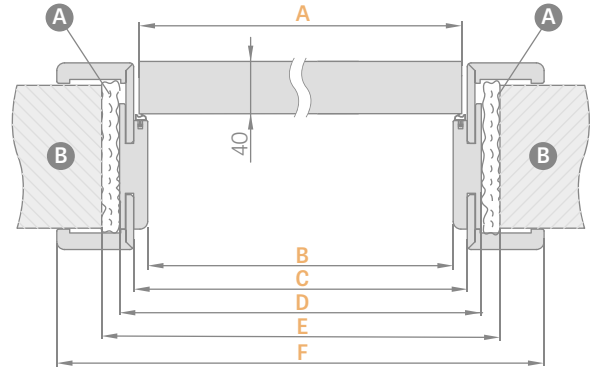

ADJUSTABLE DOOR FRAME RANGE

strip 6 cm / strip 8 cm

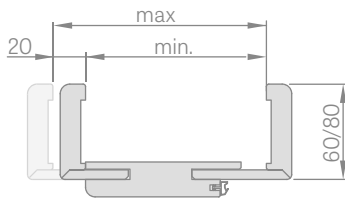

Door width	A	B	C	D	E	F
"60"	644	629	651	673	714	771*/811**
"70"	744	729	751	773	814	871*/911**
"80"	844	829	851	873	914	971*/1011**
"90"	944	929	951	973	1014	1071*/1111**
"100"	1044	1029	1051	1073	1114	1171*/1211**
"110"	1144	1129	1151	1173	1214	1271*/1311**

* strip 6 cm / ** strip 8 cm

Adjustment range min-max (mm)	
1 component	80-95
	95-115
	115-135
	135-155
	155-175
	175-195
2 Components	195-215
	215-235
	235-255
	255-275
	275-295
	295-315
	315-335
	335-355
355-375	
375-395	
395-415	

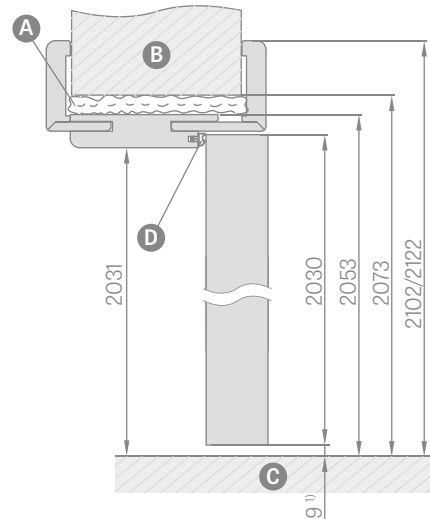

¹⁾ allowable deviation due to frame dimensional tolerance of +- 3 mm (we recommend to check before installation)

A foam **B** wall **C** floor **D** rubber gasket

- Adjustable rebate-free door frame in CPL0.2 is also used in combination with doors in CPL0.7
- Can be changed to hinges and catch plate in black
- Joints at 90 degrees possible for door frames with the 8 cm architraves only. Extra charge for frame joints at 90°
- The door frame above 295 mm is composed of two parts
- Prices of adjustable door frames for double-leaf doors + **30%**
- Extension 120 mm for non-rebated frame, laminated and CPL 0.2 and lacquered
- Movable square with 2 cm longer tongue and standard square for adjustable frames with all laminates CPL 0.2 and lacquered
- Tunnel type door frame for widths of 60, 70, 80, 90, 100 are at the price of the adjustable rebated door frame (see table p. 163)
- Tunnel type door frame for widths of 110, 120, 130, 140, 150, 160, 170, 180, 190 are at the price of the adjustable door frame for rebated double leaf doors (see table p. 163)
- Top panels glued to the wall (only for frames with 8 cm corner) - p. 134

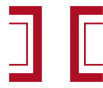

FIXED DOOR FRAME

REBATED DOOR LEAVES

FIXED DOOR FRAME

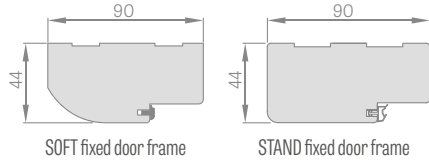

- FINISH
- GREKO
- ST CPL & PREMIUM
- CPL 0.2
- PAINTED

MASKING STRIP 8 mm

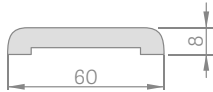

- FINISH
- GREKO
- ST CPL & PREMIUM
- CPL 0.2
- PAINTED

Price for a set of 2 pcs. x 213.5 cm and 1 pc. x 112 cm (for door leaves from "60" to "90")
 Price for a set of 3 pcs. x 213.5 cm (for door leaves from "100" to "190")

QUARTER ROUND

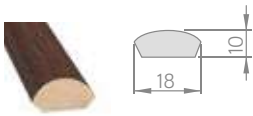

- FINISH
- GREKO
- ST CPL & PREMIUM
- PAINTED

Price for a set of 2 pcs. x 211.5 cm and 1 pc. x 106.5 cm (for door leaves from "60" to "90")
 Price for a set of 3 pcs. x 211.5 cm (for door leaves from "100" to "190")

ELECTRIC DOOR STRIKE

SKIRTING BOARD length 2,40 mb
 laminated
 lacquered

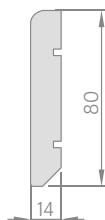

- The skirting board is made of moisture resistant MDF board. Available variants: WHITE TITANIUM UV paint, laminates: GREKO, ST CPL, PREMIUM and in base laminate to be paint coated.
- Fitting method: bonding to wall

CLIP-ON SQUARE 6 cm and 8 cm (3 pcs. of clips supplied)



- FINISH
- GREKO
- ST CPL & PREMIUM
- CPL 0.2
- PAINTED

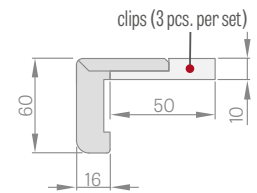
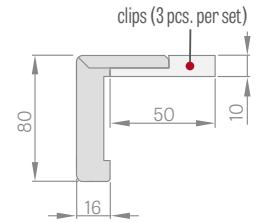

MASKING STRIP 16 mm

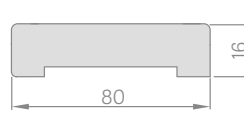

- FINISH
- GREKO
- ST CPL & PREMIUM
- CPL 0.2
- PAINTED

Price for a set of 2 pcs. x 214.5 cm and 1 pc. x 112 cm (for door leaves from "60" to "80")
 Price for a set of 3 pcs. x 214.5 cm (for door leaves from "90" to "180")

SOFT AND STAND FIXED DOOR FRAME DIAGRAM

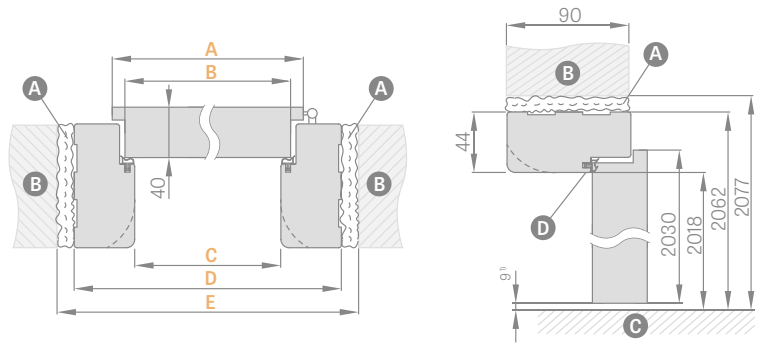

¹⁾ allowable deviation due to frame dimensional tolerance of +- 3 mm
 (we recommend to check before installation)

Door width	A	B	C	D	E
"60"	644	618	604	692	722
"70"	744	718	704	792	822
"80"	844	818	804	892	922
"90"	944	918	904	992	1022
"100"	1044	1018	1004	1092	1122
"110"	1144	1118	1104	1192	1222

A foam **B** wall **C** floor **D** rubber gasket

- Fixed door frame for double-leaf doors + 30%
- Non-rebated fixed door frame – NA
- The fixed frame, architrave and clip-on square in CPL 0.2 are also used in the set for door leaves in CPL 0.7
- Black striker plate only available for GRAF glass door frames



ADJUSTABLE DOOR FRAME

REBATED DOOR LEAVES



ADJUSTABLE DOOR FRAME
above 280 mm

Adjustable door frame above 280 mm is composed of two parts (not within the 260-300 mm range), and above 400 mm – three parts (they are not of equal size).

ADJUSTABLE DOOR FRAME DIAGRAM

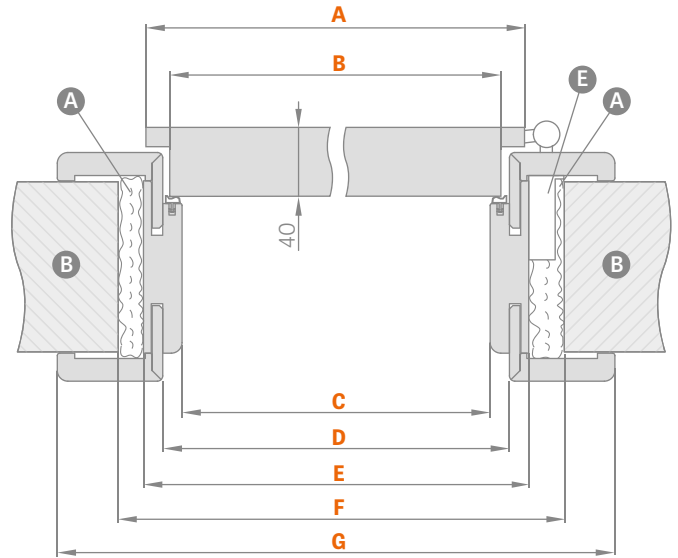

ADJUSTABLE DOOR FRAME RANGE

strip 6 cm / strip 8 cm

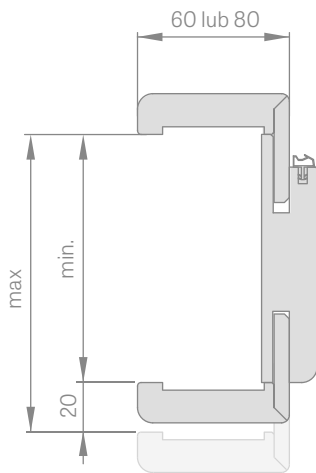

DOOR FRAME JOINTS

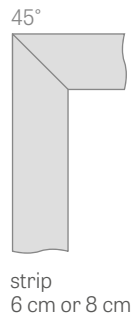
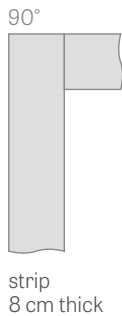

Door width	A	B	C	D	E	F	G
"60"	644	618	604	626	648	688	746*/786**
"70"	744	718	704	726	748	788	846*/886**
"80"	844	818	804	826	848	888	946*/986**
"90"	944	918	904	926	948	988	1046*/1086**
"100"	1044	1018	1004	1026	1048	1088	1146*/1186**
"110"	1144	1118	1104	1126	1148	1188	1246*/1286**

*strip 6 cm / **strip 8 cm

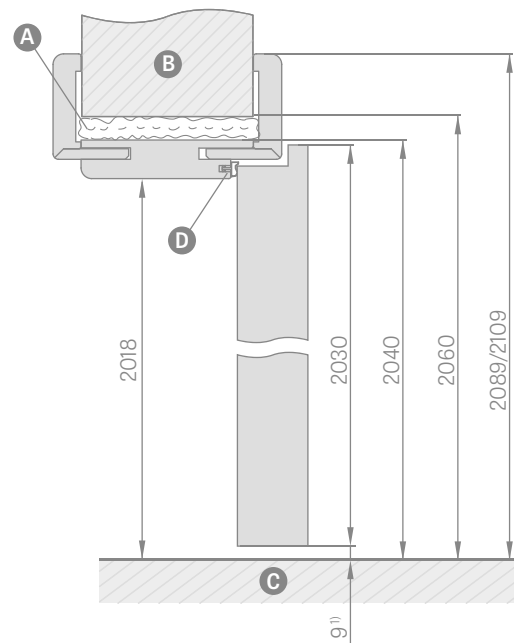

¹⁾ allowable deviation due to frame dimensional tolerance of +- 3 mm
(we recommend to check before installation)

- A** foam **B** wall **C** floor
- D** rubber seal **E** hinge seat

	Adjustment range min-max (mm)
1 component	80-100
	100-120
	120-140
	140-160
	160-180
	180-200
	200-220
	220-240
	240-260
	260-280
2 Components	260-300
	280-300
	300-320
	320-340
	340-360
	360-380
3 Components	380-400
	400-420

- The CPL 0.2 adjustable rebated frame is also used with CPL 0.7 door leaves
- Joints at 90 degrees possible for door frames with the 8 cm strips only. Additional charge for joining at 90 degrees
- Electric door strike
- Door closer reinforcement
- Prices of fixed and adjustable door frames for double-leaf doors + **30 %**
- Movable square with 2 cm longer tongue and standard square for adjustable frames with all laminates **CPL 0.2** and lacquered
- Black striker plate only available for GRAF glass door frames
- Extension 120 mm for adjustable frame, laminated and CPL 0.2 and lacquered
- possibility to make door frames ranging between 0 and 520 mm – an additional charge for each 2 cm is PLN 80, relative to the frame price of PLN 400-420 mm
- Tunnel type door frame for both rebated and non-rebated door widths of 60, 70, 80, 90, 100 are at the price of the rebated adjustable door frames.
- Tunnel type door frame for both rebated and non-rebated door widths of 110, 120, 130, 140, 150, 160, 170, 180, 190 are at the price of the adjustable door frame for rebated double-leaf doors
- Top panels glued to the wall (only for frames with 8 cm corner) - p. 134



Showroom Drag de Lemn Baneasa

Adresa: Str. Promoroaca 3A, Sector 1, Bucuresti
Telefon: 0771461001



Showroom Drag de Lemn Militari

Adresa: Str. Preciziei 3, Sector 6, Bucuresti
Telefon: 0771145113

Distribuitor in Romania: ADCA RETAIL SRL

Showroom Militari : Str. Preciziei, nr.3, sector 6, Bucuresti

Tel.: 0771.145.113 / 0771.145.120

Showroom Baneasa : Str. Promoroaca, nr.3, sector 1, Bucuresti Tel.: 0771.461.001

www.dragdelemn.ro / Email: office@dragdelemn.ro

