

# ERKADO



up interiors

CATALOGUE  
2021



up interiors

Distribuitor in Romania: ADCA RETAIL SRL

Showroom Militari : Str. Preciziei, nr.3, sector 6, Bucuresti

Tel.: 0771.145.113 / 0771.145.120

Showroom Baneasa : Str. Promoroaca, nr.3, sector 1, Bucuresti Tel.: 0771.461.001

[www.dragdelemn.ro](http://www.dragdelemn.ro) / Email: [office@dragdelemn.ro](mailto:office@dragdelemn.ro)



## ERKADO

Every house is fitted with interior doors. This is why approaching doors only from the point of view of their functionality and practicality has long been insufficient. Underlining the best qualities in a perfectly furnished house, today they are an important component of interior design. For this reason, we create modern solutions, introduce attractive design and focus on the quality of workmanship to let you enjoy the choice of the Erkado doors.

We are committed to developing all business areas relevant for creating a product that meets your expectations. We achieve this goal by investing in technologically advanced production lines, staff training and systematic analysis of consumer needs. Our dynamic development would be impossible without the activity of the sales network participants.

Thank you for your inspiring suggestions and friendly feedback.



The mark of responsible forestry  
Look for FSC® certified products

# CONTENTS

<b>STILE DOORS</b> .....	<b>6</b>
MISKANT <b>NEW</b> .....	6
LAURENCJA .....	8
SURMIA .....	10
BUDLEJA .....	12
EPIMEDIUM .....	14
ARALIA .....	16
EWODIA .....	18
NOLINA .....	20
MAGNOLIA .....	22
PODWOJNIK .....	24
JUKA <b>BEST PRICE!</b> .....	26
FORSYCJA <b>BEST PRICE!</b> .....	28
LAWENDA <b>BEST PRICE!</b> .....	30
IRYS .....	32
DAGLEZJA .....	34
FREZJA .....	36
DEBECJA .....	38
NEMEZJA <b>NEW</b> .....	40
BERBERYS .....	42
FLOKS .....	44
KROKUS .....	46
KAMELIA .....	48
PETUNIA .....	50
AZALIA .....	52
HIACYNT .....	54
FRAGI <b>NEW</b> .....	56
<b>GRAF GLASS DOORS</b> .....	<b>58</b>
<b>DECORATIVE PANELS</b> <b>NEW</b> .....	<b>60</b>
<b>LACQUERED DOORS</b> .....	<b>62</b>
UNO PREMIUM .....	62
TURAN <b>NEW</b> .....	64
MISKANT <b>NEW</b> .....	66
NEMEZJA <b>NEW</b> .....	68
LAURENCJA <b>NEW</b> .....	70
MILDA .....	72
BALDUR <b>NEW</b> .....	74
ANUBIS .....	76
SYLENA .....	78
<b>INLAYS</b> <b>NEW</b> .....	<b>80</b>
<b>FLUSH DOORS</b> .....	<b>82</b>
UNO PREMIUM .....	82
BALDUR .....	84
ALTAMURA .....	88
ANSEDONIA .....	90
LORIENT .....	92
MENTON .....	94
SORANO .....	96
<b>INTERIOR FRONT DOORS</b> .....	<b>98</b>
FORTECA RC2 .....	98
FORTECA RC3 .....	98
FIXED DOOR FRAME FOR FORTECA .....	102
STEEL DOOR FRAMES FOR FORTECA <b>NEW</b> .....	103
HERSE SET .....	104
HERSE MAX SET .....	108
FIXED AND ADJUSTABLE DOOR FRAME FOR THE HERSE SET SERIES .....	110
STEEL DOOR FRAMES FOR THE FORTECA HERSE SET SERIES .....	112
UNITED STEEL DOOR FRAME <b>NEW</b> FOR THE HERSE SET SERIES .....	113
<b>INTERIOR FIRE PROTECTION FRONT DOORS</b> .....	<b>114</b>
LEDA EI30 .....	114
LEDA EI60 .....	114
WOODEN DOOR FRAME FOR THE LEDA SERIES .....	116
STEEL DOOR FRAMES FOR THE LEDA SERIES .....	116
DOUBLE-LEAF LEDA EI30 & EI60 .....	117
HYPERION EI30 RC2 <b>NEW</b> .....	118
<b>HARDWARE – HANDLES</b> <b>NEW</b> .....	<b>120</b>
<b>TECHNICAL INFORMATION</b> .....	<b>128</b>
<b>DOOR FRAME EXTENSION PANELS</b> <b>NEW</b> .....	<b>134</b>
<b>WALL-MOUNTED SLIDING DOOR SYSTEMS</b> <b>NEW</b> .....	<b>135</b>
<b>POCKET SLIDING DOOR SYSTEMS</b> .....	<b>141</b>
<b>DOUBLE-LEAF DOORS</b> .....	<b>144</b>
<b>FOLDING DOORS</b> .....	<b>147</b>
<b>COVERT CONCEALED DOOR SYSTEM</b> <b>NEW</b> .....	<b>148</b>
<b>LIGHTING</b> .....	<b>151</b>
<b>DOOR FRAMES</b> .....	<b>153</b>
TUNNEL TYPE ADJUSTABLE DOOR FRAME .....	156
STEEL DOOR FRAME .....	157
ADJUSTABLE CASING FRAME FOR STEEL DOOR FRAMES .....	158
REVERSE DOOR FRAME .....	159
ADJUSTABLE DOOR FRAME FOR NON-REBATED DOORS .....	160
FIXED FRAME FOR REBATED DOORS <b>NEW</b> .....	161
ADJUSTABLE DOOR FRAME FOR NON-REBATED DOORS .....	162



# DECORS

COLOURS AVAILABLE FOR INTERIOR DOORS

## GREKO, FINISH



GOLDEN GREKO OAK

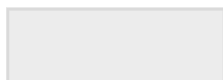

WHITE GREKO  
(similar to: RAL 9010,  
NCS S 0502-Y50R)



GREKO ELM



GREKO GREY OAK



SANREMO GREKO



GREKO WALNUT



GREKO OAK



MEDIUM GREKO OAK



GREKO SONOMA



GREKO WHITE PINE



SNOW-WHITE GREKO  
(similar to: RAL 9016,  
NCS S 0300-N)



WALNUT FINISH



ACACIA FINISH



LIGHT ACACIA FINISH

## PREMIUM



WALNUT PREMIUM



GREY MAPLE PREMIUM



OAK PREMIUM

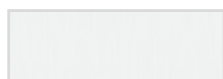

WHITE BARK PREMIUM

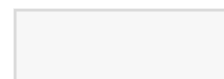

WHITE PREMIUM  
(similar to: RAL 9003,  
NCS S 0500-N)

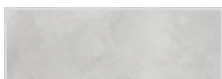

CONCRETE PREMIUM



HORIZONTAL LARCH



GRAPHITE ASH PREMIUM



**NEW**

NATUR OAK PREMIUM

## CPL



OAK ST CPL



GREY OAK ST CPL



VENGE ST CPL



GREY PINE ST CPL

**NEW**

WHITE ST CPL \*)  
(similar to: RAL 9003,  
NCS S 0500-N)



**NEW**

CAPPUCCINO ST CPL \*)  
(similar to: RAL D2 080 80 05  
NCS S3005-Y50R)



**NEW**

LIGHT-GREY ST CPL \*)  
(similar to: RAL 7037,  
NCS S 5500-N)



**NEW**

BLACK ST CPL \*)  
(similar to: RAL 9011,  
NCS S 9000-N)

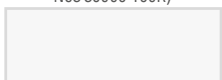

WHITE CPL 0.2 & 0.7  
(similar to: RAL 9003,  
NCS S 0300-N)

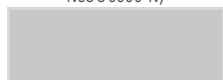

ASH-GEY CPL 0.2 & 0.7  
(similar to: RAL 7047,  
NCS S 2500-N)



ANTHRACITE CPL 0.2 & 0.7  
(similar to: RAL D2 000 35 00  
NCS S 7000-N)



OAK CPL 0.2 & 0.7 \*)

## UV-PAINTED

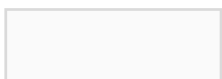

WHITE TITANIUM UV  
(similar to: RAL 9003,  
NCS S 0500-N)

Read more on decors on p. 129

\* special AntiFinger coating to reduce dirt and fingerprints



# STILE DOORS

REBATED AND NON-REBATED



Solid 35 mm or 22 mm thick rail



Aesthetic frameless tongue-and-groove glazing without bars



Attractive GREKO laminate, resistant CPL surface or PREMIUM laminate which is both good-looking and durable



RUMBA handle with antibacterial coating containing active silver ions (optionally)



Solid dowel joint



Factory-drilled holes for handle assembly (applies to the PREMIUM and ST CPL decors for handles from the so-called shared offer)



Three adjustable 2-pin hinges set in a robust 40 mm thick stile (optional sleeves)



Modern tempered and frosted or optionally: transparent and novel VSG glass - mat or black **NEW**



A drop-down gasket (alternatively)



MDF stile for the GREKO and CPL laminates with the AntiFinger coating **NEW**



Glulam wood stile for the PREMIUM and CPL laminates without the AntiFinger coating



Concealed magnetic stop (optionally) **NEW**



# MISKANT

REBATED AND NON-REBATED INTERIOR STILE DOOR LEAVES



MISKANT 2, leaf laminate NATUR OAK PREMIUM, frame laminate BLACK ST CPL, handle BELLA slim black matt



MISKANT 1



MISKANT 2



MISKANT 3



MISKANT 4



MISKANT 5



MISKANT 6

Presented model: MISKANT 2, laminate NATUR OAK PREMIUM handle CUBE



**CONSTRUCTION**

- rebated or non-rebated door leaf made in the STILE technology
- MDF board vertical stiles covered with the GREKO and CPL laminate with the AntiFinger coating and vertical glulam stiles covered with thin HDF panels and the PREMIUM or CPL laminate without the Anti-Finger coating **NEW**
- optionally, against an extra charge, upper panels extending the frame - page 134 **NEW**

**HARDWARE**

- rebated door leaves: three silver 2-pin hinges adjusted horizontally
- three concealed hinges in a non-rebated leaf, silver (optionally black - subject to an additional charge); hinges supplied with and included in the price of the door frame **NEW**
- deadbolt lock in a rebated door leaf and a key-locked magnetic lock in a non-rebated door leaf, thumb turn cylinder, economy, with a silver blockade; optionally, against an additional charge, a black, magnetic lock **NEW**

**GLAZING**

- toughened transparent or frosted glass with a thickness of 4 mm
- possibility to change the glazing side to REVERSE (OBVERSE - standard glazing)
- black lines of 18 mm in width (thickness)

**AVAILABLE SOLUTIONS** (pp. 135-143)

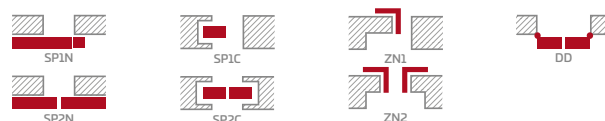

**AVAILABLE DOOR LEAF WIDTHS**

- 60
- 70
- 80
- 90
- 100

**ADDITIONAL CHARGES**

- ventilation cut
- plastic woodgrain sleeves (4 pcs)
- round and square metal sleeves (4 pcs); brushed nickel or patina finish in white or black
- ventilation grille (only for door leaf widths of 80, 90, 100) 80, 90, 100
- "100" rebated and non-rebated door leaf
- metal hinge casings in the rebated door leaf (brushed nickel, patina, polished chrome, polished brass, white and black)
- drop-down gasket <sup>2)</sup>
- can be replaced with a black magnetic lock for non-rebated door leaves
- magnetic stop (buffer) <sup>2)</sup> **NEW** (available in six colours p. 132)
- factory-drilled openings for through-mounting applies to double-section handles in our offer <sup>3)</sup> pages 120 to 127 **NEW**

**GREKO**

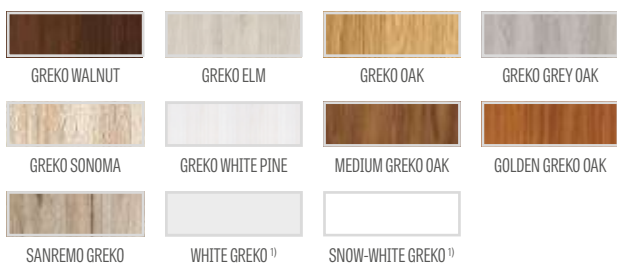

**PREMIUM**

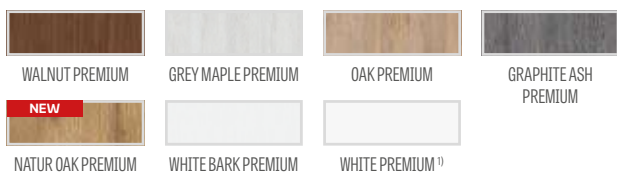

**CPL**

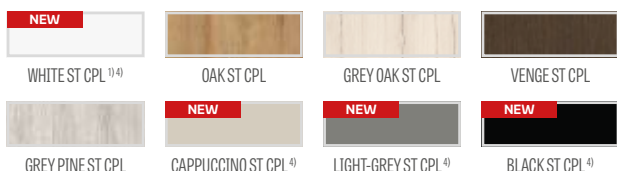

MDF stile for the GREKO and CPL laminates with the AntiFinger coating **NEW**



Glulam wood stile for the PREMIUM and CPL laminates without the AntiFinger coating

**STANDARD AWERS (OBVERSE) GLAZING**



**MADE TO ORDER "REVERSE" GLAZING**



<sup>1)</sup> plain white laminate imitating a painted surface  
<sup>2)</sup> the stop prevents application of a drop-down gasket and vice versa  
<sup>3)</sup> applies only to the PREMIUM and ST CPL decors  
<sup>4)</sup> special AntiFinger coating to reduce dirt and fingerprints



# LAURENCJA

REBATED AND NON-REBATED INTERIOR STILE DOOR LEAVES



LAURENCJA 1, PREMIUM WHITE laminate, black VSG glass, CUBE PREMIUM handle, black matt



LAURENCJA 1



LAURENCJA 2



LAURENCJA 3



LAURENCJA 4



LAURENCJA 5



LAURENCJA 6



Presented model: LAURENCJA1 with PREMIUM WHITE laminate, black matt CUBE PREMIUM handle and black VSG 221 laminated glass



## CONSTRUCTION

- rebated or non-rebated door leaf made in the STILE technology
- MDF board vertical stiles covered with the GREKO and CPL laminate with the AntiFinger coating and vertical glulam stiles covered with thin HDF panels and the PREMIUM or CPL laminate without the Anti-Finger coating **NEW**
- 4 mm thick HDF panels with CPL or PREMIUM laminate
- very wide crossbar - 35 mm
- optionally, against an extra charge, upper panels extending the frame - page 134 **NEW**

## HARDWARE

- rebated door leaves: three silver 2-pin hinges adjusted horizontally
- three concealed hinges in a non-rebated leaf, silver (optionally black - subject to an additional charge); hinges supplied with and included in the price of the door frame **NEW**
- deadbolt lock in a rebated door leaf and a key-locked magnetic lock in a non-rebated door leaf, thumb turn cylinder, economy, with a silver blockade; optionally, against an additional charge, a black, magnetic lock **NEW**

## GLAZING

- tempered 4 mm glass, frosted or transparent as a standard and, against an additional charge, laminated VSG 221 safety glass frosted or black **NEW** plain on both sides
- possibility to change the glazing side to REVERSE (OBSERVE - standard glazing)

## AVAILABLE SOLUTIONS (pp. 135-143)

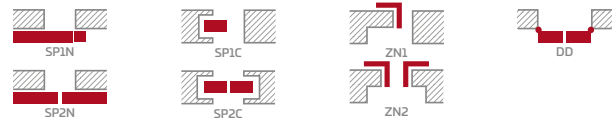

## AVAILABLE DOOR LEAF WIDTHS

60 70 80 90 100

## ADDITIONAL CHARGES

ventilation cut

plastic woodgrain sleeves (4 pcs)

round and square metal sleeves (4 pcs);  
brushed nickel or patina finish in white or black

ventilation grille (only for door leaf widths of 80, 90, 100) 80, 90, 100

"100" rebated and non-rebated door leaf

frosted or black VSG 221 laminated safety glass, **NEW**  
plain on both sides

metal hinge casings in rebated door leaf  
(colour: brushed nickel, patina, glossy chrome, glossy brass, white and black)

drop-down gasket <sup>2)</sup>

can be replaced with a black magnetic lock for non-rebated door leaves

magnetic stop (buffer) <sup>2)</sup> **NEW**  
(available in six colours p. 132)

factory-drilled openings for through-mounting applies to double-section handles in our offer - pages 120 to 127 **NEW**

### PREMIUM

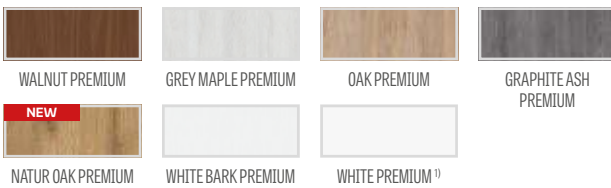

### CPL

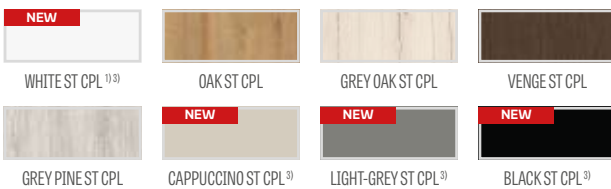

MDF stile for CPL laminates with the AntiFinger coating **NEW**



Glulam wood stile for the PREMIUM and CPL laminates without the AntiFinger coating

<sup>1)</sup> plain white laminate imitating a painted surface

<sup>2)</sup> the stop prevents application of a drop-down gasket and vice versa

<sup>3)</sup> special AntiFinger coating to reduce dirt and fingerprints



# SURMIA

REBATED AND NON-REBATED INTERIOR STILE DOOR LEAVES



SURMIA 1, WENGE ST CPL laminate, CUBE handle - bushed chrome, mat



SURMIA 1



SURMIA 2



SURMIA 3



SURMIA 4

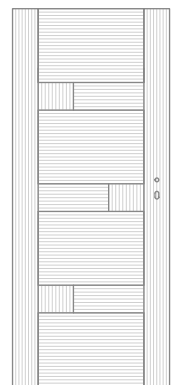

GRAIN PATTERN <sup>\*)</sup>

Presented model: SURMIA 1 in VENGE ST CPL finish with matt brushed chrome CUBE handle



## CONSTRUCTION

- rebated or non-rebated door leaf made in the STILE technology
- MDF board vertical stiles covered with the GREKO and CPL laminate with the AntiFinger coating and vertical glulam stiles covered with thin HDF panels and the PREMIUM or CPL laminate without the Anti-Finger coating **NEW**
- 22 mm and 4 mm thick HDF panels with CPL or PREMIUM finish
- 35 mm thick, very wide crossbar
- optionally, against an extra charge, upper panels extending the frame - page 134 **NEW**

## HARDWARE

- rebated door leaves: three silver 2-pin hinges adjusted horizontally
- three concealed hinges in a non-rebated leaf, silver (optionally black - subject to an additional charge); hinges supplied with and included in the price of the door frame **NEW**
- deadbolt lock in a rebated door leaf and a key-locked magnetic lock in a non-rebated door leaf, thumb turn cylinder, economy, with a silver blockade; optionally, against an additional charge, a black, magnetic lock **NEW**

## GLAZING

- 4 mm frosted or transparent tempered glass as standard, and, against an additional charge, VSG 221 laminated safety glass, frosted, plain on both sides
- possibility to change the glazing side to REVERSE (OBSERVE - standard glazing)

## AVAILABLE SOLUTIONS (pp. 135-143)

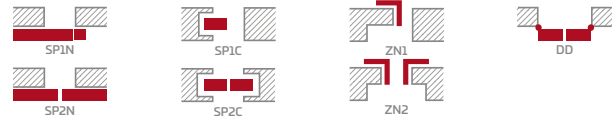

## AVAILABLE DOOR LEAF WIDTHS

60 70 80 90 100

## ADDITIONAL CHARGES

ventilation cut

plastic woodgrain sleeves (4 pcs)

round and square metal sleeves (4 pcs);  
brushed nickel or patina finish in white or black

ventilation grille (only for door leaf widths of 80, 90, 100) 80, 90, 100

"100" rebated and non-rebated door leaf

frosted VSG 221 laminated safety glass, plain on both sides

metal hinge casings in rebated door leaf  
(colour: brushed nickel, patina, glossy chrome, glossy brass, white and black)

drop-down gasket <sup>2)</sup>

can be replaced with a black magnetic lock for non-rebated door leaves

magnetic stop (buffer) <sup>2)</sup> **NEW**  
(available in six colours p. 132)

factory-drilled openings for through-mounting applies to double-section handles in our offer - pages 120 to 127 **NEW**

### PREMIUM

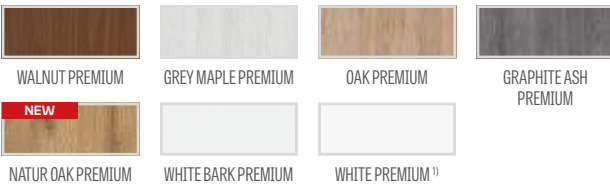

### CPL

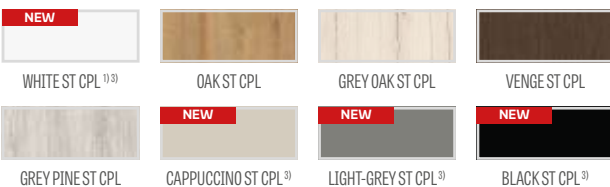

MDF stile for CPL laminates with the AntiFinger coating **NEW**

Glulam wood stile for the PREMIUM and CPL laminates without the AntiFinger coating

<sup>1)</sup> plain white laminate imitating a painted surface

<sup>2)</sup> the stop prevents application of a drop-down gasket and vice versa

<sup>3)</sup> special AntiFinger coating to reduce dirt and fingerprints



# BUDLEJA

REBATED AND NON-REBATED INTERIOR STILE DOOR LEAVES



BUDLEJA 2, OAK ST CPL laminate, TOPAZ INOX handle



BUDLEJA 1



BUDLEJA 2



BUDLEJA 3



BUDLEJA 4



BUDLEJA 5



BUDLEJA 6



BUDLEJA 7



BUDLEJA 8

Presented model: BUDLEJA 1 in OAK ST CPL finish with TOPAZ INOX handle



## CONSTRUCTION

- rebated or non-rebated door leaf made in the STILE technology
- MDF board vertical stiles covered with the GREKO and CPL laminate with the AntiFinger coating and vertical glulam stiles covered with thin HDF panels and the PREMIUM or CPL laminate without the Anti-Finger coating **NEW**
- very wide crossbar - 35 mm
- optionally, against an extra charge, upper panels extending the frame - page 134 **NEW**

## HARDWARE

- rebated door leaves: three silver 2-pin hinges adjusted horizontally
- three concealed hinges in a non-rebated leaf, silver (optionally black - subject to an additional charge); hinges supplied with and included in the price of the door frame **NEW**
- deadbolt lock in a rebated door leaf and a key-locked magnetic lock in a non-rebated door leaf, thumb turn cylinder, economy, with a silver blockade; optionally, against an additional charge, a black, magnetic lock **NEW**

## GLAZING

- tempered 4 mm glass, frosted or transparent as a standard and, against an additional charge, laminated VSG 221 safety glass frosted or black **NEW** plain on both sides
- possibility to change the glazing side to REVERSE (OBSERVE - standard glazing)

## AVAILABLE SOLUTIONS (pp. 135-143)

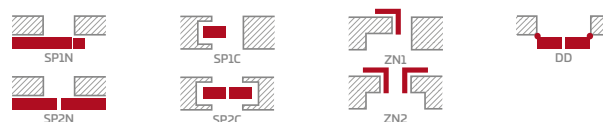

## AVAILABLE DOOR LEAF WIDTHS

60 70 80 90 100

## ADDITIONAL CHARGES

- ventilation cut
- plastic woodgrain sleeves (4 pcs)
- round and square metal sleeves (4 pcs); brushed nickel or patina finish in white or black
- ventilation grille (only for door leaf widths of 80, 90, 100)
- "100" rebated and non-rebated door leaf
- frosted or black VSG 221 laminated safety glass, **NEW** plain on both sides
- metal hinge casings in rebated door leaf (colour: brushed nickel, patina, glossy chrome, glossy brass, white and black)
- drop-down gasket <sup>2)</sup>
- can be replaced with a black magnetic lock for non-rebated door leaves
- magnetic stop (buffer) <sup>2)</sup> **NEW** (available in six colours p. 132)
- factory-drilled openings for through-mounting applies to double-section handles in our offer - pages 120 to 127 **NEW**

### PREMIUM

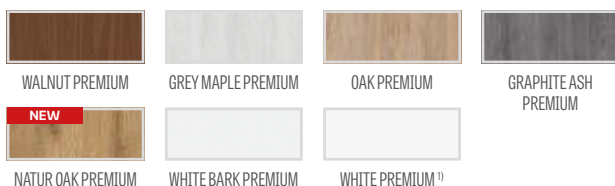

### CPL

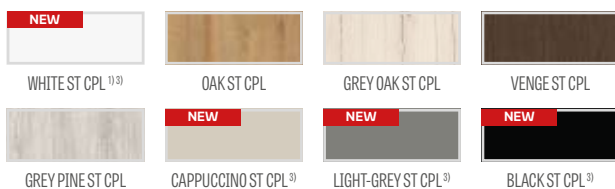

MDF stile for CPL laminates with the AntiFinger coating **NEW**



Glulam wood stile for the PREMIUM and CPL laminates without the AntiFinger coating

<sup>1)</sup> plain white laminate imitating a painted surface

<sup>2)</sup> the stop prevents application of a drop-down gasket and vice versa

<sup>3)</sup> special AntiFinger coating to reduce dirt and fingerprints



# EPIMEDIUM

REBATED AND NON-REBATED INTERIOR STILE DOOR LEAVES



EPIMEDIUM 4, laminate GRAFIT PREMIUM ASH, CUBE handle, brushed chrome, matt

WIDTH 80



EPIMEDIUM 1<sup>\*)</sup>



EPIMEDIUM 2<sup>\*)</sup>



EPIMEDIUM 3<sup>\*)</sup>



EPIMEDIUM 4<sup>\*)</sup>



EPIMEDIUM 5<sup>\*)</sup>

WIDTH 70

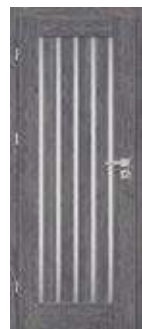

EPIMEDIUM 1<sup>\*)</sup>



EPIMEDIUM 2<sup>\*)</sup>



EPIMEDIUM 3<sup>\*)</sup>



EPIMEDIUM 4<sup>\*)</sup>



EPIMEDIUM 5<sup>\*)</sup>

<sup>\*)</sup> The pictures show only the EPIMEDIUM doors with 80 and 70 cm wide leaves.

The glazing to vertical bars ratio in the other width options differs considerably, which can be the key factor regarding the customer's product choice.

For the other width options go to [www.erkado.pl](http://www.erkado.pl)

Presented model: EPIMEDIUM i in GRAPHITE PREMIUM finish with matt brushed chrome CUBE handle



## CONSTRUCTION

- rebated or non-rebated door leaf made in the STILE technology
- MDF board vertical stiles covered with the GREKO and CPL laminate with the AntiFinger coating and vertical glulam stiles covered with thin HDF panels and the PREMIUM or CPL laminate without the Anti-Finger coating **NEW**
- 4 mm thick HDF panels with GREKO, CPL or PREMIUM finish
- narrow, long crossbar of 22 mm
- optionally, against an extra charge, upper panels extending the frame - page 134 **NEW**

## HARDWARE

- rebated door leaves: three silver 2-pin hinges adjusted horizontally
- three concealed hinges in a non-rebated leaf, silver (optionally black - subject to an additional charge); hinges supplied with and included in the price of the door frame **NEW**
- deadbolt lock in a rebated door leaf and a key-locked magnetic lock in a non-rebated door leaf, thumb turn cylinder, economy, with a silver blockade; optionally, against an additional charge, a black, magnetic lock **NEW**

## GLAZING

- 4 mm frosted or transparent tempered glass as standard, and, against an additional charge, VSG 221 laminated safety glass, frosted, plain on both sides
- possibility to change the glazing side to REVERSE (OBSERVE - standard glazing)
- depending on the leaf width, the glazing widths differ. Check at [www.erkado.pl](http://www.erkado.pl)

## AVAILABLE SOLUTIONS (pp. 135-143)

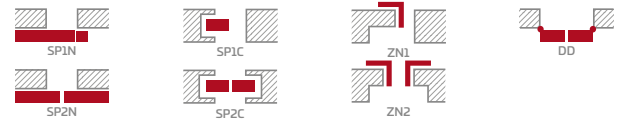

## AVAILABLE DOOR LEAF WIDTHS

60 70 80 90 100

## ADDITIONAL CHARGES

- ventilation cut
- plastic woodgrain sleeves (4 pcs)
- round and square metal sleeves (4 pcs); brushed nickel or patina finish in white or black
- ventilation grille (only for door leaf widths of 80, 90, 100)
- "100" rebated and non-rebated door leaf
- frosted VSG 221 laminated safety glass, plain on both sides
- metal hinge casings in the rebated door leaf (brushed nickel, patina, polished chrome, polished brass, white and black);
- drop-down gasket <sup>2)</sup>
- can be replaced with a black magnetic lock for non-rebated door leaves
- magnetic stop (buffer) <sup>2)</sup> **NEW** (available in six colours p. 132)
- factory-drilled openings for through-mounting applies to double-section handles in our offer <sup>3)</sup> pages 120 to 127 **NEW**

### GREKO

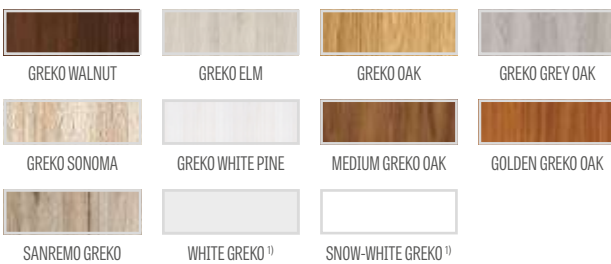

### PREMIUM

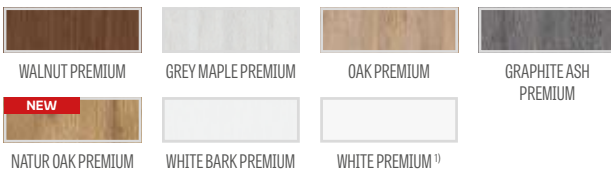

### CPL

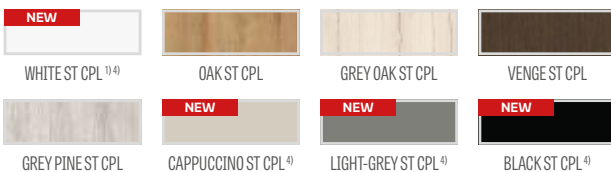

MDF stile for the GREKO and CPL laminates with the AntiFinger coating **NEW**



Glulam wood stile for the PREMIUM and CPL laminates without the AntiFinger coating

<sup>1)</sup> plain white laminate imitating a painted surface

<sup>2)</sup> the stop prevents application of a drop-down gasket and vice versa

<sup>3)</sup> applies only to the PREMIUM and ST CPL decors

<sup>4)</sup> special AntiFinger coating to reduce dirt and fingerprints



# ARALIA

REBATED AND NON-REBATED INTERIOR STILE DOOR LEAVES



ARALIA 2, laminate WHITE PREMIUM BARK, handle RUMBA antibacterial, black



ARALIA 1



ARALIA 2



ARALIA 3



Presented model: ARALIA 1 in WHITE BARK PREMIUM finish with TOPAZ INOX handle



## CONSTRUCTION

- rebated or non-rebated door leaf made in the STILE technology
- timber stiles covered with thin HDF boards and with PREMIUM surface
- 16 mm thick HDF panels with PREMIUM finish (vertical grain direction)
- optionally, against an extra charge, upper panels extending the frame - page 134 **NEW**

## HARDWARE

- rebated door leaves: three silver 2-pin hinges adjusted horizontally
- three concealed hinges in a non-rebated leaf, silver (optionally black - subject to an additional charge); hinges supplied with and included in the price of the door frame **NEW**
- deadbolt lock in a rebated door leaf and a key-locked magnetic lock in a non-rebated door leaf, thumb turn cylinder, economy, with a silver blockade; optionally, against an additional charge, a black, magnetic lock **NEW**

## GLAZING

- frosted decor mat glass 4 mm or custom-made frosted VSG 221 laminated safety glass, plain on both sides, against an additional charge
- possibility to change the glazing side to REVERSE (OBVERSE - standard glazing)

## AVAILABLE SOLUTIONS (pp. 135-143)

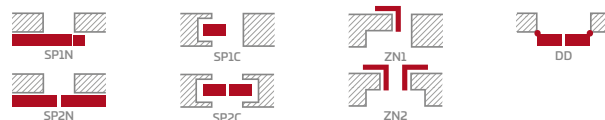

## AVAILABLE DOOR LEAF WIDTHS

60 70 80 90 100

## ADDITIONAL CHARGES

ventilation cut

plastic woodgrain sleeves (4 pcs)

round and square metal sleeves (4 pcs);  
brushed nickel or patina finish in white or black

ventilation grille (only for door leaf widths of 80, 90, 100)

"100" rebated and non-rebated door leaf

frosted VSG 221 laminated safety glass, plain on both sides

metal hinge casings in rebated door leaf  
(colour: brushed nickel, patina, glossy chrome, glossy brass, white and black)

drop-down gasket <sup>1)</sup>

can be replaced with a black magnetic lock for non-rebated door leaves

magnetic stop (buffer) <sup>1)</sup> **NEW**  
(available in six colours p. 132)

factory-drilled openings for through-mounting applies to double-section handles in our offer - pages 120 to 127 **NEW**

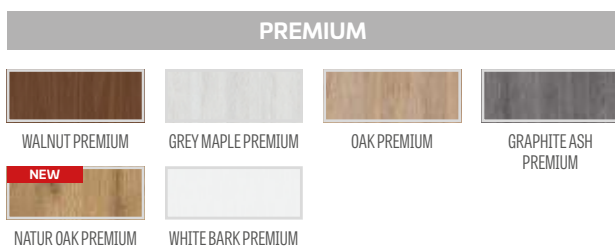

Glulam timber stile for PREMIUM and CPL laminates

<sup>1)</sup> the stop prevents application of a drop-down gasket and vice versa



# EWODIA

REBATED AND NON-REBATED INTERIOR STILE DOOR LEAVES



EWODIA 4, OAK PREMIUM laminate, round matt brushed chrome LUNA PREMIUM handle



EWODIA 1



EWODIA 2



EWODIA 3



EWODIA 4

Presented model: EWODIA 1 in OAK PREMIUM finish with round matt brushed chrome LUNA PREMIUM handle

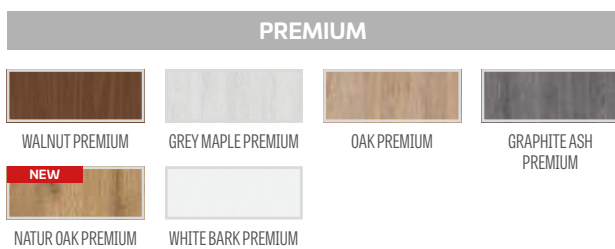

Glulam timber stile for PREMIUM and CPL laminates

## CONSTRUCTION

- rebated or non-rebated door leaf made in the STILE technology
- timber stiles covered with thin HDF boards and with PREMIUM surface
- 16 mm thick HDF panels with PREMIUM finish (vertical grain direction)
- optionally, against an extra charge, upper panels extending the frame - page 134 **NEW**

## HARDWARE

- rebated door leaves: three silver 2-pin hinges adjusted horizontally
- three concealed hinges in a non-rebated leaf, silver (optionally black - subject to an additional charge); hinges supplied with and included in the price of the door frame **NEW**
- deadbolt lock in a rebated door leaf and a key-locked magnetic lock in a non-rebated door leaf, thumb turn cylinder, economy, with a silver blockade; optionally, against an additional charge, a black, magnetic lock **NEW**

## GLAZING

- frosted decor mat glass 4 mm or custom-made frosted VSG 221 laminated safety glass, plain on both sides, against an additional charge
- possibility to change the glazing side to REVERSE (OBVERSE - standard glazing)

## AVAILABLE SOLUTIONS (pp. 135-143)

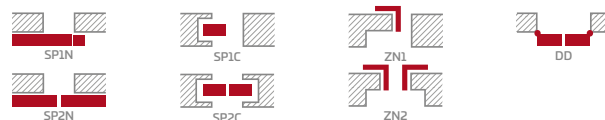

## AVAILABLE DOOR LEAF WIDTHS

60 70 80 90 100

## ADDITIONAL CHARGES

ventilation cut

plastic woodgrain sleeves (4 pcs)

round and square metal sleeves (4 pcs);  
brushed nickel or patina finish in white or black

ventilation grille (only for door leaf widths of 80, 90, 100)

"100" rebated and non-rebated door leaf

frosted VSG 221 laminated safety glass, plain on both sides

metal hinge casings in rebated door leaf  
(colour: brushed nickel, patina, glossy chrome, glossy brass, white and black)

drop-down gasket <sup>1)</sup>

can be replaced with a black magnetic lock for non-rebated door leaves

magnetic stop (buffer) <sup>1)</sup> **NEW**  
(available in six colours p. 132)

factory-drilled openings for through-mounting applies to double-section handles in our offer - pages 120 to 127 **NEW**

<sup>1)</sup> the stop prevents application of a drop-down gasket and vice versa



# NOLINA

REBATED AND NON-REBATED INTERIOR STILE DOOR LEAVES



NOLINA 1, laminate GREY PREMIUM MAPLE, TOPAZ INOX handle



NOLINA 1



NOLINA 2



NOLINA 3

Presented model: NOLINA 1 in GREY MAPLE PREMIUM finish with TOPAZ INOX handle



## CONSTRUCTION

- rebated or non-rebated door leaf made in the STILE technology
- timber stiles covered with thin HDF boards and with PREMIUM surface
- 16 mm thick HDF panels with PREMIUM finish (vertical grain direction)
- optionally, against an extra charge, upper panels extending the frame - page 134 **NEW**

## HARDWARE

- rebated door leaves: three silver 2-pin hinges adjusted horizontally
- three concealed hinges in a non-rebated leaf, silver (optionally black - subject to an additional charge); hinges supplied with and included in the price of the door frame **NEW**
- deadbolt lock in a rebated door leaf and a key-locked magnetic lock in a non-rebated door leaf, thumb turn cylinder, economy, with a silver blockade; optionally, against an additional charge, a black, magnetic lock **NEW**

## GLAZING

- frosted decor mat glass 4 mm or custom-made frosted VSG 221 laminated safety glass, plain on both sides, against an additional charge
- possibility to change the glazing side to REVERSE (OBVERSE - standard glazing)

## AVAILABLE SOLUTIONS (pp. 135-143)

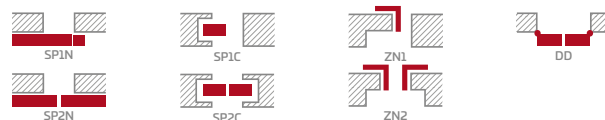

## AVAILABLE DOOR LEAF WIDTHS

60 70 80 90 100

## ADDITIONAL CHARGES

ventilation cut

plastic woodgrain sleeves (4 pcs)

round and square metal sleeves (4 pcs);  
brushed nickel or patina finish in white or black

ventilation grille (only for door leaf widths of 80, 90, 100)

"100" rebated and non-rebated door leaf

frosted VSG 221 laminated safety glass, plain on both sides

metal hinge casings in rebated door leaf  
(colour: brushed nickel, patina, glossy chrome, glossy brass, white and black)

drop-down gasket <sup>1)</sup>

can be replaced with a black magnetic lock for non-rebated door leaves

magnetic stop (buffer) <sup>1)</sup> **NEW**  
(available in six colours p. 132)

factory-drilled openings for through-mounting applies to double-section handles in our offer - pages 120 to 127 **NEW**

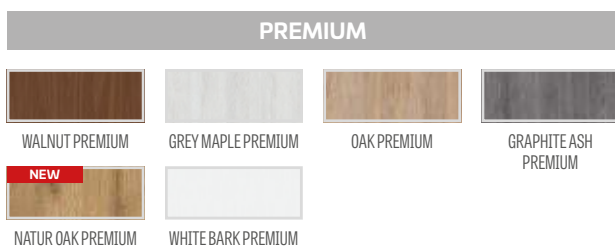

Glulam timber stile for PREMIUM and CPL laminates

<sup>1)</sup> the stop prevents application of a drop-down gasket and vice versa



# MAGNOLIA

REBATED AND NON-REBATED INTERIOR STILE DOOR LEAVES



MAGNOLIA 1, laminate GREKO NUT; DECO handle



MAGNOLIA 1



MAGNOLIA 2



MAGNOLIA 3



MAGNOLIA 4



MAGNOLIA 5



MAGNOLIA 6



MAGNOLIA 7



MAGNOLIA 8

Presented model: MAGNOLIA 1 in GREKO WALNUT finish with DECO handle



### GREKO

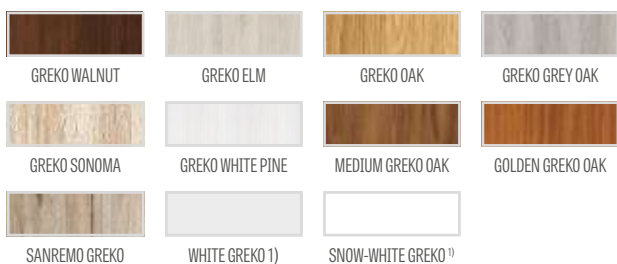

### PREMIUM

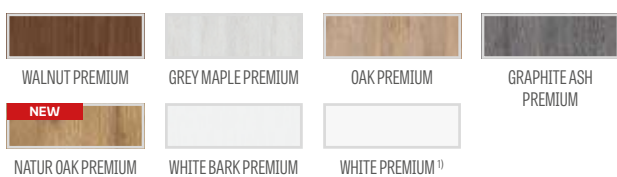

### CPL

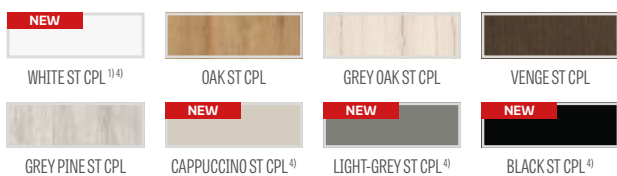

MDF stile for the GREKO and CPL laminates with the AntiFinger coating **NEW**



Glulam wood stile for the PREMIUM and CPL laminates without the AntiFinger coating

## CONSTRUCTION

- rebated or non-rebated door leaf made in the STILE technology
- MDF board vertical stiles covered with the GREKO and CPL laminate with the AntiFinger coating and vertical glulam stiles covered with thin HDF panels and the PREMIUM or CPL laminate without the Anti-Finger coating **NEW**
- 4 mm thick HDF panels with GREKO, CPL or PREMIUM finish
- optionally, against an extra charge, upper panels extending the frame - page 134 **NEW**

## HARDWARE

- rebated door leaves: three silver 2-pin hinges adjusted horizontally
- three concealed hinges in a non-rebated leaf, silver (optionally black - subject to an additional charge); hinges supplied with and included in the price of the door frame **NEW**
- deadbolt lock in a rebated door leaf and a key-locked magnetic lock in a non-rebated door leaf, thumb turn cylinder, economy, with a silver blockade; optionally, against an additional charge, a black, magnetic lock **NEW**

## GLAZING

- tempered 4 mm glass, frosted or transparent as a standard and, against an additional charge, laminated VSG 221 safety glass frosted or black **NEW** plain on both sides
- possibility to change the glazing side to REVERSE (OBSERVE - standard glazing)

## AVAILABLE SOLUTIONS (pp. 135-143)

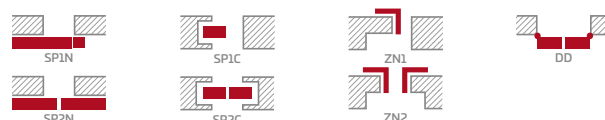

## AVAILABLE DOOR LEAF WIDTHS

60 70 80 90 100

## ADDITIONAL CHARGES

ventilation cut

plastic woodgrain sleeves (4 pcs)

round and square metal sleeves (4 pcs);  
brushed nickel or patina finish in white or black

ventilation grille (only for door leaf widths of 80, 90, 100)

"100" rebated and non-rebated door leaf

frosted or black VSG 221 laminated safety glass, **NEW**  
plain on both sides

metal hinge casings in rebated door leaf  
(colour: brushed nickel, patina, glossy chrome, glossy brass, white and black)

drop-down gasket 2)

can be replaced with a black magnetic lock for non-rebated door leaves

magnetic stop (buffer) 2) **NEW**  
(available in six colours p. 132)

factory-drilled openings for through-mounting applies to double-section in our offer 3), pages 120 to 127 **NEW**

<sup>1)</sup> plain white laminate imitating a painted surface

<sup>2)</sup> the stop prevents application of a drop-down gasket and vice versa

<sup>3)</sup> applies only to the PREMIUM and ST CPL decors

<sup>4)</sup> special AntiFinger coating to reduce dirt and fingerprints



# PODWOJNIK

REBATED AND NON-REBATED INTERIOR STILE DOOR LEAVES



PODWOJNIK 5, laminate GREY OAK ST CPL, TOPAZ INOX handle



PODWOJNIK 1



PODWOJNIK 2



PODWOJNIK 3



PODWOJNIK 4



PODWOJNIK 5



Presented model: PODWOJNIK 1, GREY OAK ST CPL laminate with a TOPAZ INOX handle



## CONSTRUCTION

- rebated or non-rebated door leaf made in the STILE technology
- MDF board vertical stiles covered with the GREKO and CPL laminate with the AntiFinger coating and vertical glulam stiles covered with thin HDF panels and the PREMIUM or CPL laminate without the Anti-Finger coating **NEW**
- 4 mm thick HDF panels with CPL or PREMIUM laminate
- central crossbars of 22 mm in thickness and a very wide upper and bottom crossbar of 35 mm
- optionally, against an additional charge, upper panels extending the frame - page 134 **NEW**

## HARDWARE

- rebated door leaves: three silver 2-pin hinges adjusted horizontally
- three concealed hinges in a non-rebated leaf, silver (optionally black - subject to an additional charge); hinges supplied with and included in the price of the door frame **NEW**
- deadbolt lock in a rebated door leaf and a key-locked magnetic lock in a non-rebated door leaf, thumb turn cylinder, economy, with a silver blockade; optionally, against an additional charge, a black, magnetic lock **NEW**

## GLAZING

- 4 mm frosted or transparent tempered glass as standard, and, against an additional charge, VSG 221 laminated safety glass, frosted, plain on both sides
- possibility to change the glazing side to REVERSE (OBSERVE - standard glazing)

## AVAILABLE SOLUTIONS (pp. 135-143)

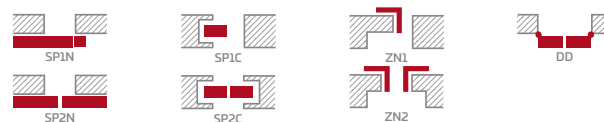

## AVAILABLE DOOR LEAF WIDTHS

60 70 80 90 100

## ADDITIONAL CHARGES

ventilation cut

plastic woodgrain sleeves (4 pcs)

round and square metal sleeves (4 pcs);  
brushed nickel or patina finish in white or black

ventilation grille (only for door leaf widths of 80, 90, 100)

"100" rebated and non-rebated door leaf

frosted VSG 221 laminated safety glass, plain on both sides

metal hinge casings in rebated door leaf  
(colour: brushed nickel, patina, glossy chrome, glossy brass, white and black)

drop-down gasket <sup>2)</sup>

can be replaced with a black magnetic lock for non-rebated door leaves

magnetic stop (buffer) <sup>2)</sup> **NEW**  
(available in six colours p. 132)

factory-drilled openings for through-mounting applies to double-section handles in our offer <sup>3)</sup> pages 120 to 127 **NEW**

### PREMIUM

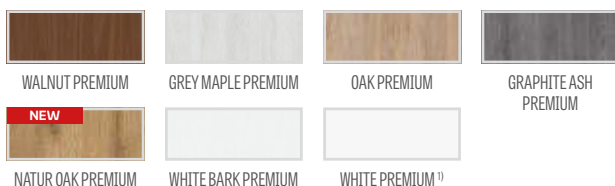

### CPL

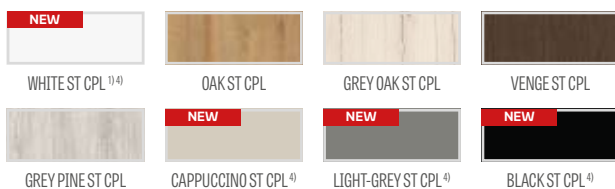

MDF stile for CPL laminates with the AntiFinger coating **NEW**



Glulam wood stile for the PREMIUM and CPL laminates without the AntiFinger coating

<sup>1)</sup> plain white laminate imitating a painted surface

<sup>2)</sup> the stop prevents application of a drop-down gasket and vice versa

<sup>3)</sup> applies only to the PREMIUM and ST CPL decors

<sup>4)</sup> special AntiFinger coating to reduce dirt and fingerprints



# JUKA

REBATED AND NON-REBATED INTERIOR STILE DOOR LEAVES



JUKA 4, laminate MEDIUM GREKO OAK, TOPAZ INOX handle



JUKA 1



JUKA 2



JUKA 3



JUKA 4



JUKA 5



JUKA 6



JUKA 7



JUKA 8

Presented model: JUUKA 1 with MEDIUM GREKO OAK laminate and a TOPPAZ INOX handle



**CONSTRUCTION**

- rebated or non-rebated door leaf made in the STILE technology
- MDF board vertical stiles covered with the GREKO and CPL laminate with the AntiFinger coating and vertical glulam stiles covered with thin HDF panels and the PREMIUM or CPL laminate without the Anti-Finger coating **NEW**
- 4 mm thick HDF panels with GREKO, CPL or PREMIUM finish
- optionally, against an additional charge, upper panels extending the frame - page 134 **NEW**

**HARDWARE**

- rebated door leaves: three silver 2-pin hinges adjusted horizontally
- three concealed hinges in a non-rebated leaf, silver (optionally black - subject to an additional charge); hinges supplied with and included in the price of the door frame **NEW**
- deadbolt lock in a rebated door leaf and a key-locked magnetic lock in a non-rebated door leaf, thumb turn cylinder, economy, with a silver blockade; optionally, against an additional charge, a black, magnetic lock **NEW**

**GLAZING**

- tempered 4 mm glass, frosted or transparent as a standard and, against an additional charge, laminated VSG 221 safety glass frosted or black **NEW** plain on both sides
- possibility to change the glazing side to REVERSE (OBSERVE - standard glazing)

**AVAILABLE SOLUTIONS** (pp. 135-143)

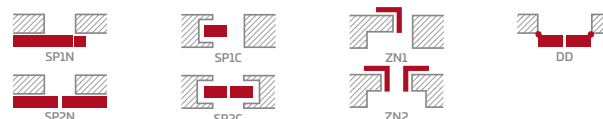

**AVAILABLE DOOR LEAF WIDTHS**



**ADDITIONAL CHARGES**

- ventilation cut
- plastic woodgrain sleeves (4 pcs)
- round and square metal sleeves (4 pcs.); finish: brushed nickel, patina white and black
- ventilation grille (only for door leaf widths of 80, 90, 100)
- "100" rebated and non-rebated door leaf
- frosted or black VSG 221 laminated safety glass, **NEW** plain on both sides
- metal hinge casings in the rebated door leaf (brushed nickel, patina, polished chrome, polished brass, white and black)
- drop-down gasket <sup>2)</sup>
- can be replaced with a black magnetic lock for non-rebated door leaves
- magnetic stop (buffer) <sup>2)</sup> **NEW** (available in six colours p. 132)
- factory-drilled openings for through-mounting applies to double-section handles in our offer <sup>3)</sup>, pages 120 to 127 **NEW**

**GREKO**

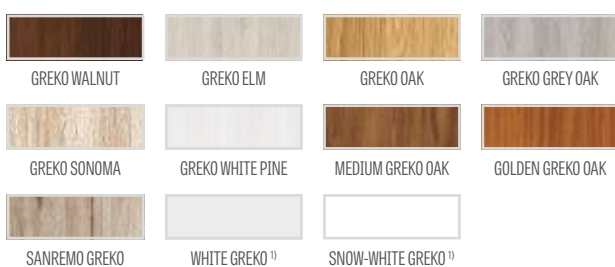

**PREMIUM**

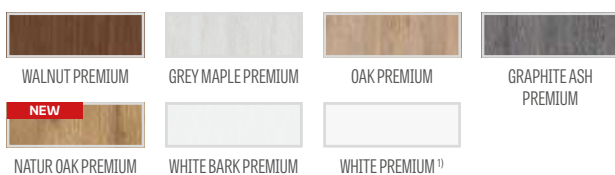

**CPL**

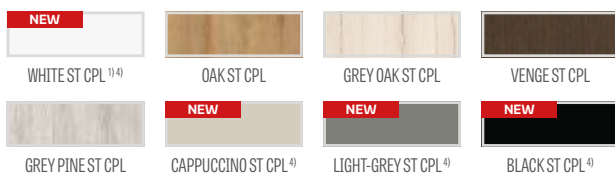

MDF stile for the GREKO and CPL laminates with the AntiFinger coating **NEW**



Glulam wood stile for the PREMIUM and CPL laminates without the AntiFinger coating

<sup>1)</sup> plain white laminate imitating a painted surface

<sup>2)</sup> the stop prevents application of a drop-down gasket and vice versa

<sup>3)</sup> applies only to the PREMIUM and ST CPL decors

<sup>4)</sup> special AntiFinger coating to reduce dirt and fingerprints



# FORSYCJA

REBATED AND NON-REBATED INTERIOR STILE DOOR LEAVES



FORSYCJA 1, door-leaf laminate WHITE GREKO, door-frame laminate OAK PREMIUM, handle: BELLA slim, black matt



FORSYCJA 1



FORSYCJA 2



FORSYCJA 3



FORSYCJA 4



FORSYCJA 5



FORSYCJA 6



FORSYCJA 7



FORSYCJA 8

Presented model: FORSYCJA 4 with WHITE GREKO laminate and a black matt CUBE handle



**CONSTRUCTION**

- rebated or non-rebated door leaf made in the STILE technology
- MDF board vertical stiles covered with the GREKO and CPL laminate with the AntiFinger coating and vertical glulam stiles covered with thin HDF panels and the PREMIUM or CPL laminate without the Anti-Finger coating **NEW**
- 4 mm thick HDF panels with GREKO, CPL or PREMIUM finish
- optionally, against an additional charge, upper panels extending the frame - page 134 **NEW**

**HARDWARE**

- rebated door leaves: three silver 2-pin hinges adjusted horizontally
- three concealed hinges in a non-rebated leaf, silver (optionally black - subject to an additional charge); hinges supplied with and included in the price of the door frame **NEW**
- deadbolt lock in a rebated door leaf and a key-locked magnetic lock in a non-rebated door leaf, thumb turn cylinder, economy, with a silver blockade; optionally, against an additional charge, a black, magnetic lock **NEW**

**GLAZING**

- tempered 4 mm glass, frosted or transparent as a standard and, against an additional charge, laminated VSG 221 safety glass frosted or black **NEW** plain on both sides
- possibility to change the glazing side to REVERSE (OBSERVE - standard glazing)

**AVAILABLE SOLUTIONS** (pp. 135-143)

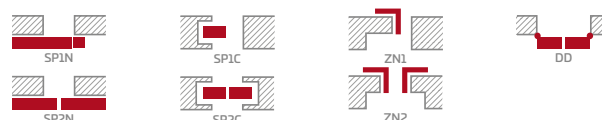

**AVAILABLE DOOR LEAF WIDTHS**



**ADDITIONAL CHARGES**

- ventilation cut
- plastic woodgrain sleeves (4 pcs)
- round and square metal sleeves (4 pcs); brushed nickel or patina finish in white or black
- ventilation grille (only for door leaf widths of 80, 90, 100)
- "100" rebated and non-rebated door leaf
- frosted or black VSG 221 laminated safety glass, **NEW** plain on both sides
- metal hinge casings in the rebated door leaf (brushed nickel, patina, polished chrome, polished brass, white and black)
- drop-down gasket <sup>2)</sup>
- can be replaced with a black magnetic lock for non-rebated door leaves
- magnetic stop (buffer) <sup>2)</sup> **NEW** (available in six colours p. 132)
- factory-drilled openings for through-mounting applies to double-section handles in our offer <sup>3)</sup>, pages 120 to 127 **NEW**

**GREKO**

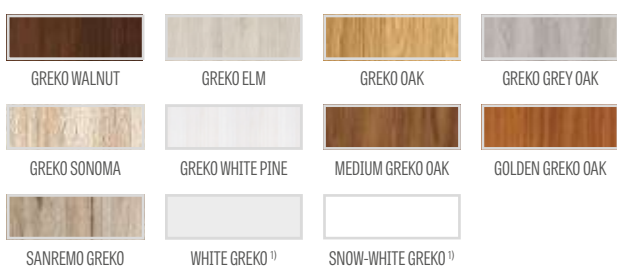

**PREMIUM**

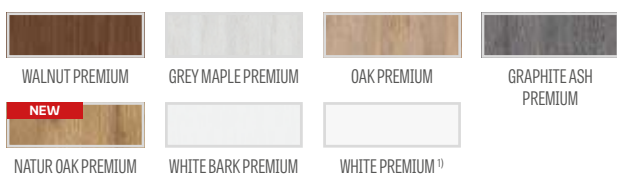

**CPL**

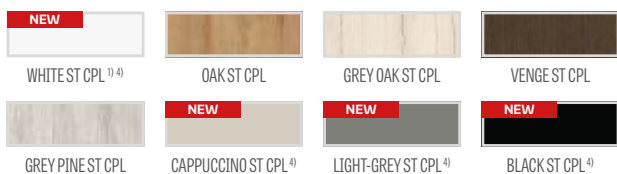

MDF stile for the GREKO and CPL laminates with the AntiFinger coating **NEW**



Glulam wood stile for the PREMIUM and CPL laminates without the AntiFinger coating

<sup>1)</sup> plain white laminate imitating a painted surface

<sup>2)</sup> the stop prevents application of a drop-down gasket and vice versa

<sup>3)</sup> applies only to the PREMIUM and ST CPL decors

<sup>4)</sup> special AntiFinger coating to reduce dirt and fingerprints



# LAWENDA

REBATED AND NON-REBATED INTERIOR STILE DOOR LEAVES



LAWENDA 7, laminate GREKO OAK, DECO handle



LAWENDA 1



LAWENDA 2



LAWENDA 3



LAWENDA 4



LAWENDA 5



LAWENDA 6



LAWENDA 7



LAWENDA 8



LAWENDA 9

Presented model: LAWENDA 1 with GREKO OAK laminate and a DECO handle



**CONSTRUCTION**

- rebated or non-rebated door leaf made in the STILE technology
- MDF board vertical stiles covered with the GREKO and CPL laminate with the AntiFinger coating and vertical glulam stiles covered with thin HDF panels and the PREMIUM or CPL laminate without the Anti-Finger coating **NEW**
- 4 mm thick HDF panels with GREKO, CPL or PREMIUM laminate
- optionally, against an additional charge, upper panels extending the frame - page 134 **NEW**

**HARDWARE**

- rebated door leaves: three silver 2-pin hinges adjusted horizontally
- three concealed hinges in a non-rebated leaf, silver (optionally black - subject to an additional charge); hinges supplied with and included in the price of the door frame **NEW**
- deadbolt lock in a rebated door leaf and a key-locked magnetic lock in a non-rebated door leaf, thumb turn cylinder, economy, with a silver blockade; optionally, against an additional charge, a black, magnetic lock **NEW**

**GLAZING**

- tempered 4 mm glass, frosted or transparent as a standard and, against an additional charge, laminated VSG 221 safety glass frosted or black **NEW** plain on both sides
- possibility to change the glazing side to REVERSE (OBVERSE - standard glazing)

**AVAILABLE SOLUTIONS** (pp. 135-143)

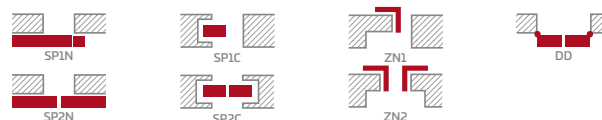

**AVAILABLE DOOR LEAF WIDTHS**



**ADDITIONAL CHARGES**

- ventilation cut
- plastic woodgrain sleeves (4 pcs)
- round and square metal sleeves (4 pcs); brushed nickel or patina finish in white or black
- ventilation grille (only for door leaf widths of 80, 90, 100)
- "100" rebated and non-rebated door leaf
- frosted or black VSG 221 laminated safety glass, **NEW** plain on both sides
- metal hinge casings in the rebated door leaf (brushed nickel, patina, polished chrome, polished brass, white and black)
- drop-down gasket <sup>2)</sup>
- can be replaced with a black magnetic lock for non-rebated door leaves
- magnetic stop (buffer) <sup>2)</sup> **NEW** (available in six colours p. 132)
- factory-drilled openings for through-mounting applies to double-section handles in our offer <sup>3)</sup>, pages 120 to 127 **NEW**

**GREKO**

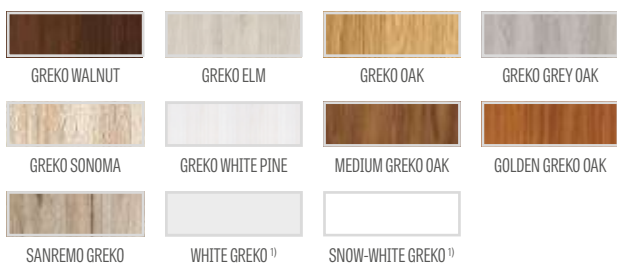

**PREMIUM**

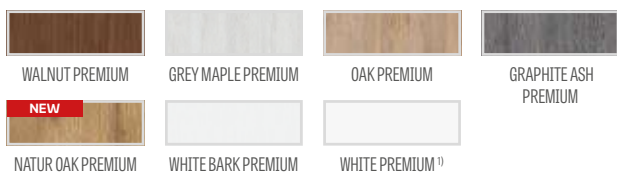

**CPL**

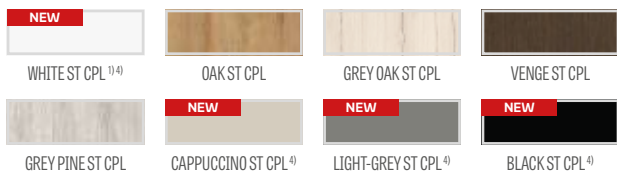

MDF stile for the GREKO and CPL laminates with the AntiFinger coating **NEW**



Glulam wood stile for the PREMIUM and CPL laminates without the AntiFinger coating

<sup>1)</sup> plain white laminate imitating a painted surface

<sup>2)</sup> the stop prevents application of a drop-down gasket and vice versa

<sup>3)</sup> applies only to the PREMIUM and ST CPL decors

<sup>4)</sup> special AntiFinger coating to reduce dirt and fingerprints



# IRYS

REBATED AND NON-REBATED INTERIOR STILE DOOR LEAVES



WHITE PREMIUM Finish, black CUBE handle



IRYS 1



IRYS 2



IRYS 3



IRYS 4



IRYS 5



IRYS 6



IRYS 7



IRYS 8



Presented model: TRYS 1 in WHITE PREMIUM laminate with a black CUBE handle



## CONSTRUCTION

- rebated or non-rebated door leaf made in the STILE technology
- MDF board vertical stiles covered with the GREKO and CPL laminate with the AntiFinger coating and vertical glulam stiles covered with thin HDF panels and the PREMIUM or CPL laminate without the Anti-Finger coating **NEW**
- 4 mm thick HDF panels with GREKO, CPL or PREMIUM laminate
- optionally, against an additional charge, upper panels extending the frame - page 134 **NEW**

## HARDWARE

- rebated door leaves: three silver 2-pin hinges adjusted horizontally
- three concealed hinges in a non-rebated leaf, silver (optionally black - subject to an additional charge); hinges supplied with and included in the price of the door frame **NEW**
- deadbolt lock in a rebated door leaf and a key-locked magnetic lock in a non-rebated door leaf, thumb turn cylinder, economy, with a silver blockade; optionally, against an additional charge, a black, magnetic lock **NEW**

## GLAZING

- 4 mm frosted or transparent tempered glass as standard, and, against an additional charge, VSG 221 laminated safety glass, frosted, plain on both sides
- possibility to change the glazing side to REVERSE (OBVERSE - standard glazing)

## AVAILABLE SOLUTIONS (pp.135-143)

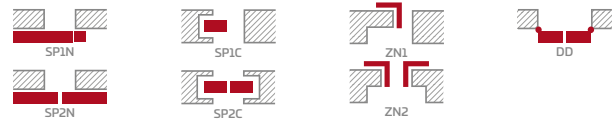

## AVAILABLE DOOR LEAF WIDTHS

60 70 80 90 100

## ADDITIONAL CHARGES

ventilation cut

plastic woodgrain sleeves (4 pcs)

round and square metal sleeves (4 pcs);  
brushed nickel or patina finish in white or black

ventilation grille (only for door leaf widths of 80, 90, 100)

"100" rebated and non-rebated door leaf

frosted VSG 221 laminated safety glass, plain on both sides

metal hinge casings in rebated door leaf  
(colour: brushed nickel, patina, glossy chrome, glossy brass, white and black)

drop-down gasket <sup>2)</sup>

can be replaced with a black magnetic lock for non-rebated door leaves

magnetic stop (buffer) <sup>2)</sup> **NEW**  
(available in six colours p. 132)

factory-drilled openings for through-mounting applies to double-section handles in our offer <sup>3)</sup>, pages 120 to 127 **NEW**

### GREKO

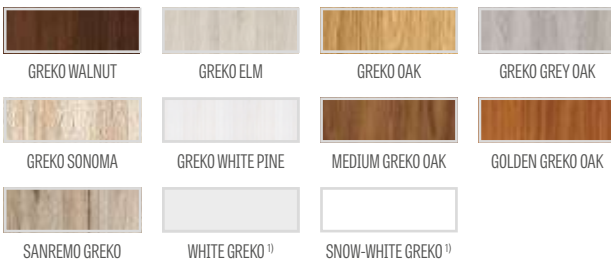

### PREMIUM

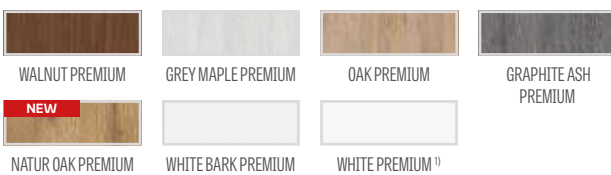

### CPL

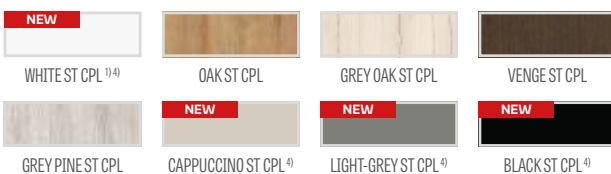

MDF stile for the GREKO and CPL laminates with the AntiFinger coating **NEW**



Glulam wood stile for the PREMIUM and CPL laminates without the AntiFinger coating

<sup>1)</sup> plain white laminate imitating a painted surface

<sup>2)</sup> the stop prevents application of a drop-down gasket and vice versa

<sup>3)</sup> applies only to the PREMIUM and ST CPL decors

<sup>4)</sup> special AntiFinger coating to reduce dirt and fingerprints



# DAGLEZJA

REBATED AND NON-REBATED INTERIOR STILE DOOR LEAVES



DAGLEZJA 1, laminate GREKO GREY OAK, CUBE SLIM handle, square, black matt



DAGLEZJA 1



DAGLEZJA 2



DAGLEZJA 3



DAGLEZJA 4



DAGLEZJA 5



DAGLEZJA 6



DAGLEZJA 7



DAGLEZJA 8

Presented model: DAGLESJA 1 in GREKO GREY OAK laminate and a black matt chrome CUBE SLIM handle



### GREKO

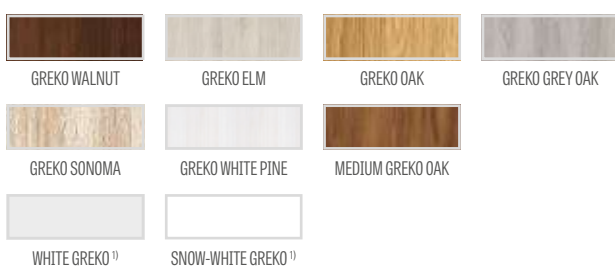

### PREMIUM

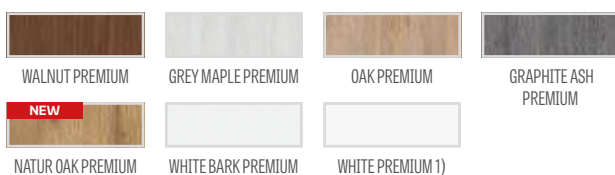

### CPL

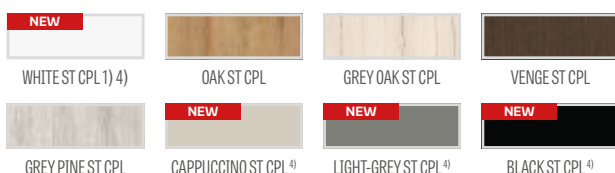

MDF stile for the GREKO and CPL laminates with the AntiFinger coating **NEW**



Glulam wood stile for the PREMIUM and CPL laminates without the AntiFinger coating

## CONSTRUCTION

- rebated or non-rebated door leaf made in the STILE technology
- MDF board vertical stiles covered with the GREKO and CPL laminate with the AntiFinger coating and vertical glulam stiles covered with thin HDF panels and the PREMIUM or CPL laminate without the AntiFinger coating **NEW**
- 4 mm thick HDF panels with GREKO, CPL or PREMIUM laminate
- very wide crossbar
- optionally, against an additional charge, upper panels extending the frame - page 134 **NEW**

## HARDWARE

- rebated door leaves: three silver 2-pin hinges adjusted horizontally
- three concealed hinges in a non-rebated leaf, silver (optionally black - subject to an additional charge); hinges supplied with and included in the price of the door frame **NEW**
- deadbolt lock in a rebated door leaf and a key-locked magnetic lock in a non-rebated door leaf, thumb turn cylinder, economy, with a silver blockade; optionally, against an additional charge, a black, magnetic lock **NEW**

## GLAZING

- tempered 4 mm glass, frosted or transparent as a standard and, against an additional charge, laminated VSG 221 safety glass frosted or black **NEW** plain on both sides
- possibility to change the glazing side to REVERSE (OBSERVE - standard glazing)

## AVAILABLE SOLUTIONS (pp. 135-143)

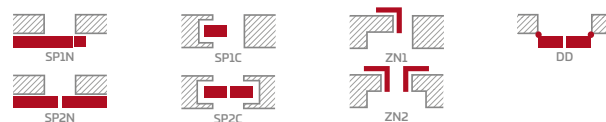

## AVAILABLE DOOR LEAF WIDTHS



## ADDITIONAL CHARGES

ventilation cut

plastic woodgrain sleeves (4 pcs)

round and square metal sleeves (4 pcs);  
brushed nickel or patina finish in white or black

ventilation grille (only for door leaf widths of 80, 90, 100) 80, 90, 100

"100" rebated and non-rebated door leaf

frosted or black VSG 221 laminated safety glass, **NEW**  
plain on both sides

metal hinge casings in rebated door leaf  
(colour: brushed nickel, patina, glossy chrome, glossy brass, white and black)

drop-down gasket <sup>2)</sup>

can be replaced with a black magnetic lock for non-rebated door leaves

magnetic stop (buffer) <sup>2)</sup> **NEW**  
(available in six colours p. 132)

factory-drilled openings for through-mounting applies to double section handles in our offer <sup>3)</sup>, pages 120 to 127 **NEW**

<sup>1)</sup> plain white laminate imitating a painted surface

<sup>2)</sup> the stop prevents application of a drop-down gasket and vice versa

<sup>3)</sup> applies only to the PREMIUM and ST CPL decors

<sup>4)</sup> special AntiFinger coating to reduce dirt and fingerprints



# FREZJA

REBATED AND NON-REBATED INTERIOR STILE DOOR LEAVES



FREZJA 5, laminate PINE ST CPL, black matt CUBE SLIM handle



FREZJA 1



FREZJA 2



FREZJA 3



FREZJA 4



FREZJA 2



FREZJA 4



FREZJA 6



FREZJA 5



FREZJA 6



FREZJA 7 3)



FREZJA 8



FREZJA 8  
ventilation cut

<sup>2)</sup> FREZJA 8 - 8 mm thick glazing  
<sup>3)</sup> FREZJA 7 - with a mirror only and a selected finish on the other side.  
Obverse - a mirror fitted on the hinge side (as shown in the photo)

Presented model: FREZJA 1 with GREY PINE ST CPL laminate and a black matt CUBE SLIM handle



## CONSTRUCTION

- rebeded or non-rebeded door leaf made in the STILE technology
- MDF board vertical stiles covered with the GREKO and CPL laminate with the AntiFinger coating and vertical glulam stiles covered with thin HDF panels and the PREMIUM or CPL laminate without the Anti-Finger coating **NEW**
- 16 mm thick HDF panels (also a 4 mm panel for the FREZJA 2 & 6 models) covered with the GREKO, CPL or PREMIUM laminate; FREZJA 7 is available with a mirror only
- optionally, against an additional charge, upper panels extending the frame - page 134 **NEW**

## HARDWARE

- rebeded door leaves: three silver 2-pin hinges adjusted horizontally
- three concealed hinges in a non-rebeded leaf, silver (optionally black - subject to an additional charge); hinges supplied with and included in the price of the door frame **NEW**
- deadbolt lock in a rebeded door leaf and a key-locked magnetic lock in a non-rebeded door leaf, thumb turn cylinder, economy, with a silver blockade; optionally, against an additional charge, a black, magnetic lock **NEW**

## GLAZING

- 4 mm frosted or transparent tempered glass or a mirror fitted on one side (only Freesia 7) as a standard and a VSG 221 frosted or black **NEW** safety glass, plain on both sides (does not apply to Freesia 7, 8)
- possibility to change the glazing side to REVERSE (OBVERSE - standard glazing)
- fixed glazing widths: FREZJA 1 – 140 mm, FREESIAO 5 – 70 mm

## AVAILABLE SOLUTIONS 3) (pp. 135-143)

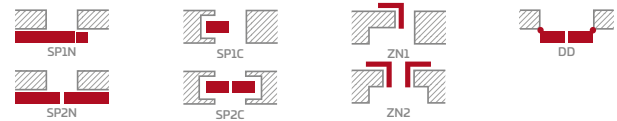

## AVAILABLE DOOR LEAF WIDTHS



## ADDITIONAL CHARGES

ventilation cut

plastic woodgrain sleeves (4 pcs)<sup>2)</sup>

round and square metal round and square metal sleeves<sup>2)</sup> (4 pcs.); brushed nickel or patina finish white and black

ventilation grille<sup>2)</sup> (only for door leaf widths of: 80, 90, 100)

"100" rebeded and non-rebeded door leaf

frosted or black VSG 221 laminated safety glass, **NEW**  
plain on both sides

metal hinge casings in the rebeded door leaf (brushed nickel, patina, polished chrome, polished brass, white and black)

drop-down gasket gasket<sup>4)</sup> (not for FREZJA 8)

can be replaced with a black magnetic lock for non-rebeded door leaves

magnetic stop (buffer)<sup>4)</sup> **NEW**  
(available in six colours p. 132)

factory-drilled openings for through-mounting applies to double-section handles in our offer<sup>5)</sup>, pages 120 to 127 **NEW**

### GREKO

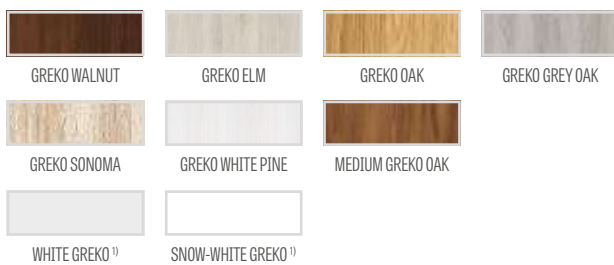

### PREMIUM

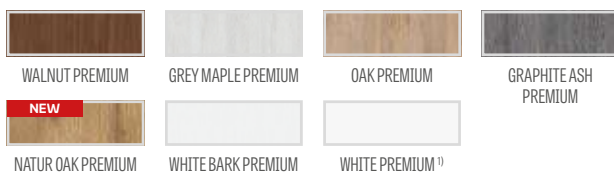

### CPL

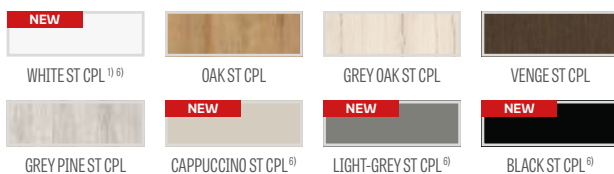

MDF stile for the GREKO and CPL laminates with the AntiFinger coating **NEW**



Glulam wood stile for the PREMIUM and CPL laminates without the AntiFinger coating

<sup>1)</sup> plain white laminate imitating a painted surface

<sup>2)</sup> not available in FREZJA 8

<sup>3)</sup> FREZJA 8 is not available for sliding systems

<sup>4)</sup> the stop prevents application of a drop-down gasket and vice versa

<sup>5)</sup> applies only to the PREMIUM and ST CPL decors

<sup>6)</sup> special AntiFinger coating to reduce dirt and fingerprints



# DEBECJA

REBATED AND NON-REBATED INTERIOR STILE DOOR LEAVES



DEBECJA 1, laminate CAPPUCCINO ST CPL, handle BELLA brass glossy



DEBECJA 1



DEBECJA 2



DEBECJA 3



DEBECJA 4



DEBECJA 5



DEBECJA 6



DEBECJA 7

Presented model: DEBECA 1 with GRAPHITE ASH PREMIUM laminate and a glossy chrome BELLA handle



## CONSTRUCTION

- rebated or non-rebated door leaf made in the STILE technology
- MDF board vertical stiles covered with the GREKO and CPL laminate with the AntiFinger coating and vertical glulam stiles covered with thin HDF panels and the PREMIUM or CPL laminate without the AntiFinger coating **NEW**
- 4 mm thick HDF panels with GREKO, CPL or PREMIUM laminate
- very wide crossbar
- optionally, against an additional charge, upper panels extending the frame - page 134 **NEW**

## HARDWARE

- rebated door leaves: three silver 2-pin hinges adjusted horizontally
- three concealed hinges in a non-rebated leaf, silver (optionally black - subject to an additional charge); hinges supplied with and included in the price of the door frame **NEW**
- deadbolt lock in a rebated door leaf and a key-locked magnetic lock in a non-rebated door leaf, thumb turn cylinder, economy, with a silver blockade; optionally, against an additional charge, a black, magnetic lock **NEW**

## GLAZING

- 4 mm frosted or transparent tempered glass as standard, and, against an additional charge, VSG 221 laminated safety glass, frosted, plain on both sides
- possibility to change the glazing side to REVERSE (OBSERVE - standard glazing)

## AVAILABLE SOLUTIONS (pp. 135-143)

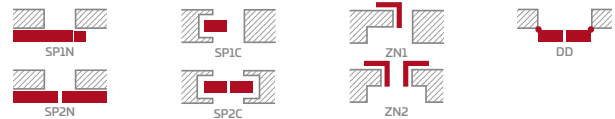

## AVAILABLE DOOR LEAF WIDTHS

60 70 80 90 100

## ADDITIONAL CHARGES

ventilation cut

plastic woodgrain sleeves (4 pcs)

round and square metal sleeves (4 pcs);  
brushed nickel or patina finish in white or black

ventilation grille (only for door leaf widths of 80, 90, 100)

"100" rebated and non-rebated door leaf

frosted VSG 221 laminated safety glass, plain on both sides

metal hinge casings in rebated door leaf  
(colour: brushed nickel, patina, glossy chrome, glossy brass, white and black)

drop-down gasket <sup>2)</sup>

can be replaced with a black magnetic lock for non-rebated door leaves

magnetic stop (buffer) <sup>2)</sup> **NEW**  
(available in six colours p. 132)

factory-drilled openings for through-mounting applies to double-section handles in our offer <sup>3)</sup>, pages 120 to 127 **NEW**

### GREKO

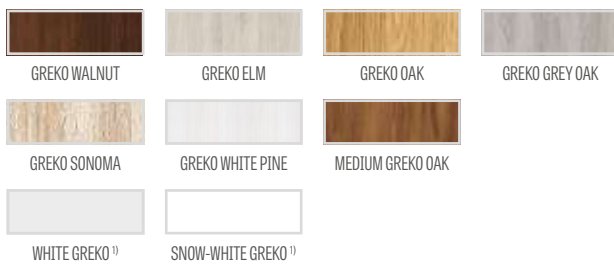

### PREMIUM

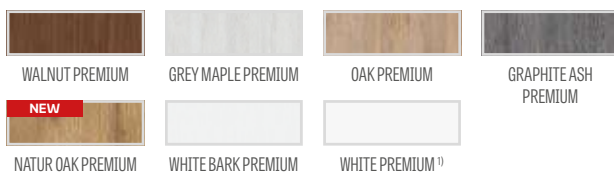

### CPL

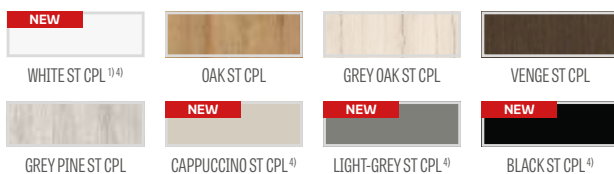

MDF stile for the GREKO and CPL laminates with the AntiFinger coating **NEW**



Glulam wood stile for the PREMIUM and CPL laminates without the AntiFinger coating

<sup>1)</sup> plain white laminate imitating a painted surface

<sup>2)</sup> the stop prevents application of a drop-down gasket and vice versa

<sup>3)</sup> applies only to the PREMIUM and ST CPL decors

<sup>4)</sup> special AntiFinger coating to reduce dirt and fingerprints



# NEMEZJA

REBATED AND NON-REBATED INTERIOR STILE DOOR LEAVES



NEMEZJA, round black matt CUBE PREMIUM handle



NEMEZJA 1



NEMEZJA 4



NEMEZJA 6



NEMEZJA 7



NEMEZJA 8



NEMEZJA 9



NEMEZJA 10



NEMEZJA 11



NEMEZJA 12



NEMEZJA 13

NEW



Presented model: NEMEZJA 6 with WHITE PREMIUM laminate and a black CUBE PREMIUM handle



## CONSTRUCTION

- rebated or non-rebated door leaf made in the STILE technology
- MDF board vertical stiles covered with the GREKO and CPL laminate with the AntiFinger coating and vertical glulam stiles covered with thin HDF panels and the PREMIUM or CPL laminate without the Anti-Finger coating **NEW**
- bevelled 16 mm thick HDF panels with a selection of GREKO, CPL or PREMIUM laminate
- optionally, against an additional charge, upper panels extending the frame - page 134 **NEW**

## HARDWARE

- rebated door leaves: three silver 2-pin hinges adjusted horizontally
- three concealed hinges in a non-rebated leaf, silver (optionally black - subject to an additional charge); hinges supplied with and included in the price of the door frame **NEW**
- deadbolt lock in a rebated door leaf and a key-locked magnetic lock in a non-rebated door leaf, thumb turn cylinder, economy, with a silver blockade; optionally, against an additional charge, a black, magnetic lock **NEW**

## GLAZING

- 4 mm frosted or transparent tempered glass as standard, and, against an additional charge, VSG 221 laminated safety glass, frosted, plain on both sides
- possibility to change the glazing side to REVERSE (OBSERVE - standard glazing)

## AVAILABLE SOLUTIONS (pp.135-143)

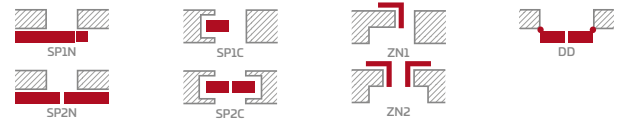

## AVAILABLE DOOR LEAF WIDTHS

60 70 80 90 100

## ADDITIONAL CHARGES

ventilation cut

plastic woodgrain sleeves (4 pcs)

round and square metal sleeves (4 pcs);  
brushed nickel or patina finish in white or black

ventilation grille (only for door leaf widths of 80, 90, 100)

"100" rebated and non-rebated door leaf

frosted VSG 221 laminated safety glass, plain on both sides

metal hinge casings in the rebated door leaf (brushed nickel, patina, polished chrome, polished brass, white and black)

drop-down gasket <sup>2)</sup>

can be replaced with a black magnetic lock for non-rebated door leaves

magnetic stop (buffer) <sup>2)</sup> **NEW**  
(available in six colours p. 132)

factory-drilled openings for through-mounting applies to double-section handles in our offer, pages 120 to 127 **NEW**

### GREKO

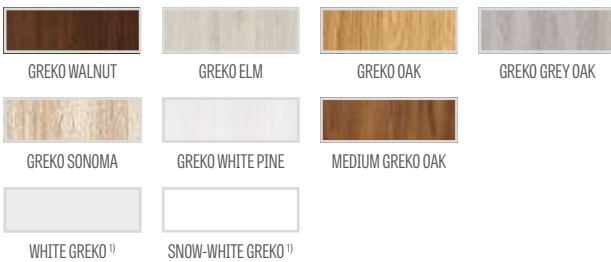

### PREMIUM

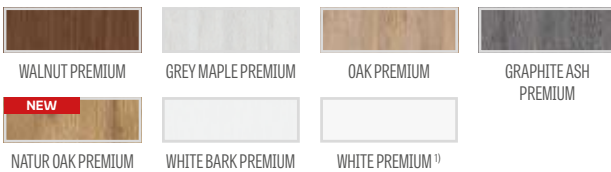

### CPL

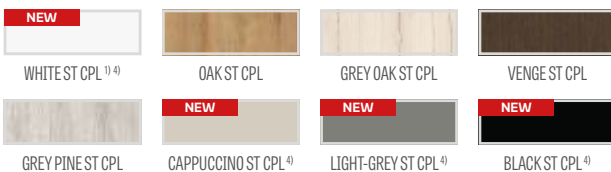

MDF stile for the GREKO and CPL laminates with the AntiFinger coating **NEW**



Glulam wood stile for the PREMIUM and CPL laminates without the AntiFinger coating

<sup>1)</sup> plain white laminate imitating a painted surface

<sup>2)</sup> the stop prevents application of a drop-down gasket and vice versa

<sup>3)</sup> applies only to the PREMIUM and ST CPL decors

<sup>4)</sup> special AntiFinger coating to reduce dirt and fingerprints



# BERBERYS

REBATED AND NON-REBATED INTERIOR STILE DOOR LEAVES



GRAPHITE ASH PREMIUM laminate, TOPAZ INOX handle



BERBERYS 1



BERBERYS 2



BERBERYS 3



BERBERYS 4



BERBERYS 5



BERBERYS 6



BERBERYS 7



BERBERYS 8

Presented model: BERBERYS1 with GRAPHITE ASH PREMIUM laminate and a TOPAZ INOX handle



## CONSTRUCTION

- rebated or non-rebated door leaf made in the STILE technology
- MDF board vertical stiles covered with the GREKO and CPL laminate with the AntiFinger coating and vertical glulam stiles covered with thin HDF panels and the PREMIUM or CPL laminate without the Anti-Finger coating **NEW**
- 4 mm thick HDF panels with GREKO, CPL or PREMIUM laminate
- brushed aluminium insert profiles
- optionally, against an additional charge, upper panels extending the frame - page 134 **NEW**

## HARDWARE

- rebated door leaves: three silver 2-pin hinges adjusted horizontally
- three concealed hinges in a non-rebated leaf, silver (optionally black - subject to an additional charge); hinges supplied with and included in the price of the door frame **NEW**
- deadbolt lock in a rebated door leaf and a key-locked magnetic lock in a non-rebated door leaf, thumb turn cylinder, economy, with a silver blockade; optionally, against an additional charge, a black, magnetic lock **NEW**

## GLAZING

- 4 mm frosted or transparent tempered glass as standard, and, against an additional charge, VSG 221 laminated safety glass, frosted, plain on both sides
- possibility to change the glazing side to REVERSE (OBSERVE - standard glazing)

## AVAILABLE SOLUTIONS (pp. 135-143)

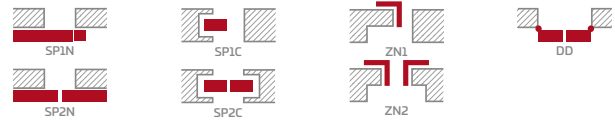

## AVAILABLE DOOR LEAF WIDTHS

60 70 80 90 100

## ADDITIONAL CHARGES

ventilation cut

plastic woodgrain sleeves (4 pcs)

round and square metal sleeves (4 pcs);  
brushed nickel or patina finish in white or black

ventilation grille (only for door leaf widths of 80, 90, 100)

"100" rebated and non-rebated door leaf

frosted VSG 221 laminated safety glass, plain on both sides

metal hinge casings in rebated door leaf  
(colour: brushed nickel, patina, glossy chrome, glossy brass, white and black)

drop-down gasket <sup>2)</sup>

can be replaced with a black magnetic lock for non-rebated door leaves

magnetic stop (buffer) <sup>2)</sup> **NEW**  
(available in six colours p. 132)

factory-drilled openings for through-mounting applies to double-section handles in our offer <sup>3)</sup>, pages 120 to 127 **NEW**

### GREKO

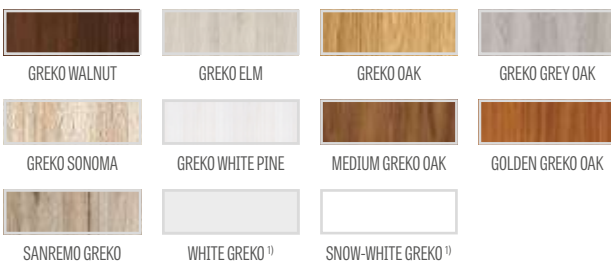

### PREMIUM

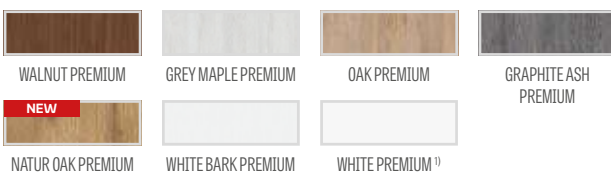

### CPL

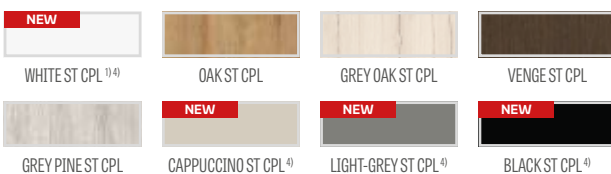

MDF stile for the GREKO and CPL laminates with the AntiFinger coating **NEW**



Glulam wood stile for the PREMIUM and CPL laminates without the AntiFinger coating

<sup>1)</sup> plain white laminate imitating a painted surface

<sup>2)</sup> the stop prevents application of a drop-down gasket and vice versa

<sup>3)</sup> applies only to the PREMIUM and ST CPL decors

<sup>4)</sup> special AntiFinger coating to reduce dirt and fingerprints



# FLOKS

REBATED AND NON-REBATED INTERIOR STILE DOOR LEAVES



FLOKS 8, laminate OAK ST CPL, brushed chrome CUBE handle, matt



FLOKS 1



FLOKS 2



FLOKS 3



FLOKS 4



FLOKS 5



FLOKS 6



FLOKS 7



FLOKS 8

Presented model: FLOKS 1 in OAK ST CPL finish with matt brushed chrome CUBE handle



## CONSTRUCTION

- rebated or non-rebated door leaf made in the STILE technology
- MDF board vertical stiles covered with the GREKO and CPL laminate with the AntiFinger coating and vertical glulam stiles covered with thin HDF panels and the PREMIUM or CPL laminate without the AntiFinger coating **NEW**
- 4 mm thick HDF panels with GREKO, CPL or PREMIUM laminate
- brushed aluminium insert profiles
- optionally, against an additional charge, upper panels extending the frame - page 134 **NEW**

## HARDWARE

- rebated door leaves: three silver 2-pin hinges adjusted horizontally
- three concealed hinges in a non-rebated leaf, silver (optionally black - subject to an additional charge); hinges supplied with and included in the price of the door frame **NEW**
- deadbolt lock in a rebated door leaf and a key-locked magnetic lock in a non-rebated door leaf, thumb turn cylinder, economy, with a silver blockade; optionally, against an additional charge, a black, magnetic lock **NEW**

## GLAZING

- tempered 4 mm glass, frosted or transparent as a standard and, against an additional charge, laminated VSG 221 safety glass frosted or black **NEW** plain on both sides
- possibility to change the glazing side to REVERSE (OBSERVE - standard glazing)

## AVAILABLE SOLUTIONS (pp. 135-143)

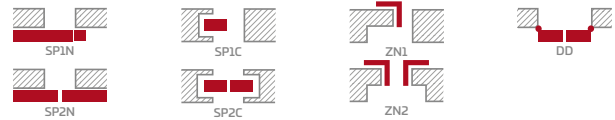

## AVAILABLE DOOR LEAF WIDTHS

60 70 80 90 100

## ADDITIONAL CHARGES

ventilation cut

plastic woodgrain sleeves (4 pcs)

round and square metal sleeves (4 pcs);  
brushed nickel or patina finish in white or black

ventilation grille (only for door leaf widths of 80, 90, 100)

"100" rebated and non-rebated door leaf

frosted or black VSG 221 laminated safety glass, **NEW**

plain on both sides

metal hinge casings in rebated door leaf  
(colour: brushed nickel, patina, glossy chrome, glossy brass, white and black)

drop-down gasket <sup>2)</sup>

can be replaced with a black magnetic lock for non-rebated door leaves

magnetic stop (buffer) <sup>2)</sup> **NEW**  
(available in six colours p. 132)

factory-drilled openings for through-mounting applies to double-section handles in our offer <sup>3)</sup>, pages 120 to 127 **NEW**

### GREKO

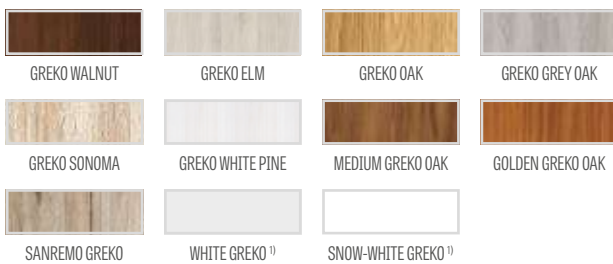

### PREMIUM

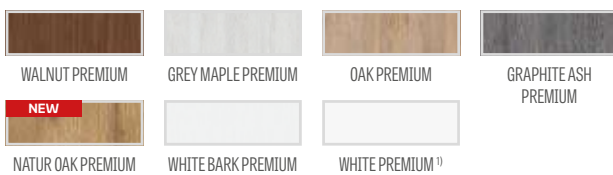

### CPL

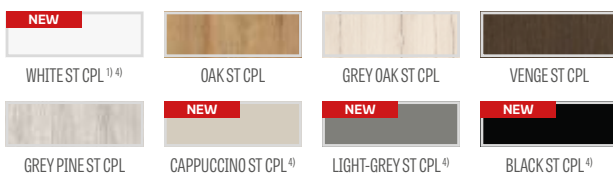

MDF stile for the GREKO and CPL laminates with the AntiFinger coating **NEW**



Glulam wood stile for the PREMIUM and CPL laminates without the AntiFinger coating

<sup>1)</sup> plain white laminate imitating a painted surface

<sup>2)</sup> the stop prevents application of a drop-down gasket and vice versa

<sup>3)</sup> applies only to the PREMIUM and ST CPL decors

<sup>4)</sup> special AntiFinger coating to reduce dirt and fingerprints



# KROKUS

REBATED AND NON-REBATED INTERIOR STILE DOOR LEAVES

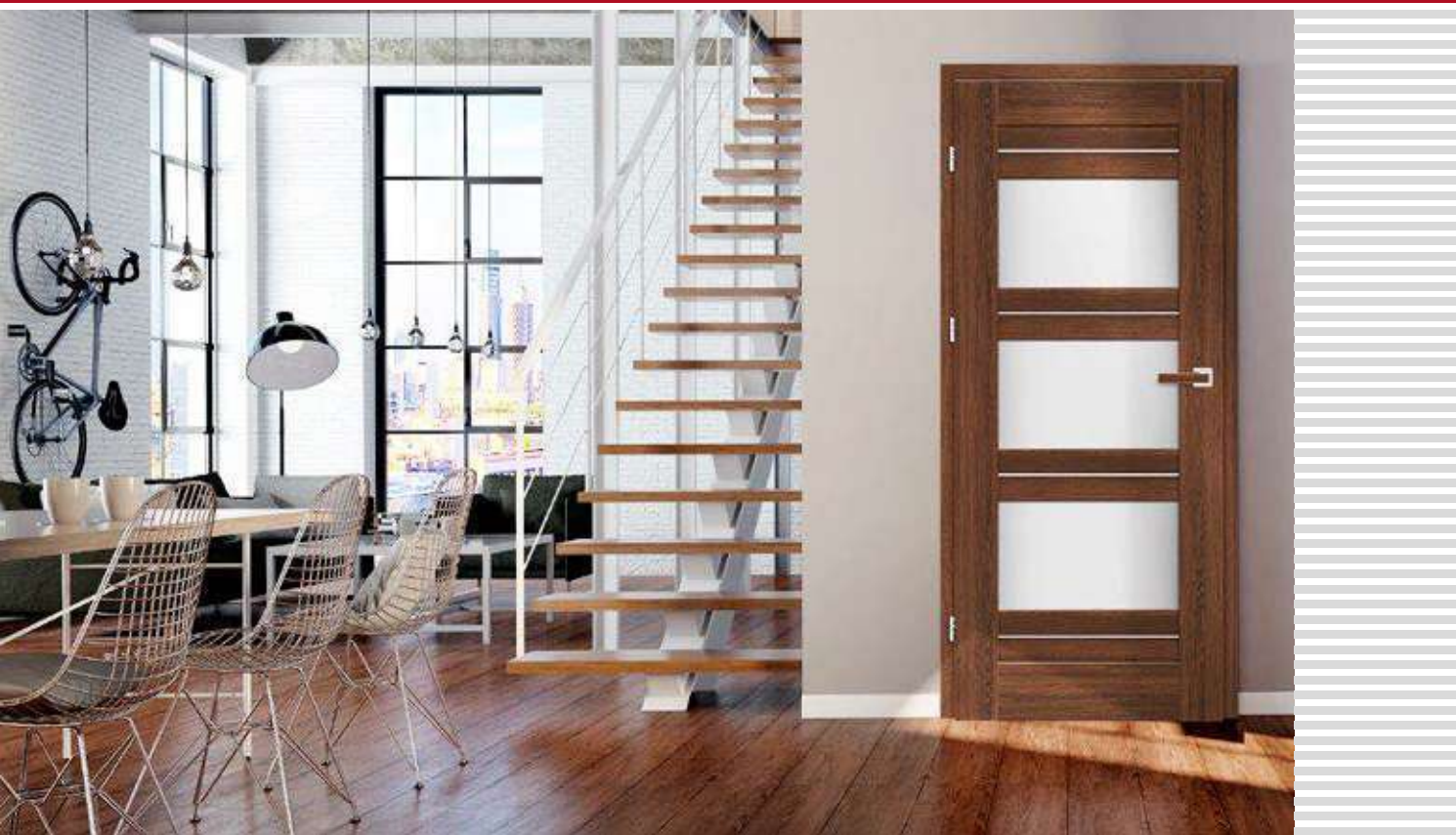

KROKUS 1, laminate GREKO WALNT, DECO handle



KROKUS 1



KROKUS 2



KROKUS 3



KROKUS 4



KROKUS 5



KROKUS 6

Presented model: KROKUS<sup>1</sup> with GREKO WALNUT laminate and a DECO handle



## CONSTRUCTION

- rebated or non-rebated door leaf made in the STILE technology
- MDF board vertical stiles covered with the GREKO and CPL laminate with the AntiFinger coating and vertical glulam stiles covered with thin HDF panels and the PREMIUM or CPL laminate without the Anti-Finger coating **NEW**
- 4 mm thick HDF panels with GREKO, CPL or PREMIUM laminate
- brushed aluminium insert profiles
- optionally, against an additional charge, upper panels extending the frame - page 134 **NEW**

## HARDWARE

- rebated door leaves: three silver 2-pin hinges adjusted horizontally
- three concealed hinges in a non-rebated leaf, silver (optionally black - subject to an additional charge); hinges supplied with and included in the price of the door frame **NEW**
- deadbolt lock in a rebated door leaf and a key-locked magnetic lock in a non-rebated door leaf, thumb turn cylinder, economy, with a silver blockade; optionally, against an additional charge, a black, magnetic lock **NEW**

## GLAZING

- 4 mm frosted or transparent tempered glass as standard, and, against an additional charge, VSG 221 laminated safety glass, frosted, plain on both sides
- possibility to change the glazing side to REVERSE (OBSERVE - standard glazing)

## AVAILABLE SOLUTIONS (pp. 135-143)

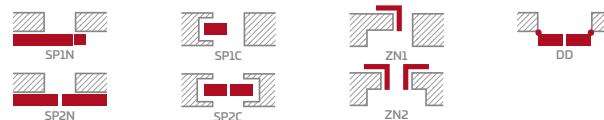

## AVAILABLE DOOR LEAF WIDTHS

60 70 80 90 100

## ADDITIONAL CHARGES

- ventilation cut
- plastic woodgrain sleeves (4 pcs)
- round and square metal sleeves (4 pcs); brushed nickel or patina finish in white or black
- ventilation grille (only for door leaf widths of 80, 90, 100)
- "100" rebated and non-rebated door leaf
- frosted VSG 221 laminated safety glass, plain on both sides
- metal hinge casings in rebated door leaf (colour: brushed nickel, patina, glossy chrome, glossy brass, white and black)
- drop-down gasket <sup>2)</sup>
- can be replaced with a black magnetic lock for non-rebated door leaves
- magnetic stop (buffer) <sup>2)</sup> **NEW** (available in six colours p. 132)
- factory-drilled openings for through-mounting applies to double-section handles in our offer <sup>3)</sup>, pages 120 to 127 **NEW**

### GREKO

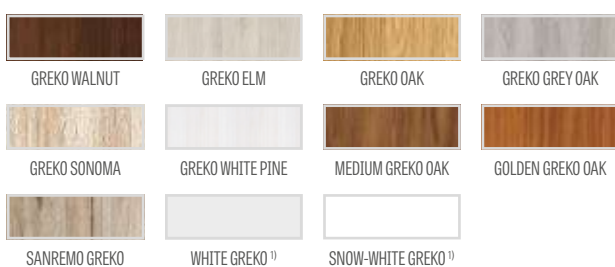

### PREMIUM

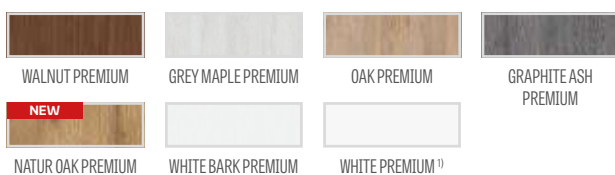

### CPL

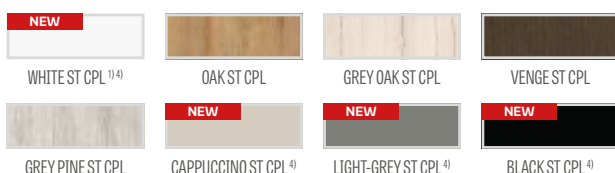

MDF stile for the GREKO and CPL laminates with the AntiFinger coating **NEW**



Glulam wood stile for the PREMIUM and CPL laminates without the AntiFinger coating

<sup>1)</sup> plain white laminate imitating a painted surface

<sup>2)</sup> the stop prevents application of a drop-down gasket and vice versa

<sup>3)</sup> applies only to the PREMIUM and ST CPL decors

<sup>4)</sup> special AntiFinger coating to reduce dirt and fingerprints



# KAMELIA

REBATED AND NON-REBATED INTERIOR STILE DOOR LEAVES



KAMELIA 1, laminate GRAPHITE PREMIUM ASH, brushed chrome CUBE handle, matt



KAMELIA 1



KAMELIA 2



KAMELIA 3



KAMELIA 4



KAMELIA 5



KAMELIA 6



KAMELIA 7



KAMELIA 8



Presented model: KAMELIA 1 with GRAPHITE ASH PREMIUM laminate and a brushed chrome CUBE handle, matt



## CONSTRUCTION

- rebated or non-rebated door leaf made in the STILE technology
- MDF board vertical stiles covered with the GREKO and CPL laminate with the AntiFinger coating and vertical glulam stiles covered with thin HDF panels and the PREMIUM or CPL laminate without the Anti-Finger coating **NEW**
- 4 mm thick HDF panels with GREKO, CPL or PREMIUM laminate
- optionally, against an additional charge, upper panels extending the frame - page 134 **NEW**

## HARDWARE

- rebated door leaves: three silver 2-pin hinges adjusted horizontally
- three concealed hinges in a non-rebated leaf, silver (optionally black - subject to an additional charge); hinges supplied with and included in the price of the door frame **NEW**
- deadbolt lock in a rebated door leaf and a key-locked magnetic lock in a non-rebated door leaf, thumb turn cylinder, economy, with a silver blockade; optionally, against an additional charge, a black, magnetic lock **NEW**

## GLAZING

- 4 mm frosted or transparent tempered glass as standard, and, against an additional charge, VSG 221 laminated safety glass, frosted, plain on both sides
- possibility to change the glazing side to REVERSE (OBVERSE - standard glazing)

## AVAILABLE SOLUTIONS (pp.135-143)

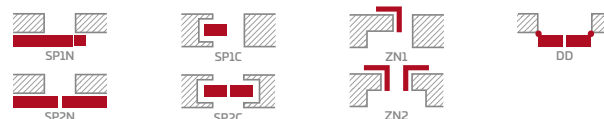

## AVAILABLE DOOR LEAF WIDTHS

60 70 80 90 100

## ADDITIONAL CHARGES

ventilation cut

plastic woodgrain sleeves (4 pcs)

round and square metal sleeves (4 pcs);  
brushed nickel or patina finish in white or black

ventilation grille (only for door leaf widths of 80, 90, 100)

"100" rebated and non-rebated door leaf

frosted VSG 221 laminated safety glass, plain on both sides

metal hinge casings in rebated door leaf  
(colour: brushed nickel, patina, glossy chrome, glossy brass, white and black)

drop-down gasket <sup>2)</sup>

can be replaced with a black magnetic lock for non-rebated door leaves

magnetic stop (buffer) <sup>2)</sup> **NEW**  
(available in six colours p. 132)

factory-drilled openings for through-mounting applies to double-section handles in our offer <sup>3)</sup>, pages 120 to 127 **NEW**

### GREKO

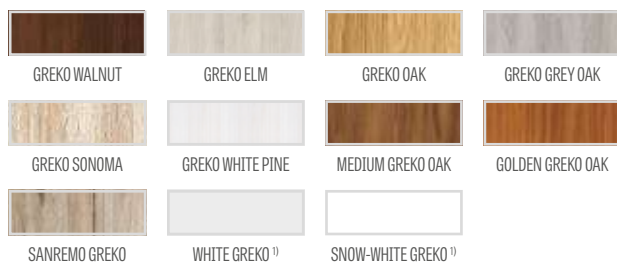

### PREMIUM

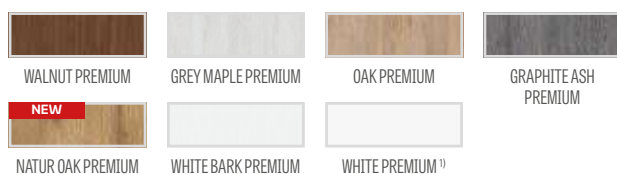

### CPL

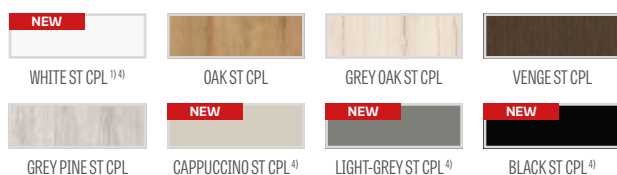

MDF stile for the GREKO and CPL laminates with the AntiFinger coating **NEW**



Glulam wood stile for the PREMIUM and CPL laminates without the AntiFinger coating

<sup>1)</sup> plain white laminate imitating a painted surface

<sup>2)</sup> the stop prevents application of a drop-down gasket and vice versa

<sup>3)</sup> applies only to the PREMIUM and ST CPL decors

<sup>4)</sup> special AntiFinger coating to reduce dirt and fingerprints



# PETUNIA

REBATED AND NON-REBATED INTERIOR STILE DOOR LEAVES



PETUNIA 1, laminate OAK PREMIUM, TOPAZ INOX handle



PETUNIA 1



PETUNIA 2



PETUNIA 3



PETUNIA 4



PETUNIA 5



PETUNIA 6



PETUNIA 7



PETUNIA 8

Presented model: PETUNIA 1 with OAK PREMIUM laminate and a TOPAZ INOX handle



## CONSTRUCTION

- rebated or non-rebated door leaf made in the STILE technology
- MDF board vertical stiles covered with the GREKO and CPL laminate with the AntiFinger coating and vertical glulam stiles covered with thin HDF panels and the PREMIUM or CPL laminate without the Anti-Finger coating **NEW**
- 4 mm thick HDF panels with GREKO, CPL or PREMIUM laminate
- optionally, against an additional charge, upper panels extending the frame - page 134 **NEW**

## HARDWARE

- rebated door leaves: three silver 2-pin hinges adjusted horizontally
- three concealed hinges in a non-rebated leaf, silver (optionally black - subject to an additional charge); hinges supplied with and included in the price of the door frame **NEW**
- deadbolt lock in a rebated door leaf and a key-locked magnetic lock in a non-rebated door leaf, thumb turn cylinder, economy, with a silver blockade; optionally, against an additional charge, a black, magnetic lock **NEW**

## GLAZING

- 4 mm frosted or transparent tempered glass as standard, and, against an additional charge, VSG 221 laminated safety glass, frosted, plain on both sides
- possibility to change the glazing side to REVERSE (OBVERSE - standard glazing)

## AVAILABLE SOLUTIONS (pp.135-143)

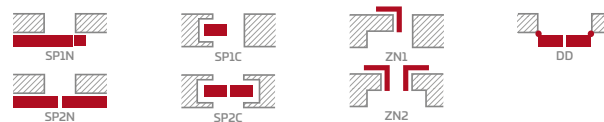

## AVAILABLE DOOR LEAF WIDTHS

60 70 80 90 100

## ADDITIONAL CHARGES

ventilation cut

plastic woodgrain sleeves (4 pcs)

round and square metal sleeves (4 pcs);  
brushed nickel or patina finish in white or black

ventilation grille (only for door leaf widths of 80, 90, 100)

"100" rebated and non-rebated door leaf

frosted VSG 221 laminated safety glass, plain on both sides

metal hinge casings in rebated door leaf  
(colour: brushed nickel, patina, glossy chrome, glossy brass, white and black)

drop-down gasket <sup>2)</sup>

can be replaced with a black magnetic lock for non-rebated door leaves

magnetic stop (buffer) <sup>2)</sup> **NEW**  
(available in six colours p. 132)

factory-drilled openings for through-mounting applies to double-section handles in our offer <sup>3)</sup>, pages 120 to 127 **NEW**

### GREKO

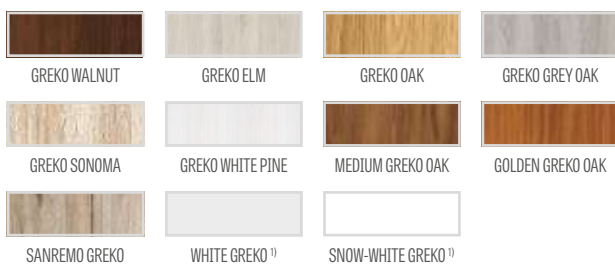

### PREMIUM

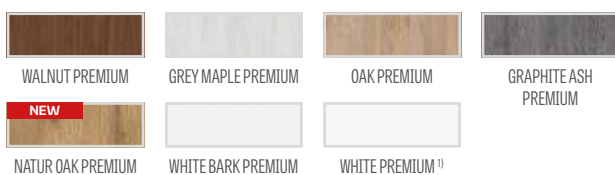

### CPL

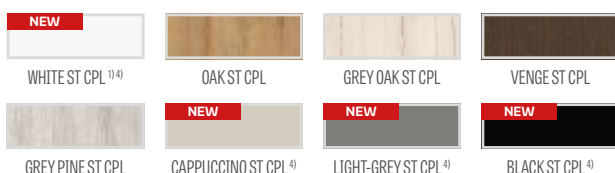

MDF stile for the GREKO and CPL laminates with the AntiFinger coating **NEW**



Glulam wood stile for the PREMIUM and CPL laminates without the AntiFinger coating

<sup>1)</sup> plain white laminate imitating a painted surface

<sup>2)</sup> the stop prevents application of a drop-down gasket and vice versa

<sup>3)</sup> applies only to the PREMIUM and ST CPL decors

<sup>4)</sup> special AntiFinger coating to reduce dirt and fingerprints



# AZALIA

REBATED AND NON-REBATED INTERIOR STILE DOOR LEAVES



AZALIA 1, laminate OAK ST CPL, CUBE handle - bushed chrome, matt



AZALIA 1



AZALIA 2



AZALIA 3



AZALIA 4



AZALIA 5



AZALIA 6



AZALIA 7



AZALIA 8

Presented model: AZALIA 1 with OAK ST CPL laminate and a brushed chrome CUBE handle, matt



## CONSTRUCTION

- rebated or non-rebated door leaf made in the STILE technology
- MDF board vertical stiles covered with the GREKO and CPL laminate with the AntiFinger coating and vertical glulam stiles covered with thin HDF panels and the PREMIUM or CPL laminate without the Anti-Finger coating **NEW**
- 4 mm thick HDF panels with GREKO, CPL or PREMIUM laminate
- optionally, against an additional charge, upper panels extending the frame - page 134 **NEW**

## HARDWARE

- rebated door leaves: three silver 2-pin hinges adjusted horizontally
- three concealed hinges in a non-rebated leaf, silver (optionally black - subject to an additional charge); hinges supplied with and included in the price of the door frame **NEW**
- deadbolt lock in a rebated door leaf and a key-locked magnetic lock in a non-rebated door leaf, thumb turn cylinder, economy, with a silver blockade; optionally, against an additional charge, a black, magnetic lock **NEW**

## GLAZING

- 4 mm frosted or transparent tempered glass as standard, and, against an additional charge, VSG 221 laminated safety glass, frosted, plain on both sides
- possibility to change the glazing side to REVERSE (OBSERVE - standard glazing)

## AVAILABLE SOLUTIONS (pp. 135-143)

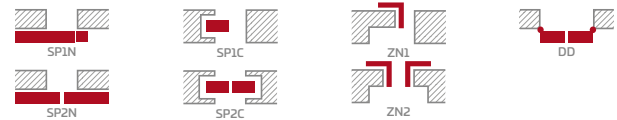

## AVAILABLE DOOR LEAF WIDTHS

60 70 80 90 100

## ADDITIONAL CHARGES

ventilation cut

plastic woodgrain sleeves (4 pcs)

round and square metal sleeves (4 pcs);  
brushed nickel or patina finish in white or black

ventilation grille (only for door leaf widths of 80, 90, 100)

"100" rebated and non-rebated door leaf

frosted VSG 221 laminated safety glass, plain on both sides

metal hinge casings in rebated door leaf  
(colour: brushed nickel, patina, glossy chrome, glossy brass, white and black)

drop-down gasket <sup>2)</sup>

can be replaced with a black magnetic lock for non-rebated door leaves

magnetic stop (buffer) <sup>2)</sup> **NEW**  
(available in six colours p. 132)

factory-drilled openings for through-mounting applies to double-section handles in our offer <sup>3)</sup>, pages 120 to 127 **NEW**

### GREKO

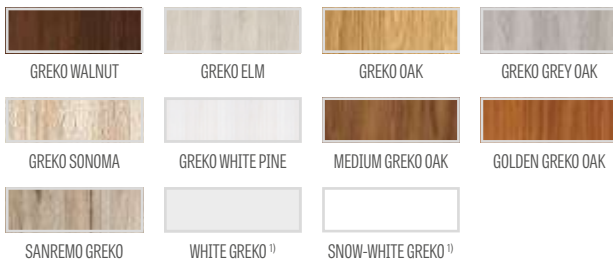

### PREMIUM

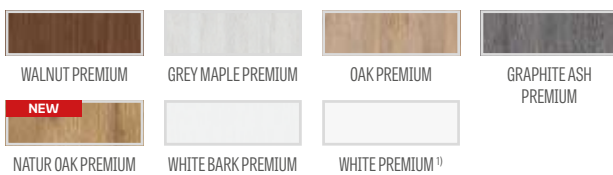

### CPL

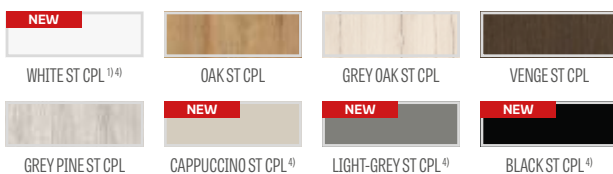

MDF stile for the GREKO and CPL laminates with the AntiFinger coating **NEW**



Glulam wood stile for the PREMIUM and CPL laminates without the AntiFinger coating

<sup>1)</sup> plain white laminate imitating a painted surface

<sup>2)</sup> the stop prevents application of a drop-down gasket and vice versa

<sup>3)</sup> applies only to the PREMIUM and ST CPL decors

<sup>4)</sup> special AntiFinger coating to reduce dirt and fingerprints



# HIACYNT

REBATED AND NON-REBATED INTERIOR STILE DOOR LEAVES



HIACYNT 6, laminate MEDIUM GREKO OAK, TOPAZ INOX handle



HIACYNT 1



HIACYNT 2



HIACYNT 3



HIACYNT 4



HIACYNT 5



HIACYNT 6



HIACYNT 7



HIACYNT 8

Presented model: HIACYNT 1 with MEDIUM GREKO OAK laminate and a TOPAZ INOX handle



## CONSTRUCTION

- rebated or non-rebated door leaf made in the STILE technology
- MDF board vertical stiles covered with the GREKO and CPL laminate with the AntiFinger coating and vertical glulam stiles covered with thin HDF panels and the PREMIUM or CPL laminate without the Anti-Finger coating **NEW**
- 22mm thick HDF panels with GREKO, CPL or PREMIUM laminate
- optionally, against an additional charge, upper panels extending the frame - page 134 **NEW**

## HARDWARE

- rebated door leaves: three silver 2-pin hinges adjusted horizontally
- three concealed hinges in a non-rebated leaf, silver (optionally black - subject to an additional charge); hinges supplied with and included in the price of the door frame **NEW**
- deadbolt lock in a rebated door leaf and a key-locked magnetic lock in a non-rebated door leaf, thumb turn cylinder, economy, with a silver blockade; optionally, against an additional charge, a black, magnetic lock **NEW**

## GLAZING

- 4 mm frosted or transparent tempered glass as standard, and, against an additional charge, VSG 221 laminated safety glass, frosted, plain on both sides
- possibility to change the glazing side to REVERSE (OBVERSE - standard glazing)

## AVAILABLE SOLUTIONS (pp.135-143)

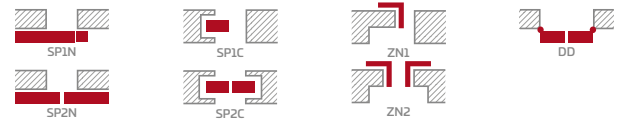

## AVAILABLE DOOR LEAF WIDTHS

60 70 80 90 100

## ADDITIONAL CHARGES

ventilation cut

plastic woodgrain sleeves (4 pcs)

round and square metal sleeves (4 pcs);  
brushed nickel or patina finish in white or black

ventilation grille (only for door leaf widths of 80, 90, 100)

"100" rebated and non-rebated door leaf

frosted VSG 221 laminated safety glass, plain on both sides

metal hinge casings in the rebated door leaf (brushed nickel, patina, polished chrome, polished brass, white and black)

drop-down gasket <sup>2)</sup>

can be replaced with a black magnetic lock for non-rebated door leaves

magnetic stop (buffer) <sup>2)</sup> **NEW**  
(available in six colours p. 132)

factory-drilled openings for through-mounting applies to double section handles in our offer <sup>3)</sup>, pages 120 to 127 **NEW**

### GREKO

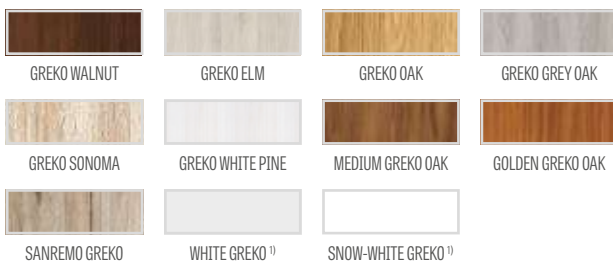

### PREMIUM

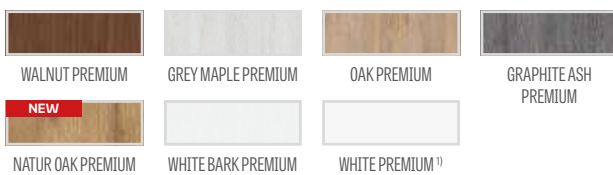

### CPL

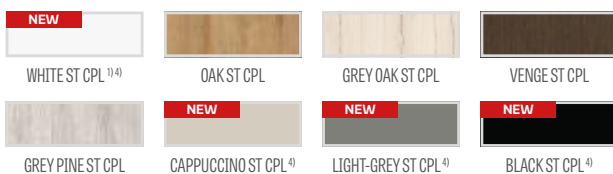

MDF stile for the GREKO and CPL laminates with the AntiFinger coating **NEW**



Glulam wood stile for the PREMIUM and CPL laminates without the AntiFinger coating

<sup>1)</sup> plain white laminate imitating a painted surface

<sup>2)</sup> the stop prevents application of a drop-down gasket and vice versa

<sup>3)</sup> applies only to the PREMIUM and ST CPL decors

<sup>4)</sup> special AntiFinger coating to reduce dirt and fingerprints



# FRAGI

REBATED INTERIOR STILE DOORS



WHITE ST CPL Finish, black matt CUBE handle, black VSG glass



FRAGI 1



FRAGI 4  
DECORMAT



FRAGI 5  
TRANSPARENT



FRAGI 7  
DECORMAT GRAFIT



FRAGI 9



FRAGI 10



FRAGI 15  
Frosted VSG/ESG



FRAGI 16  
Black VSG/ESG



Presented model: FRAGI 4 with GREKO WALNUT laminate and a DECO handle



## CONSTRUCTION

- rebated door leaf made in STILE technology
- MDF board vertical stiles covered with the GREKO and CPL laminate with the AntiFinger coating and vertical glulam stiles covered with thin HDF panels and the PREMIUM or CPL laminate without the AntiFinger coating **NEW**
- optionally, against an additional charge, upper panels extending the frame - page 134 **NEW**

## HARDWARE

- rebated door leaves: three silver 2-pin hinges adjusted horizontally
- a deadbolt lock, euro profile cylinder, economy lock or with a thumb turn

## GLAZING

- 8 mm tempered or tempered and VSG/ESG 441 laminated safety glass, frosted or black **NEW**, plain on both sides (for Fragi 15 & Fragi 16 models)
- possibility to change the glazing side to REVERSE (OBSERVE - standard glazing)

## AVAILABLE SOLUTIONS (pp. 144-146)



## AVAILABLE DOOR LEAF WIDTHS

60 70 80 90

## ADDITIONAL CHARGES

ventilation cut

metal hinge casings in rebated door leaf  
(colour: brushed nickel, patina, glossy chrome, glossy brass, white and black)

factory-drilled openings for through-mounting applies to double-section handles in our offer <sup>2)</sup> pages 120 to 127

magnetic stop (buffer) **NEW**  
(available in six colours p. 132)

Note:

The picture shows only an 80cm-wide door leaf. The proportion in the picture differ slightly for the other FRAGI 1 model widths. For further details and photos go to our website: [www.erkado.pl](http://www.erkado.pl)

### GREKO

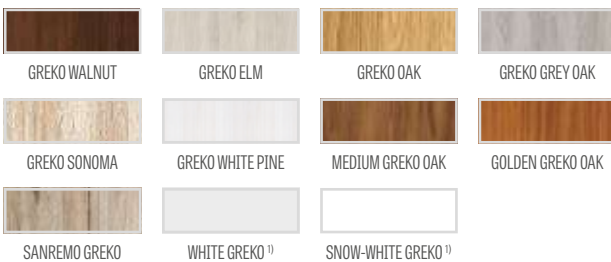

### PREMIUM

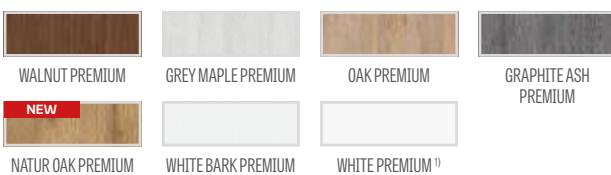

### CPL

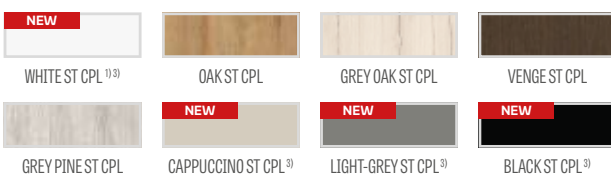

MDF stile for the GREKO and CPL laminates with the AntiFinger coating **NEW**



Glulam wood stile for the PREMIUM and CPL laminates without the AntiFinger coating

## STANDARD "OBSERVE" GLAZING

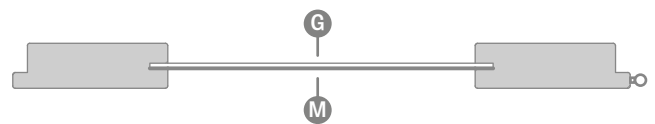

## "REVERSE" GLAZING MADE TO ORDER

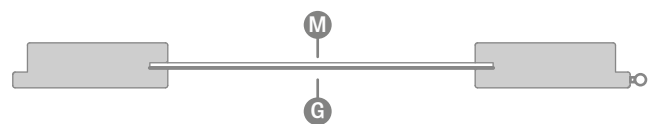

**G** Plain side; **M** ornamented matt side;

<sup>1)</sup> plain white laminate imitating a painted surface

<sup>2)</sup> applies only to the PREMIUM and ST CPL decors

<sup>3)</sup> special AntiFinger coating to reduce dirt and fingerprints



# GRAF GLASS DOORS

INTERIOR GLASS DOORS



GRAF 1



GRAF 6



GRAF 8 DECORMAT



GRAF 9 TRANSPARENT



GRAF 11 DECORMAT GRAPHITE



GRAF 17



GRAF 22



GRAF 26 DARK GREY



GRAF 32



GRAF 35



GRAF 36



GRAF 38

GLAZING TRANSLUCENCY ILLUSTRATION on p. 133

NEW



Presented model: GRAF 36 with WHITE CPL laminate

### CONSTRUCTION

- 8 mm tempered glass, 8 mm tinted glass (GRAF 26)
- possibility to change the glazing side to REVERSE (OBSERVE - standard glazing)
- frosted glass with black or white painted decorative patterns
- the line width (thickness) of the GRAF 1, 6, 17, 35, 36, 38 models is 30 mm
- optionally, against an additional charge, upper panels extending the frame - page 134 **NEW**

### FIXED AND ADJUSTABLE FRAMES

- for prices of fixed and adjustable frames for rebated doors go to pp. 161-163
- no electric strike possible
- 10 mm pin hinge for glass panes frames
- **ONLY REBATED FRAMES IN ALL AVAILABLE DECORS, STEEL FRAMES AND THE WHITE PAINTED TITANIUM UV FRAME ARE AVAILABLE FOR GLASS GRAF DOORS**

NOTE: For the extended Glass Door Collection and a variety of available models go to our website: [www.erkado.pl](http://www.erkado.pl). You can also order the available models through the B2B panel.

See more at [www.erkado.pl](http://www.erkado.pl)



### AVAILABLE DOOR LEAF WIDTHS

60 70 80 90 (charged extra)

### ADDITIONAL CHARGES

"90" door leaf

ventilation cut

### METAL-BUD HARDWARE stainless steel

**Metal-Bud**

PRODUCENT KLAMEK

Available shapes: oval or rectangle



2A OVAL



3A OVAL



1A OVAL



4AZ OVAL EXTERNAL <sup>1)</sup>  
4AW OVAL INTERNAL



Oval HINGE



2B RECTANGLE

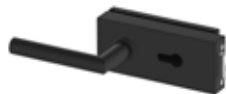

3B RECTANGLE



1B RECTANGLE



4BZ RECTANGLE EXTERNAL <sup>1)</sup>  
4BW RECTANGLE INTERNAL



Rectangle HINGE

<sup>1)</sup> detailed description of bathroom fittings selection (lock with a blockade) page 131



# DECORATIVE PANELS

WALL-MOUNTED



Decorative panel: decorative strip OAK STC PL, adapter BLACK ST CPL, skirting board OAK ST CPL, door BALDUR 3 OAK ST CPL, black VSG glass

Decorative panels are mounted on the wall as a decorative element and at the same time improve the acoustics in the room.

Mounting is possible in several ways - the decorative skirting board can be mounted to the wall by means of a mounting strip only or with the use of adapters which constitute a base for the panels.

Decorative panels are available in the PREMIUM and ST CPL laminates, which can be put together in combinations of your choice.



components of the decorative panel



composition of decorative panels with the skirting board OAK ST CPL

**DECORATIVE STRIP**

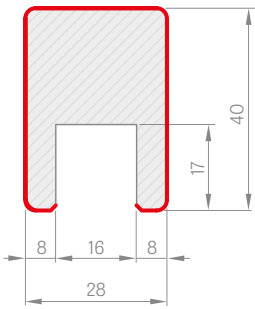

**MOUNTING STRIP**

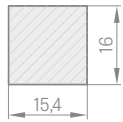

**END STRIP**

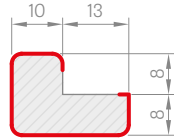

**DECORATIVE PANEL**

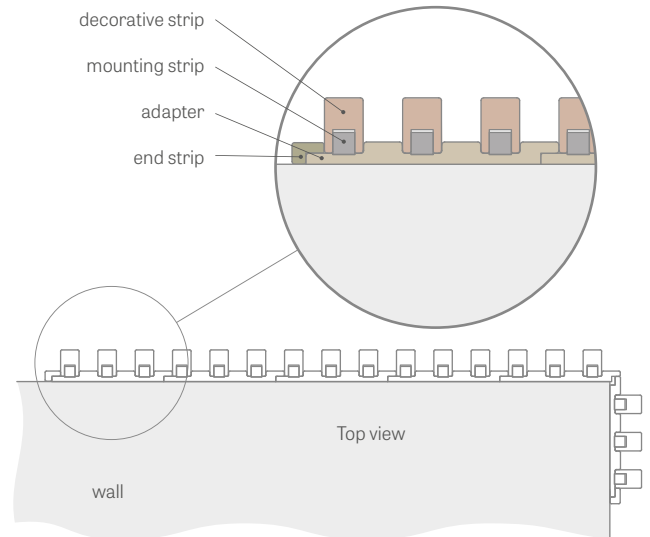

**ADAPTER**

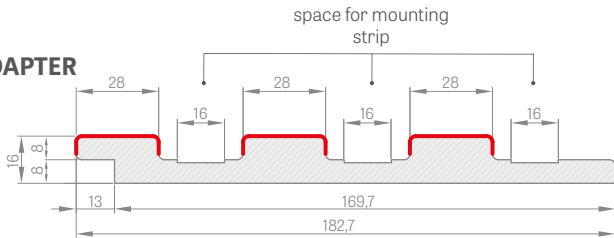

— LAMINATE

adapter, length 2750 mm
decorative strip + mounting strip length 2750 mm
end strip, length 2750 mm

The individual elements of the decorative panel system are commercially available in a length of 2750 mm, however each product has a production length of 2800 mm and is delivered in this length, where 25 mm per side is a margin for free trimming before installation and also a reserve in case of transport damage.

The wall panels can also be mounted without an adapter directly to the wall using only a mounting strip on which we mount the decorative strip.

- adapter - quantity in pack 1 piece
- end strip - package quantity 1 piece
- decorative strip + mounting strip - pack of 3 sets

**PREMIUM**

WALNUT PREMIUM	GREY MAPLE PREMIUM	OAK PREMIUM	WHITE BARK PREMIUM	GRAPHITE ASH PREMIUM
CONCRETE PREMIUM	HORIZONTAL LARCH	NATUR OAK PREMIUM	WHITE PREMIUM 1)	

**CPL**

OAK ST CPL	GREY OAK ST CPL	VENGE ST CPL	GREY PINE ST CPL	WHITE ST CPL 1)2)
CAPPUCCINO ST CPL 2)	LIGHT-GREY ST CPL 2)	BLACK ST CPL 2)		

# SKIRTING BOARDS

**SKIRTING BOARD**

- length: 2.40 running metres.
- the skirting board is made of moisture resistant MDF board. Available variants: WHITE TITANIUM UV paint, laminates: GREKO, ST CPL, PREMIUM and in base laminate to be paint coated.
- fitting method: bonding to wall

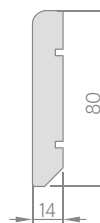

1) plain white laminate imitating a painted surface  
2) special AntiFinger coating to reduce dirt and fingerprints



# UNO PREMIUM

REBATED, NON-REBATED AND REVERSE PAINTED DOORS



Presented model: UNO PREMIUM with black matt CUBE handle

Frame side view: non-rebated door, 8 cm architrave, frame joints at 90°



Frame side view: rebated door, 8 cm architrave, frame joints at 45°



Hinge side view: rebated door, 6 cm architrave, frame joints at 45°



Presented model: UNO PREMIUM with black matt CUBE handle



## CONSTRUCTION

- rebated, non-rebated or reverse door leaf
- internal timber stile (sides and top, bottom -MDF) covered with two HDF boards
- honeycomb stabilising filling or solid core filling against an additional charge
- optionally, against an additional charge, upper panels extending the frame - page 134 **NEW**

## FINISHING

- door leaves and door frames coated with water-based UV hardened varnish for high resistance to adverse use conditions
- door leaf edge made in standard technology

## HARDWARE

- three pin mortise hinges in a rebated door leaf
- three concealed hinges in the non-adjacent leaf and two hinges in the reverse leaf in silver (black against an extra charge); hinges are supplied and priced with the door frame **NEW**
- a deadbolt lock in the rebated door leaf and a key-locked magnetic lock in the non-rebated and reverse door leaves, thumb turn cylinder, economy or silver with a blockade or, optionally, against an additional charge, a black magnetic lock **NEW**

## PAINTED

WHITE TITANIUM UV

## ADDITIONAL CHARGES

### reverse door leaf **NEW**

solid core filling

ventilation cut

"100" rebated and non-rebated door leaf

additional bottom rail (can be cut by customer up to max 8 cm )

metal hinge casings in the rebated door leaf (brushed nickel, patina, polished chrome, polished brass, white and black)

drop-down gasket <sup>1)</sup>

can be replaced with a black magnetic lock for non-rebated and reverse leaves

magnetic stop (buffer) <sup>1)</sup> **NEW**  
(available in six colours p. 132)

stainless steel porthole: "chrome" polished or "satine" brushed; frosted decormat glass, non-tinted glass; porthole ID 235 mm; external 350 mm)

## AVAILABLE SOLUTIONS (pp. 135-143)

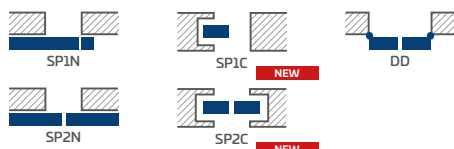

## AVAILABLE DOOR LEAF WIDTHS

60 70 80 90 100

<sup>1)</sup> the stop prevents application of a drop-down gasket and vice versa



# TURAN

REBATED, NON-REBATED PAINTED DOORS



finalista konkursu  
**DOBRY WZÓR**  
2019



TURAN 4, black matt CUBE handle



TURAN 1



TURAN 2



TURAN 3



TURAN 4



TURAN 5



TURAN 6



TURAN 7<sup>1)</sup>

<sup>1)</sup> the photo shows the REVERS version



Presented model: TURAN 5 with black matt CUBE handle



## CONSTRUCTION

- rebated or non-rebated door leaf made in the STILE technology
- timber stiles covered with thin HDF boards and laminated and coated with UV resistant varnish
- 16 mm thick HDF panels, moulded and coated with UV resistant varnish
- optionally, against an additional charge, upper panels extending the frame - page 134 **NEW**

## FINISHING

- door leaves and door frames coated with water-based UV hardened varnish for high resistance to adverse use conditions

## HARDWARE

- rebated door leaves: three silver 2-pin hinges adjusted horizontally
- three concealed hinges in a non-rebated leaf, silver (optionally black - subject to an additional charge); hinges supplied with and included in the price of the door frame **NEW**
- a deadbolt lock in a rebated door leaf and a key-locked magnetic lock in a non-rebated door leaf, thumb turn cylinder, economy, with a silver blockade; optionally, against an additional charge, a black, magnetic lock **NEW**

## GLAZING

- TURAN 1 model, 4 mm tempered glass or, against an additional charge, frosted or black VSG441 laminated safety **NEW** glass, plain on both sides
- TURAN 7 model available with a mirror on one side. Other side - varnished board WHITE TITANIUM UV. Obverse - mirror on the hinge side.

## MOULDING

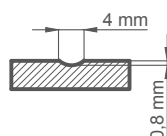

## PAINTED

WHITE TITANIUM UV

## AVAILABLE SOLUTIONS (pp. 135-143)

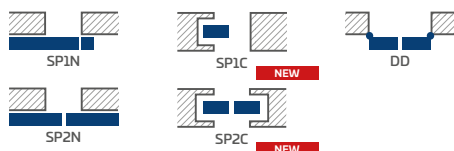

## AVAILABLE DOOR LEAF WIDTHS

60 70 80 90 100

## ADDITIONAL CHARGES

ventilation cut

"100" rebated and non-rebated door leaf

metal hinge casings in the rebated door leaf (brushed nickel, patina, polished chrome, polished brass, white and black)

frosted or black VSG 221 laminated safety glass, **NEW**  
plain on both sides (for TURAN 1)

drop-down gasket<sup>1)</sup>

can be replaced with a black magnetic lock for non-rebated door leaves

magnetic stop (buffer)<sup>1)</sup> **NEW**  
(available in six colours p. 132)

factory-drilled openings for through-mounting applies to double-section handles in our offer, pages 120 to 127 **NEW**

<sup>1)</sup> the stop prevents application of a drop-down gasket and vice versa



# MISKANT

REBATED, NON-REBATED PAINTED DOORS



MISKANT 2, BELLA slim black matt handle



MISKANT 1



MISKANT 2



MISKANT 3



MISKANT 4



MISKANT 5



MISKANT 6

Presented model: MISKANT 2 with a black matt BELLA slim handle



**CONSTRUCTION**

- rebated or non-rebated door leaf made in the STILE technology
- timber stiles covered with thin HDF boards and laminated and coated with UV resistant varnish
- 16 mm thick HDF panels, moulded and coated with UV resistant varnish
- optionally, against an additional charge, upper panels extending the frame - page 134 **NEW**

**FINISHING**

- door leaves and door frames coated with water-based UV hardened varnish for high resistance to adverse use conditions

**HARDWARE**

- rebated door leaves: three silver 2-pin hinges adjusted horizontally
- three concealed hinges in a non-rebated leaf, silver (optionally black - subject to an additional charge); hinges supplied with and included in the price of the door frame **NEW**
- a deadbolt lock in a rebated door leaf and a key-locked magnetic lock in a non-rebated door leaf, thumb turn cylinder, economy, with a silver blockade; optionally, against an additional charge, a black, magnetic lock **NEW**

**GLAZING**

- toughened transparent or frosted glass with a thickness of 4 mm
- possibility to change the glazing side to REVERSE (OBSERVE - standard glazing)
- black lines of 18 mm in width (thickness)

**STANDARD "OBSERVE" GLAZING**



**"REVERSE" GLAZING MADE TO ORDER**



**PAINTED**

WHITE TITANIUM UV

**AVAILABLE SOLUTIONS** (pp. 135-143)

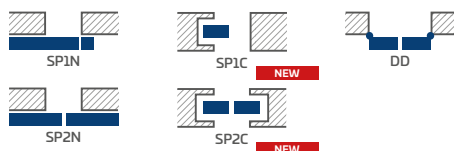

**AVAILABLE DOOR LEAF WIDTHS**

- 60
- 70
- 80
- 90
- 100

**ADDITIONAL CHARGES**

- ventilation cut

---

- "100" rebated and non-rebated door leaf

---

- metal hinge casings in the rebated door leaf (brushed nickel, patina, polished chrome, polished brass, white and black)

---

- drop-down gasket<sup>1)</sup>

---

- can be replaced with a black magnetic lock for non-rebated door leaves

---

- magnetic stop (buffer)<sup>1)</sup> **NEW**  
(available in six colours p. 132)

---

- factory-drilled openings for through-mounting applies to double-section handles in our offer, pages 120 to 127 **NEW**

---

<sup>1)</sup> the stop prevents application of a drop-down gasket and vice versa



# NEMEZJA

REBATED, NON-REBATED PAINTED DOORS



NEMEZJA 6, BELLA handle slim brass glossy



NEMEZJA 1



NEMEZJA 4



NEMEZJA 6



NEMEZJA 7



NEMEZJA 8



NEMEZJA 9



NEMEZJA 10



NEMEZJA 11



NEMEZJA 12



NEMEZJA 13

Presented model: NEMEZJA 6 with a black brass BELLA PREMIUM handle



## PAINTED

WHITE TITANIUM UV

## AVAILABLE SOLUTIONS (pp. 135-143)

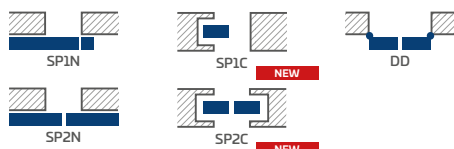

## AVAILABLE DOOR LEAF WIDTHS

60 70 80 90 100

## CONSTRUCTION

- rebated or non-rebated door leaf made in the STILE technology
- timber stiles covered with thin HDF boards and laminated and coated with UV resistant varnish
- 16 mm thick HDF panels, moulded and coated with UV resistant varnish
- optionally, against an additional charge, upper panels extending the frame - page 134 **NEW**

## FINISHING

- door leaves and door frames coated with water-based UV hardened varnish for high resistance to adverse use conditions

## HARDWARE

- rebated door leaves: three silver 2-pin hinges adjusted horizontally
- three concealed hinges in a non-rebated leaf, silver (optionally black - subject to an additional charge); hinges supplied with and included in the price of the door frame **NEW**
- a deadbolt lock in a rebated door leaf and a key-locked magnetic lock in a non-rebated door leaf, thumb turn cylinder, economy, with a silver blockade; optionally, against an additional charge, a black, magnetic lock **NEW**

## GLAZING

- frosted or transparent tempered glass as standard, and custom-made frosted VSG 221 laminated safety glass, plain on both sides
- possibility to change the glazing side to REVERSE (OBVERSE - standard glazing)

## ADDITIONAL CHARGES

ventilation cut

"100" rebated and non-rebated door leaf

metal hinge casings in the rebated door leaf (brushed nickel, patina, polished chrome, polished brass, white and black)

frosted VSG 221 laminated safety glass, plain on both sides

drop-down gasket <sup>1)</sup>

can be replaced with a black magnetic lock for non-rebated door leaves

magnetic stop (buffer) <sup>1)</sup> **NEW**  
(available in six colours p. 132)factory-drilled openings for through-mounting applies to double-section handles in our offer, pages 120 to 127 **NEW**<sup>1)</sup> the stop prevents application of a drop-down gasket and vice versa



# LAURENCJA

REBATED, NON-REBATED PAINTED DOORS



LAURENCJA 1, black VSG glass, matt BELLA handle, black



LAURENCJA 1



LAURENCJA 2



LAURENCJA 3



LAURENCJA 4



LAURENCJA 5



LAURENCJA 6

Presented model: LAURENCJA 1 with a BELLA slim handle, black matt, and VSG 221 laminated glass, black



## PAINTED

WHITE TITANIUM UV

### AVAILABLE SOLUTIONS (pp. 135-143)

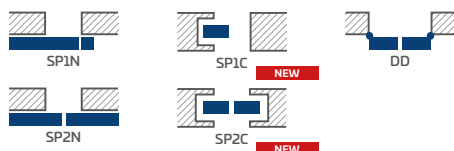

### AVAILABLE DOOR LEAF WIDTHS

60 70 80 90 100

### CONSTRUCTION

- rebated or non-rebated door leaf made in the STILE technology
- timber stiles covered with thin HDF boards and laminated and coated with UV resistant varnish
- 4 mm thick HDF panels, moulded and coated with UV resistant varnish
- optionally, against an additional charge, upper panels extending the frame - page 134 **NEW**

### FINISHING

- door leaves and door frames coated with water-based UV hardened varnish for high resistance to adverse use conditions

### HARDWARE

- rebated door leaves: three silver 2-pin hinges adjusted horizontally
- three concealed hinges in a non-rebated leaf, silver (optionally black - subject to an additional charge); hinges supplied with and included in the price of the door frame **NEW**
- a deadbolt lock in a rebated door leaf and a key-locked magnetic lock in a non-rebated door leaf, thumb turn cylinder, economy, with a silver blockade; optionally, against an additional charge, a black, magnetic lock **NEW**

### GLAZING

- frosted or transparent tempered glass as a standard, and custom-made frosted or black VSG 221 laminated safety glass **NEW** against an additional charge, plain on both sides
- possibility to change the glazing side to REVERSE (OBVERSE - standard glazing)

### ADDITIONAL CHARGES

ventilation cut

"100" rebated and non-rebated door leaf

metal hinge casings in the rebated door leaf (brushed nickel, patina, polished chrome, polished brass, white and black)

frosted or black VSG 221 laminated safety glass, **NEW**  
plain on both sides

drop-down gasket <sup>1)</sup>

can be replaced with a black magnetic lock for non-rebated door leaves

magnetic stop (buffer) <sup>1)</sup> **NEW**  
(available in six colours p. 132)

factory-drilled openings for through-mounting applies to double-section handles in our offer, pages 120 to 127 **NEW**

<sup>1)</sup> the stop prevents application of a drop-down gasket and vice versa



# MILDA

REBATED, NON-REBATED AND REVERSE PAINTED DOORS

produkt rekomendowany  
do konkursu



2019



MILDA 4, CUBE PREMIUM handle, black



MILDA 1



MILDA 2



MILDA 3



MILDA 4



MILDA 5



Presented model: MILDA 2 with a black CUBE PREMIUM handle



## CONSTRUCTION

- rebated, non-rebated or reverse door leaf
- internal timber stile (sides and top, bottom -MDF) covered with two HDF boards
- honeycomb stabilising filling or solid core filling against an additional charge
- optionally, against an additional charge, upper panels extending the frame - page 134 **NEW**

## FINISHING

- door leaves and door frames coated with water-based UV hardened varnish for high resistance to adverse use conditions
- door leaf edge made in standard or non-rebated technology

## HARDWARE

- three pin mortise hinges in a rebated door leaf
- three concealed hinges in the non-adjacent leaf and two hinges in the reverse leaf in silver (black against an extra charge); hinges are supplied and priced with the door frame **NEW**
- a deadbolt lock in the rebated door leaf and a key-locked magnetic lock in the non-rebated and reverse door leaves, thumb turn cylinder, economy or silver with a blockade or, optionally, against an additional charge, a black magnetic lock **NEW**

## MOULDING

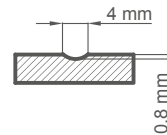

## PAINTED

WHITE TITANIUM UV

## ADDITIONAL CHARGES

reverse door leaf **NEW**

solid core filling

ventilation cut

"100" rebated and non-rebated door leaf

additional bottom rail (can be cut by customer up to max 8 cm)

metal hinge casings in the rebated door leaf (brushed nickel, patina, polished chrome, polished brass, white and black)

drop-down gasket <sup>1)</sup>

can be replaced with a black magnetic lock for non-rebated and reverse leaves

magnetic stop (buffer) <sup>1)</sup> **NEW**  
(available in six colours p. 132)

## AVAILABLE SOLUTIONS (pp. 135-143)

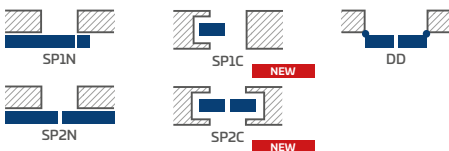

## AVAILABLE DOOR LEAF WIDTHS

60 70 80 90 100

<sup>1)</sup> the stop prevents application of a drop-down gasket and vice versa



# BALDUR

REBATED, NON-REBATED AND REVERSE PAINTED DOORS



BALDUR 1 with a CUBE PREMIUM handle and black VSG 441 laminated glass



BALDUR 1



BALDUR 2



BALDUR 3



BALDUR 4



BALDUR 5



BALDUR 6



BALDUR 7



BALDUR 8

**NEW**

Presented model: BALDUR 7 with a black CUBE PREMIUM handle

**PAINTED**

WHITE TITANIUM UV

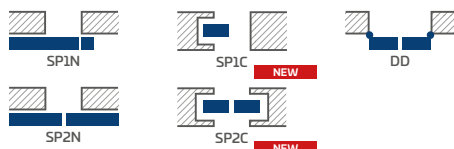
**AVAILABLE SOLUTIONS** <sup>1)3)</sup> (pp. 135-143)**AVAILABLE DOOR LEAF WIDTHS**

60 70 80 90 100

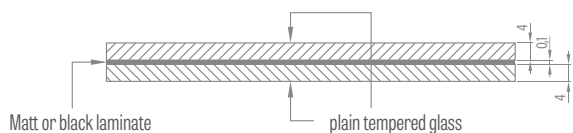
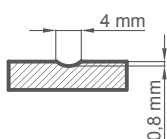
**MOULDING**VSG/ESG laminated and tempered glass as a standard, frosted or black **NEW****CONSTRUCTION**

- rebated, non-rebated or reverse door leaf
- internal timber stile (sides and top, bottom -MDF) covered with two HDF boards
- honeycomb stabilising filling or solid core filling against an additional charge
- optionally, against an additional charge, upper panels extending the frame - page 134 **NEW**

**FINISHING**

- door leaves and door frames coated with water-based UV hardened varnish for high resistance to adverse use conditions
- door leaf edge made in standard or non-rebated technology
- the BALDUR 1 sliding systems have a 17 mm high aluminium or black coloured profile in the lower part of the glass pane

**HARDWARE**

- three pin mortise hinges in a rebated door leaf
- three concealed hinges in the non-adjacent leaf and two hinges in the reverse leaf in silver (black against an extra charge); hinges are supplied and priced with the door frame **NEW**
- a deadbolt lock in the rebated door leaf and a key-locked magnetic lock in the non-rebated and reverse door leaves, thumb turn cylinder, economy or silver with a blockade or, optionally, against an additional charge, a black magnetic lock **NEW**

**GLAZING**

- **BALDUR 1, 3, 5: SG/ESG 441 laminated and tempered safetyglass as a standard, frosted or black, plain on both sides** **NEW**
- fixed glazing widths: BALDUR 1 – 50 mm, BALDUR 3, 5 – 210 mm

**ADDITIONAL CHARGES****reverse door leaf** **NEW**

solid core filling

ventilation cut

"100" rebated and non-rebated door leaf

additional bottom bar to enable the customer to shorten the leaf by themselves  
 drop-down gasket (not for the BALDUR 1, 3, 5 models)

metal hinge casings in the rebated door leaf (brushed nickel, patina, polished chrome, polished brass, white and black)

drop-down gasket <sup>2)</sup> (not for the BALDUR 1, 3, 5 models)

can be replaced with a black magnetic lock for non-rebated and reverse leaves

magnetic stop (buffer) <sup>2)</sup> **NEW**  
 (available in six colours p. 132)

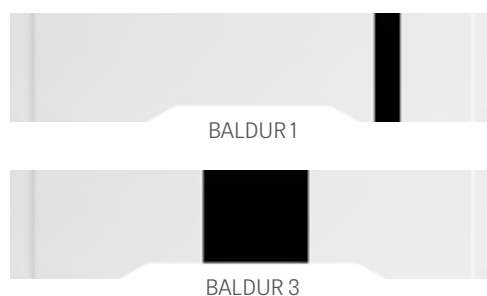
**VENTILATION CUT**

<sup>1)</sup> the BALDUR 1, 3, 5 models are not available with sliding systems or double-leaf doors

<sup>2)</sup> the stop prevents application of a drop-down gasket and vice versa

<sup>3)</sup> the BALDUR 1 model is not available with pocket systems



# ANUBIS

REBATED, NON-REBATED AND REVERSE PAINTED DOORS



ANUBIS 2, handle: BELLA slim, shiny barass



ANUBIS 1



ANUBIS 2



ANUBIS 3



ANUBIS 4



ANUBIS 5

Presented model: ANUBIS 3 with a black brass BELLA handle



## CONSTRUCTION

- rebated, non-rebated or reverse door leaf
- internal timber stile (sides and top, bottom -MDF) covered with two HDF boards
- honeycomb stabilising filling or solid core filling against an additional charge
- optionally, against an additional charge, upper panels extending the frame - page 134 **NEW**

## FINISHING

- door leaves and door frames coated with water-based UV hardened varnish for high resistance to adverse use conditions
- door leaf edge made in standard or non-rebated technology

## HARDWARE

- three pin mortise hinges in a rebated door leaf
- three concealed hinges in the non-adjacent leaf and two hinges in the reverse leaf in silver (black against an extra charge); hinges are supplied and priced with the door frame **NEW**
- a deadbolt lock in the rebated door leaf and a key-locked magnetic lock in the non-rebated and reverse door leaves, thumb turn cylinder, economy or silver with a blockade or, optionally, against an additional charge, a black magnetic lock **NEW**

## MOULDING

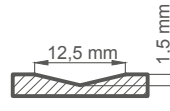

## PAINTED



WHITE TITANIUM UV

## AVAILABLE SOLUTIONS (pp. 135-143)

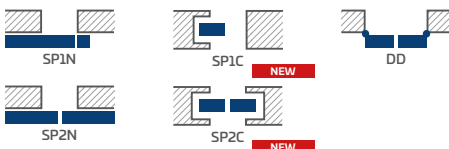

## AVAILABLE DOOR LEAF WIDTHS

60 70 80 90 100

## ADDITIONAL CHARGES

### reverse door leaf **NEW**

solid core filling

ventilation cut

"100" rebated and non-rebated door leaf

additional bottom rail (can be cut by customer up to max 8 cm)

metal hinge casings in the rebated door leaf (brushed nickel, patina, polished chrome, polished brass, white and black)

drop-down gasket <sup>1)</sup>

can be replaced with a black magnetic lock for non-rebated and reverse leaves

magnetic stop (buffer) <sup>1)</sup> **NEW**

(available in six colours p. 132)

<sup>1)</sup> the stop prevents application of a drop-down gasket and vice versa



# SYLENA

REBATED, NON-REBATED AND REVERSE PAINTED DOORS



SYLENA 2, CUBE handle, black, matt



SYLENA 1



SYLENA 2



SYLENA 3



SYLENA 4



SYLENA 5



SYLENA 6



SYLENA 7



SYLENA 8

Presented model: SYLENA 7 with a black matt CUBE handle



## CONSTRUCTION

- rebated, non-rebated or reverse door leaf
- internal timber stile (sides and top, bottom -MDF) covered with two HDF boards
- honeycomb stabilising filling or solid core filling against an additional charge
- optionally, against an additional charge, upper panels extending the frame - page 134 **NEW**

## FINISHING

- door leaves and door frames coated with water-based UV hardened varnish for high resistance to adverse use conditions
- door leaf edge made in standard or non-rebated technology

## HARDWARE

- three pin mortise hinges in a rebated door leaf
- three concealed hinges in the non-adjacent leaf and two hinges in the reverse leaf in silver (black against an extra charge); hinges are supplied and priced with the door frame **NEW**
- a deadbolt lock in the rebated door leaf and a key-locked magnetic lock in the non-rebated and reverse door leaves, thumb turn cylinder, economy or silver with a blockade or, optionally, against an additional charge, a black magnetic lock **NEW**

## MOULDING

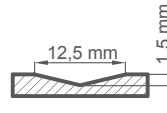

## PAINTED



WHITE TITANIUM UV

## AVAILABLE SOLUTIONS (pp. 135-143)

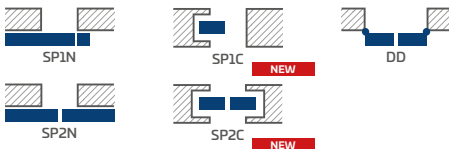

## AVAILABLE DOOR LEAF WIDTHS

60 70 80 90 100

## ADDITIONAL CHARGES

### reverse door leaf **NEW**

solid core filling

ventilation cut

"100" rebated and non-rebated door leaf

additional bottom rail (can be cut by customer up to max 8 cm )

metal hinge casings in the rebated door leaf (brushed nickel, patina, polished chrome, polished brass, white and black)

drop-down gasket <sup>1)</sup>

can be replaced with a black magnetic lock for non-rebated and reverse leaves

magnetic stop (buffer) <sup>1)</sup> **NEW**

(available in six colours p. 132)

<sup>1)</sup> the stop prevents application of a drop-down gasket and vice versa

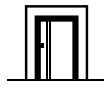

# INLAYS

DECORATIVE INSERT FLUSH WITH THE LAMINATE SURFACE

## LUX INLAY OAK



inlay LUX 313



inlay LUX 312



inlay LUX 304



inlay LUX 303



inlay LUX 316

## LUX INLAY BLACK



inlay LUX 213



inlay LUX212



inlay LUX204



inlay LUX 203



inlay LUX216

## LUX INLAY BRUSHED STEEL



inlay LUX 113



inlay LUX 112



inlay LUX 104



inlay LUX 103



inlay LUX 116





inlay LUX 314



inlay LUX 307



inlay LUX 309

Door frame OAK CPL 0,2 leaf WHITE ST CPL



inlay LUX 214



inlay LUX 207



inlay LUX 209

door frame: BLACK ST CPL door leaf: NATUR OAK PREMIUM



inlay LUX 315  
door frame OAK CPL 0,2  
door leaf WHITE ST CPL



inlay LUX 114



inlay LUX 107



inlay LUX 109

door frame and leaf: LIGHT-GREY ST CPL

**INLAYS** are located on both sides of the leaf and are flush with its surface.  
The inlay width is 8 mm and 220 mm (LUX 315 inlay).

Available colours of the LUX INLAY:  
brushed steel, black, oak (compatible with OAK CPL 0,2 and 0,7).

The presented INLAYS can be optionally used in the following models against an additional charge:

- UNO PREMIUM laminate
- ALTAMURA 1
- FORTECA RC2 & RC3
- HERSE SET 32 dB
- HERSE SET AKUSTIC 39 dB
- LEDA EI30, EI60
- HYPERION EI30 RC2



# UNO PREMIUM

REBATED, NON-REBATED AND REVERSE INTERIOR DOORS



UNO PREMIUM inlay 313, door-leaf with WHITE PREMIUM laminate, door-frame laminate OAK CPL, LUNA PREMIUM handle round, black matt

Presented model: UNO PREMIUM with WALNUT PREMIUM laminate and a CUBE handle



Presented model: UNO PREMIUM in OAK PREMIUM finish with CUBE handle



Presented model: UNO PREMIUM with NATUR OAK PREMIUM laminate and a CUBE handle



## CONSTRUCTION

- rebated, non-rebated or reverse door leaf
- internal timber stile (sides and top, bottom -MDF) covered with two HDF boards
- stabilizing "honeycomb" filling
- solid core filling, against an additional charge
- optionally, against an additional charge, upper panels extending the frame - page 134

**NEW**

## FINISHING

- HDF board with PREMIUM laminate
- door leaf edge made in standard rebated or non-rebated technology
- the edge laminated in the same colour as the door leaf surface or, optionally, in plain black (the decor options include transverse larch with a black edge with a horizontal structure)
- inserts (inlay) colour: brushed steel, black and OAK CPL with a width of 8 mm or 200 mm (LUX inlay315) flush with the leaf, on both sides of the leaf

## HARDWARE

- three pin mortise hinges in a rebated door leaf
- three concealed hinges in the non-adjacent leaf and two hinges in the reverse leaf in silver (black against an extra charge); hinges are supplied and priced with the door frame
- bolt lock in the rebate leaf and a magnetic lock in the non-rebate and reverse leaf: with a key, thumb turn cylinder, economy or with silver, with a blockade; optionally, against an extra charge, a black magnetic lock

**NEW**

## AVAILABLE SOLUTIONS (pp. 135-143)

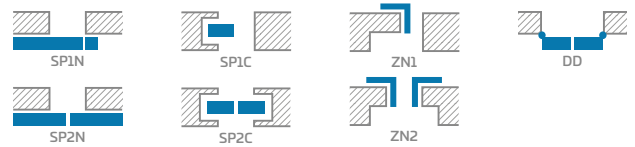

## ADDITIONAL CHARGES

reverse door leaf **NEW**

solid core filling

door closer reinforcement

arm door closer (silver, black, white, brown)

additional bottom bar (can be cut by customer up to max 8 cm )

round and square metal sleeves (4 pcs);  
brushed nickel or patina finish, white and black

plastic woodgrain sleeves (4 pcs)

ventilation door cut or grille

"100" rebated and non-rebated door leaf

"110" rebated and non-rebated door leaf

drop-down gasket <sup>2)</sup>

metal hinge casings in the rebated door leaf (brushed nickel, patina, polished chrome, polished brass, white and black)

stainless steel porthole: "chrome" polished or "satine" brushed; frosted decormat glass, non-tinted glass; porthole ID 235 mm external 350 mm)

black door leaf edge finish

can be replaced with a black magnetic lock for non-rebated and reverse leaves

magnetic stop (buffer) <sup>2)</sup> **NEW**  
(available in six colours p. 132)

LUX inlay; available versions p. 80-81

## PREMIUM

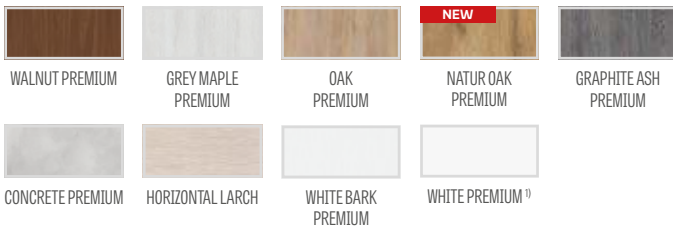

## AVAILABLE DOOR LEAF WIDTHS

60 70 80 90 100 110

## EDGE FINISH TYPES



<sup>1)</sup> plain white laminate imitating a painted surface

<sup>2)</sup> the stop prevents application of a drop-down gasket and vice versa



# BALDUR

REBATED, NON-REBATED AND REVERSE INTERIOR DOORS

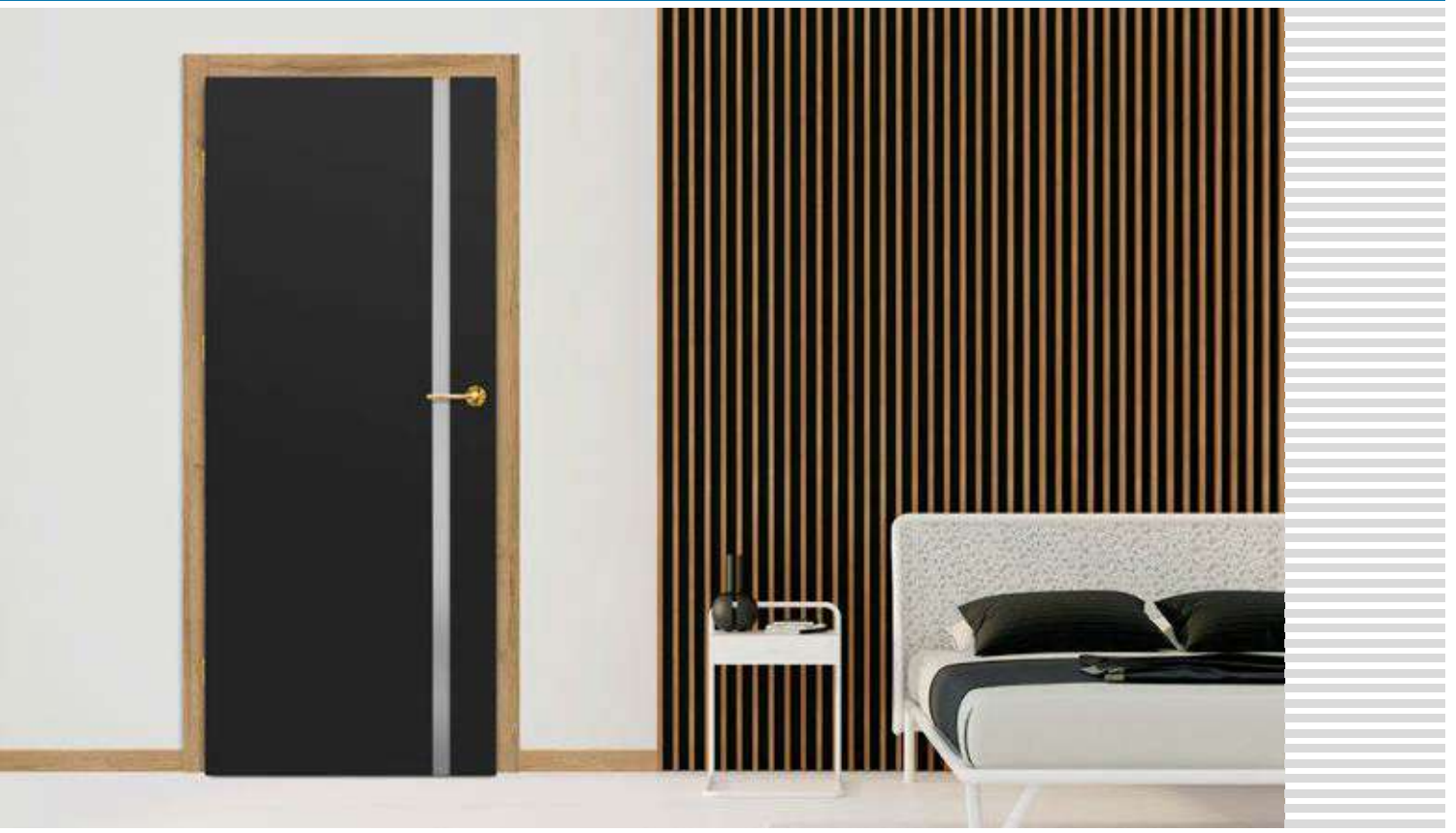

BALDUR 1, leaf laminate BLACK ST CPL, frame laminate OAK NATUR PREMIUM, handle BELLA brass glossy



BALDUR 1



BALDUR 3

BALDUR 3, leaf laminate BLACK ST CPL, frame laminate OAK NATUR PREMIUM, handle BELLA brass glossy



## CONSTRUCTION

- rebated, non-rebated or reverse door leaf
- internal timber stile (sides and top, bottom -MDF) covered with two HDF boards
- honeycomb stabilising filling or solid core filling against an additional charge
- optionally, against an additional charge, upper panels extending the frame - page 134

**NEW**

## FINISHING

- HDF board in PREMIUM or CPL laminate
- leaf edge made in the standard rebated or non-rebated technology with CPL 0.2 laminates, laminated with the ABS edging, and in the same colour as the leaf only or; against an additional charge, with a standard black edge
- reverse door leaf only in with the STANDARD edge and with the GREKO, PREMIUM and ST CPL decors
- The edge laminated in the same colour as the door leaf surface or, optionally, in plain black (transverse larch, black edge with a transverse structure) black, partial edge finish (two vertical and a top one) and by the glass.
- door-leaf BALDUR 1 rebated and non-rebated only for the WHITE ST CPL decor made optionally in the soft technology (no visible longitudinal laminate joints)
- the BALDUR 1 sliding systems have a 17 mm high aluminium or black coloured profile in the lower part of the glass pane

**NEW**

## HARDWARE

- two pin mortise hinges or three hinges (PREMIUM finish) in a rebated door leaf
- three concealed hinges in the non-adjacent leaf and two hinges in the reverse leaf in silver (black against an extra charge); hinges are supplied and priced with the door frame
- a deadbolt lock in the rebated door leaf and a key-locked magnetic lock in the non-rebated and reverse door leaves, thumb turn cylinder, economy or silver with a blockade or, optionally, against an additional charge, a black magnetic lock

**NEW**

**NEW**

## GLAZING

- BALDUR 1, 3: 8 mm tempered frosted glass or VSG/ESG 441 safety glass, frosted or black

**NEW**

## AVAILABLE DOOR LEAF WIDTHS

60 70 80 90 100

## ADDITIONAL CHARGES

reverse door leaf **NEW**  
(not available with CPL 0.2 finishing and for Baldur 1 with 'SOFT' edge)

solid core filling

ventilation cut

"100" rebated and non-rebated door leaf

additional hinge in the rebated door leaf and used always as per Czech standard (not applicable to solid core board, GREKO & PREMIUM decors and the "100" leaf)

frosted or black VSG/ESG 441 glazing

metal hinge casings in the rebated door leaf (brushed nickel, patina, polished chrome, polished brass, white and black)

black door leaf edge finish **NEW**

can be replaced with a black magnetic lock for non-rebated and reverse leaves

magnetic stop (buffer) **NEW**

(available in six colours p. 132)

## VENTILATION CUT

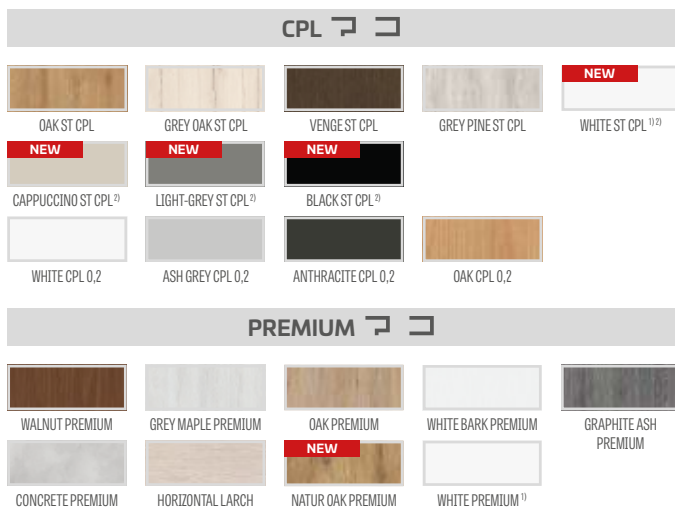
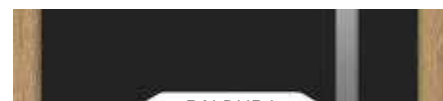

## AVAILABLE SOLUTIONS <sup>3)</sup> (pp. 135-143)



## EDGE FINISH TYPES

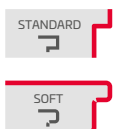

BLACK PLAIN DOOR LEAF EDGE FINISH

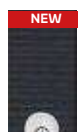

BLACK HORIZONTAL DOOR LEAF EDGE FINISH

<sup>1)</sup> plain white laminate imitating a painted surface

<sup>2)</sup> special AntiFinger coating to reduce dirt and fingerprints **NEW**

<sup>3)</sup> the BALDUR 3 model not available in sliding systems or double-leaf doors

<sup>4)</sup> only BALDUR 1 rebated and non-rebated in WHITE ST CPL laminate



# BALDUR

REBATED, NON-REBATED AND REVERSE INTERIOR DOORS



BALDUR 3, laminate CAPPUCCINO ST CPL, handle CUBE

Presented model: BALDUR 1 in LIGHT GREY ST CPL finish with a CUBE handle



Presented model: BALDUR 3 with WHITE ST CPL laminate and a CUBE handle



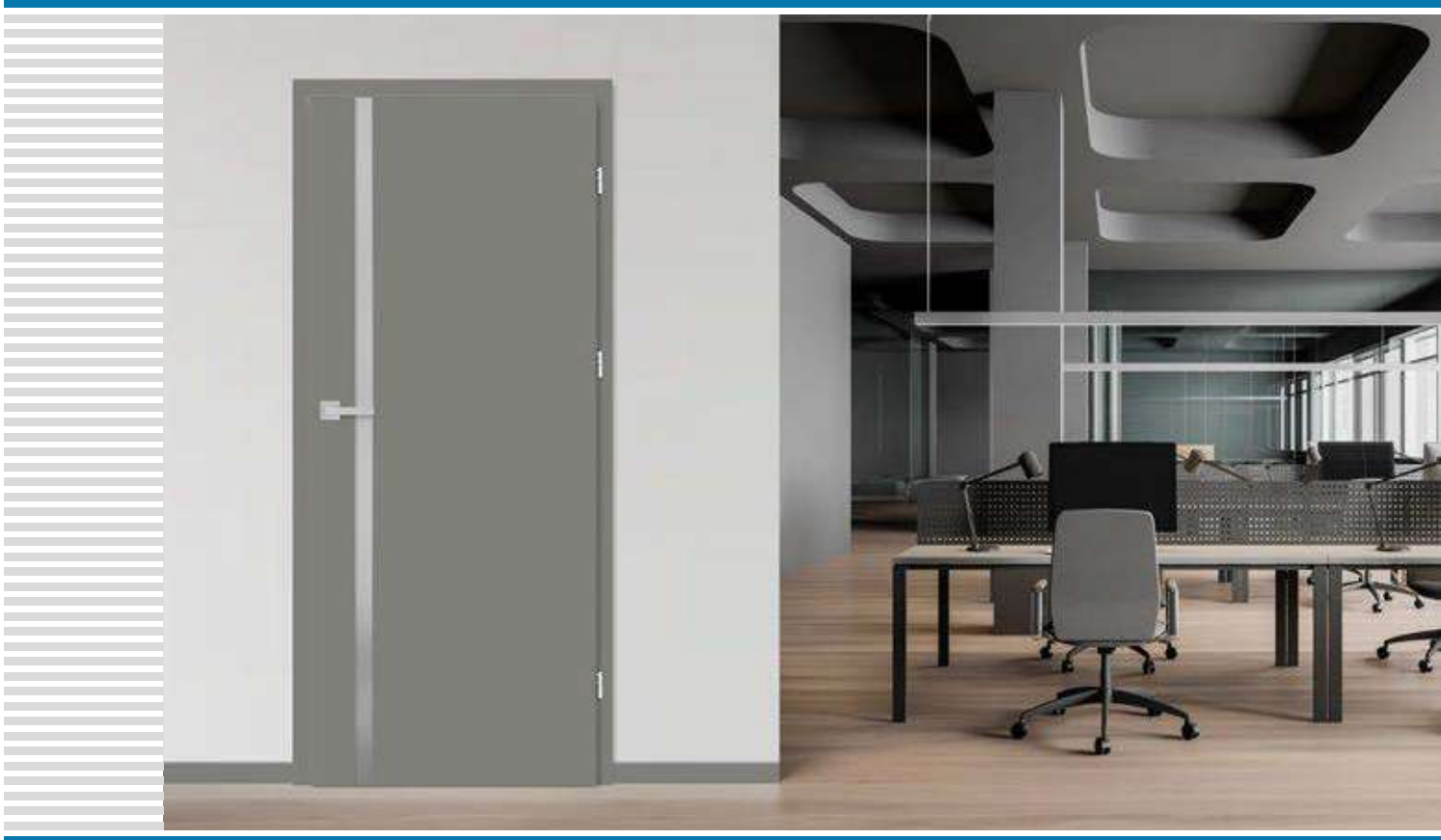

BALDUR 1, LIGHT-GREY ST CPL laminate, TOPAZ INOX handle

Presented model: BALDUR 1 with CAPPUCCINO ST CPL laminate and a TOPAZ INOX handle



Presented model: BALDUR 3 with NATUR OAK PREMIUM laminate and a TOPAZ INOX handle





# ALTAMURA

REBATED, NON-REBATED AND REVERSE INTERIOR DOORS



ALTAMURA 5, laminate OAK ST CPL, LINEA handle



ALTAMURA 1



ALTAMURA 2



ALTAMURA 3



ALTAMURA 4



ALTAMURA 5



ALTAMURA 6



ALTAMURA 7



ALTAMURA 8



Middle panel



grille panel



Bottom panel



## CONSTRUCTION

- rebated, non-rebated or reverse door leaf
- MDF stiles and rails covered with two HDF boards in GREKO and FINISH laminates
- internal timber stile (sides and top, bottom -MDF) covered with two HDF boards in CPL and PREMIUM laminate
- honeycomb stabilising filling or solid core filling against an additional charge
- optionally, against an additional charge, upper panels extending the frame - page 134

**NEW**

## FINISHING

- laminated HDF board
- door leaf edge made in the SOFT (FINISH & GREKO) or the STANDARD (FINISH, GREKO, PREMIUM & CPL) technology
- CPL 0.2 & 0.7 laminates available only with the STANDARD edge with the ABS edging in the same colour as the door leaf only or, against an additional charge, with a standard black edge
- reverse door leaf only in the STANDARD edge and in GREKO, PREMIUM and ST CPL decors
- edge (in STANDARD or non-rebated finish) laminated in edging in the same colour as the surface or, optionally, in plain black (black edging with transverse larch decor and a black edge with a transverse structure)
- for ALTAMURA 1 double-sided inlays available against an additional charge, as shown on pages 80-81

## HARDWARE

- two pin mortise hinges or three hinges (GREKO & PREMIUM decors) in a rebated door leaf
- three concealed hinges in the non-adjacent leaf and two hinges in the reverse leaf in silver (black against an extra charge); hinges are supplied and priced with the door frame

**NEW**

- a deadbolt lock in the rebated door leaf and a key-locked magnetic lock in the non-rebated and reversed door leaves, thumb turn cylinder, economy or silver with a blockade or, optionally, against an additional charge, a black magnetic lock

**NEW**

## GLAZING

- frosted decormat glass as standard, transparent or, charged extra, frosted VSG 221 safety glass, plain on both sides
- possibility to change the glazing side to REVERSE (OBSERVE - standard glazing)

## ADDITIONAL CHARGES

reverse door leaf **NEW** (unavailable for CPL 0,2 and 0,7)

solid core filling (price includes a third hinge used in the rebated door leaf as standard)

door closer reinforcement

arm door closer (silver, black, white, brown)

additional bottom bar (can be cut by customer up to max 8 cm)

ventilation door cut or grille

metal round or square ventilation sleeves (4 pcs);  
brushed nickel or patina finish in white or black

plastic sleeves

rebated and non-rebated leaf "100" rebated and non-rebated leaf "110"  
solid core filling (price includes a third hinge used in the rebated door leaf as standard)

frosted VSG 221 laminated glass

additional hinge in the rebated door leaf and used always as per Czech standard (not applicable to solid core leaf, GREKO & PREMIUM decors and "100" leaf)

drop-down gasket<sup>3)</sup>

metal hinge casings in the rebated door leaf (brushed nickel, patina, polished chrome, polished brass, white and black)

ALTAMURA 1: stainless steel porthole: polished "chrome" or brushed "satin" and black matt;  
frosted decormat glass, non-tinted glass; portholediameter: internal: 235 mm;  
external 350 mm)

stainless steel panel (fitted on both sides in the rebated STANDARD door leaves only),  
height 300 mm

black door leaf edge finish **NEW**

can be replaced with a black magnetic lock for non-rebated and reverse leaves

magnetic stop (buffer)<sup>3)</sup> **NEW**

(available in six colours p. 132)

ALTAMURA 1 model: LUX inlay; available versions p. 80-81

### FINISH



WALNUT FINISH

LIGHT ACACIA FINISH

ACACIA FINISH

### GREKO

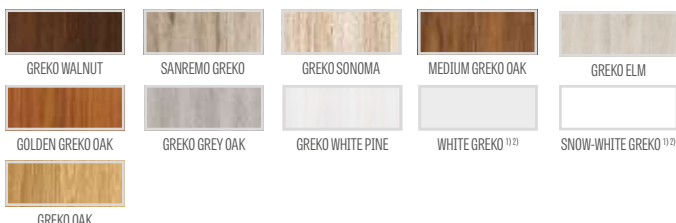

GREKO WALNUT

SANREMO GREKO

GREKO SONOMA

MEDIUM GREKO OAK

GREKO ELM

GOLDEN GREKO OAK

GREKO GREY OAK

GREKO WHITE PINE

WHITE GREKO<sup>1)2)</sup>

SNOW-WHITE GREKO<sup>1)2)</sup>

GREKO OAK

### CPL

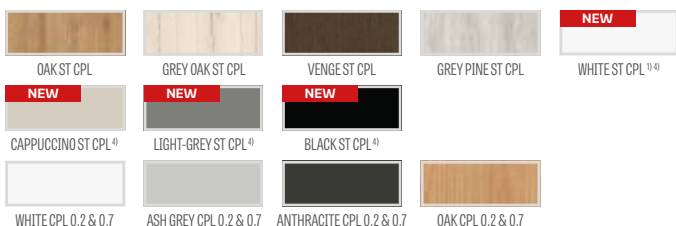

OAK ST CPL

GREY OAK ST CPL

VENGE ST CPL

GREY PINE ST CPL

WHITE ST CPL<sup>1)4)</sup>

CAPPUCCINO ST CPL<sup>4)</sup>

LIGHT-GREY ST CPL<sup>4)</sup>

BLACK ST CPL<sup>4)</sup>

WHITE CPL 0.2 & 0.7

ASH GREY CPL 0.2 & 0.7

ANTHRACITE CPL 0.2 & 0.7

OAK CPL 0.2 & 0.7

### PREMIUM

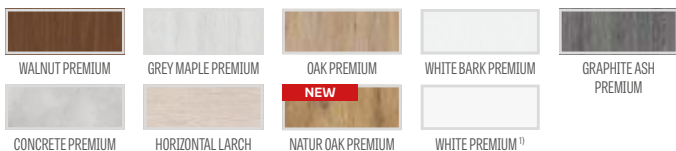

WALNUT PREMIUM

GREY MAPLE PREMIUM

OAK PREMIUM

WHITE BARK PREMIUM

GRAPHITE ASH PREMIUM

CONCRETE PREMIUM

HORIZONTAL LARCH

NATUR OAK PREMIUM

WHITE PREMIUM<sup>1)</sup>

## AVAILABLE DOOR LEAF WIDTHS

60 70 80 90 100 110

## GLASS FRAME



## AVAILABLE SOLUTIONS (pp. 135-143)

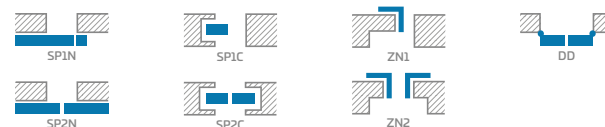

## EDGE FINISH TYPES

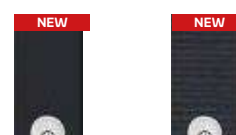
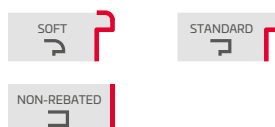

BLACK PLAIN DOOR LEAF EDGE FINISH

BLACK HORIZONTAL DOOR LEAF EDGE FINISH

<sup>1)</sup> plain white laminate imitating a painted surface

<sup>2)</sup> available only in STANDARD

<sup>3)</sup> the stop prevents application of a drop-down gasket and vice versa

<sup>4)</sup> special AntiFinger coating **NEW** to reduce dirt and fingerprints



# ANSEDONIA

REBATED, NON-REBATED AND REVERSE INTERIOR DOORS



GREY OAK ST CPL laminate, TOPAZ INOX handle



ANSEDONIA 1



ANSEDONIA 2



ANSEDONIA 3



ANSEDONIA 4



ANSEDONIA 5



ANSEDONIA 6



ANSEDONIA 7



ANSEDONIA 8



ANSEDONIA 9



ANSEDONIA 10



ANSEDONIA 11



ANSEDONIA 12

## CONSTRUCTION

- rebated, non-rebated or reverse door leaf
- MDF stiles and rails covered with two HDF boards in GREKO and FINISH laminates
- internal timber stile (sides and top, bottom -MDF) covered with two HDF boards in CPL and PREMIUM laminate
- honeycomb stabilising filling or solid core filling against an additional charge
- optionally, against an additional charge, upper panels extending the frame - page 134

**NEW**

## FINISHING

- laminated HDF board
- door leaf edge made in the SOFT or STANDARD technology.
- CPL 0.2 & 0.7 laminates available only with the STANDARD edge with the ABS edging in the same colour as the door leaf only or, against an additional charge, with a standard black edge
- reverse door leaf only in the STANDARD edge and in GREKO, PREMIUM and ST CPL decors
- edge (in STANDARD or non-rebated finish) laminated in edging in the same colour as the surface or, optionally, in plain black (black edging with transverse larch decor and a black edge with a transverse structure)

## HARDWARE

- two pin mortise hinges or three hinges (GREKO & PREMIUM decors) in a rebated door leaf
- three concealed hinges in the non-adjacent leaf and two hinges in the reverse leaf in silver (black against an extra charge); hinges are supplied and priced with the door frame

**NEW**

- bolt lock in the rebated leaf and magnetic lock in the non-rebated leaf and reverse leaf: with a key, thumb turn, economy or with silver; with a blockade; optionally, against an extra charge, a black magnetic lock

**NEW**

## GLAZING

- frosted decormat glass as standard**, transparent or, charged extra, frosted VSG 221 safety glass, plain on both sides
- possibility to change the glazing side to REVERSE (OBERSE - standard glazing)

## ADDITIONAL CHARGES

**reverse door leaf** **NEW**  
(not available in CPL 0.2 & 0.7)

solid core filling (price includes a third hinge used in the rebated door leaf as standard)

door closer reinforcement

arm door closer (silver, black, white, brown)

additional bottom bar (can be cut by customer up to max 8 cm)

ventilation door cut or grille

plastic sleeves

metal round or square ventilation sleeves (4 pcs);  
brushed nickel or patina finish in white or black

"100" rebated and non-rebated door leaf (price includes a third hinge used in the door leaf as standard)

frosted VSG 221 laminated glass, plain on both sides

additional hinge in the rebated door leaf and used always as per Czech standard (not applicable to solid core leaf, GREKO & PREMIUM decors and "100" leaf)

drop-down gasket <sup>3)</sup>

metal hinge casings in the rebated door leaf (brushed nickel, patina, polished chrome, polished brass, white and black)

black door leaf edge finish **NEW**

can be replaced with a black magnetic lock for non-rebated and reverse leaves

magnetic stop (buffer) <sup>3)</sup> **NEW**  
(available in six colours p. 132)

### FINISH



WALNUT FINISH

LIGHT ACACIA FINISH

ACACIA FINISH

### GREKO

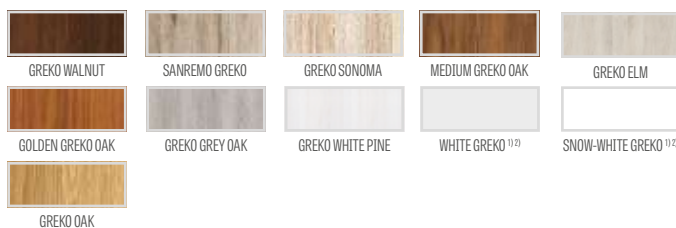

GREKO WALNUT

SANREMO GREKO

GREKO SONOMA

MEDIUM GREKO OAK

GREKO ELM

GOLDEN GREKO OAK

GREKO GREY OAK

GREKO WHITE PINE

WHITE GREKO <sup>1)</sup>

SNOW-WHITE GREKO <sup>1)</sup>

GREKO OAK

### CPL

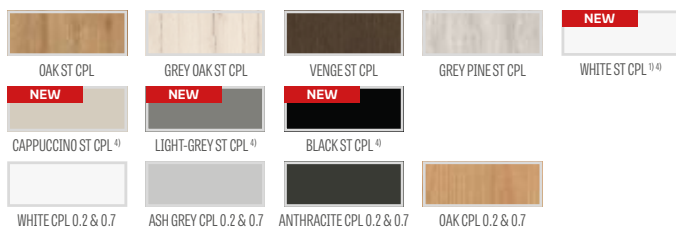

OAK ST CPL

GREY OAK ST CPL

VENGE ST CPL

GREY PINE ST CPL

WHITE ST CPL <sup>1)</sup>

CAPPUCCINO ST CPL <sup>4)</sup>

LIGHT-GREY ST CPL <sup>4)</sup>

BLACK ST CPL <sup>4)</sup>

WHITE CPL 0.2 & 0.7

ASH GREY CPL 0.2 & 0.7

ANTHRACITE CPL 0.2 & 0.7

OAK CPL 0.2 & 0.7

### PREMIUM

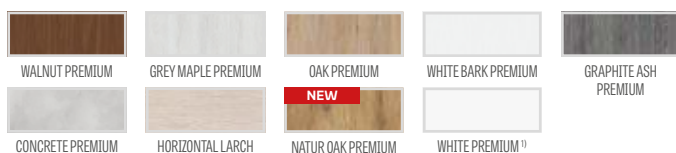

WALNUT PREMIUM

GREY MAPLE PREMIUM

OAK PREMIUM

WHITE BARK PREMIUM

GRAPHITE ASH PREMIUM

CONCRETE PREMIUM

HORIZONTAL LARCH

NATUR OAK PREMIUM

WHITE PREMIUM <sup>1)</sup>

## AVAILABLE DOOR LEAF WIDTHS

60 70 80 90 100

## GLASS FRAME



## AVAILABLE SOLUTIONS (pp. 135-143)

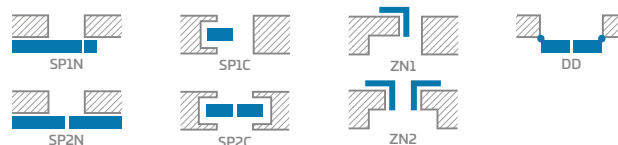

## EDGE FINISH TYPES

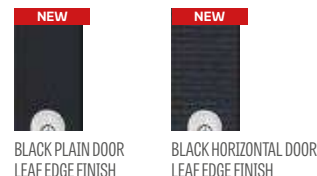
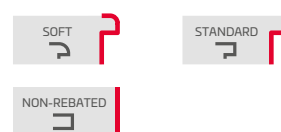

BLACK PLAIN DOOR LEAF EDGE FINISH

BLACK HORIZONTAL DOOR LEAF EDGE FINISH

<sup>1)</sup> plain white laminate imitating a painted surface

<sup>2)</sup> available only in STANDARD

<sup>3)</sup> the stop prevents application of a drop-down gasket and vice versa

<sup>4)</sup> special AntiFinger coating **NEW** to reduce dirt and fingerprints



# LORIENT

REBATED, NON-REBATED AND REVERSE INTERIOR DOORS



LORIENT 1, GREY MAPLE PREMIUM laminate, TOPAZ INOX handle



LORIENT 1



LORIENT 2



LORIENT 3



LORIENT 4



LORIENT 5



LORIENT 6



LORIENT 7



LORIENT 8



LORIENT 9



LORIENT 10



LORIENT 11



LORIENT 12

## CONSTRUCTION

- rebated, non-rebated or reverse door leaf
- MDF stiles and rails covered with two HDF boards in GREKO and FINISH laminates
- internal timber stile (sides and top, bottom -MDF) covered with two HDF boards in CPL and PREMIUM laminate
- honeycomb stabilising filling or solid core filling against an additional charge
- optionally, against an additional charge, upper panels extending the frame - page 134

**NEW**

## FINISHING

- laminated HDF board
- door leaf edge made in the SOFT or STANDARD technology.
- reverse door leaf only in the STANDARD edge and in GREKO, PREMIUM and ST CPL decors
- edge (in STANDARD or non-rebated finish) laminated in edging in the same colour as the surface or, optionally, in plain black (black edging with transverse larch decor and a black edge with a transverse structure)

## HARDWARE

- two pin mortise hinges or three hinges (GREKO & PREMIUM decors) in a rebated door leaf
- three concealed hinges in the non-adjacent leaf and two hinges in the reverse leaf in silver (black against an extra charge); hinges are supplied and priced with the door frame

**NEW**

- bolt lock in the rebated leaf and magnetic lock in the non-rebated leaf and reverse leaf: with a key, thumb turn, economy or with silver, with a blockade; optionally, against an extra charge, a black magnetic lock

**NEW**

## GLAZING

- frosted decormat glass as standard, transparent or, charged extra, frosted VSG 221 safety glass, plain on both sides
- possibility to change the glazing side to REVERSE (OBSERVE - standard glazing)

## ADDITIONAL CHARGES

### reverse door leaf **NEW**

solid core filling (price includes a third hinge used in the rebated door leaf as standard)

door closer reinforcement

arm door closer (silver, black, white, brown)

additional bottom bar (can be cut by customer up to max 8 cm)

ventilation door cut or grille

plastic sleeves

metal round or square ventilation sleeves (4 pcs);  
brushed nickel or patina finish in white or black

"100" rebated and non-rebated door leaf (price includes a third hinge used in the door leaf as standard)

frosted VSG 221 laminated glass, plain on both sides

additional hinge in the rebated door leaf and used always as per Czech standard (not applicable to solid core leaf, GREKO & PREMIUM decors and "100" leaf)

drop-down gasket<sup>3)</sup>

metal hinge casings in the rebated door leaf (brushed nickel, patina, polished chrome, polished brass, white and black)

black door leaf edge finish **NEW**

can be replaced with a black magnetic lock for non-rebated and reverse leaves

magnetic stop (buffer)<sup>3)</sup> **NEW**

(available in six colours p. 132)

## FINISH



WALNUT FINISH

LIGHT ACACIA FINISH

ACACIA FINISH

## GREKO

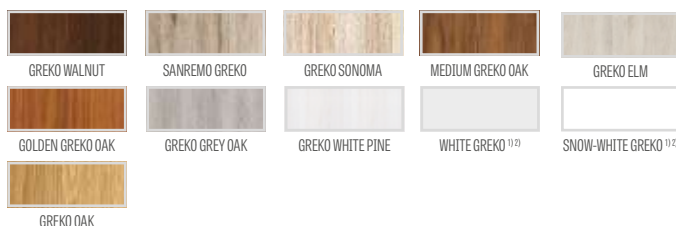

GREKO WALNUT

SANREMO GREKO

GREKO SONOMA

MEDIUM GREKO OAK

GREKO ELM

GOLDEN GREKO OAK

GREKO GREY OAK

GREKO WHITE PINE

WHITE GREKO<sup>1)2)</sup>

SNOW-WHITE GREKO<sup>1)2)</sup>

GREKO OAK

## CPL

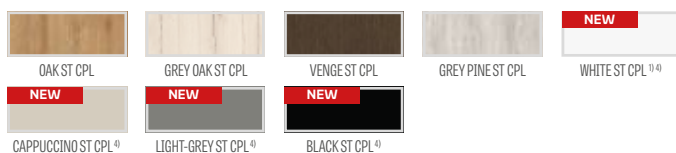

OAK ST CPL

GREY OAK ST CPL

VENGE ST CPL

GREY PINE ST CPL

WHITE ST CPL<sup>1)4)</sup>

CAPPUCCINO ST CPL<sup>4)</sup>

LIGHT-GREY ST CPL<sup>4)</sup>

BLACK ST CPL<sup>4)</sup>

## PREMIUM

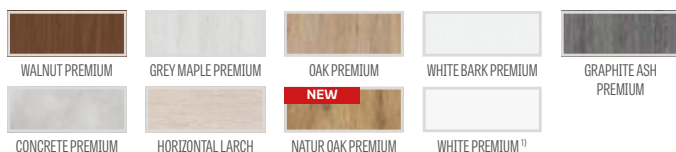

WALNUT PREMIUM

GREY MAPLE PREMIUM

OAK PREMIUM

WHITE BARK PREMIUM

GRAPHITE ASH PREMIUM

CONCRETE PREMIUM

HORIZONTAL LARCH

NATUR OAK PREMIUM

WHITE PREMIUM<sup>1)</sup>

## AVAILABLE DOOR LEAF WIDTHS

60 70 80 90 100

## GLASS FRAME

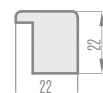

## AVAILABLE SOLUTIONS (pp. 135-143)

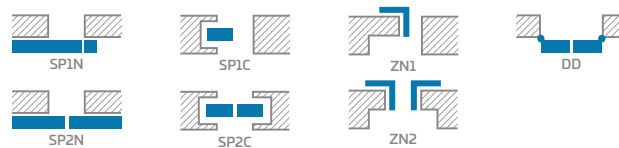

## EDGE FINISH TYPES

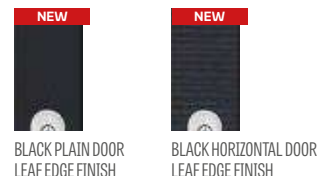
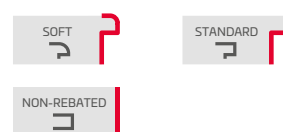

<sup>1)</sup> plain white laminate imitating a painted surface

<sup>2)</sup> available only in STANDARD

<sup>3)</sup> the stop prevents application of a drop-down gasket and vice versa

<sup>4)</sup> special AntiFinger coating **NEW** to reduce dirt and fingerprints



# MENTON

REBATED, NON-REBATED AND REVERSE INTERIOR DOORS



MENTON 1, GREY GREKO OAK laminate, black matt TOPAZ



MENTON 1



MENTON 2



MENTON 3



MENTON 4



MENTON 5



MENTON 6



MENTON 7



MENTON 8



MENTON 9



MENTON 10



MENTON 11



MENTON 12

## CONSTRUCTION

- rebated, non-rebated or reverse door leaf
- MDF stiles and rails covered with two HDF boards in GREKO and FINISH laminates
- internal timber stile (sides and top, bottom -MDF) covered with two HDF boards in CPL and PREMIUM laminate
- honeycomb stabilising filling or solid core filling against an additional charge
- optionally, against an additional charge, upper panels extending the frame - page 134

**NEW**

## FINISHING

- door leaf edge made in the SOFT or STANDARD technology.
- CPL 0.2 & 0.7 laminates available only with the STANDARD edge with the ABS edging in the same colour as the door leaf only or, against an additional charge, with a standard black edge
- reverse door leaf only in the STANDARD edge and in GREKO, PREMIUM and ST CPL decors
- edge (in STANDARD or non-rebated finish) laminated in edging in the same colour as the surface or, optionally, in plain black (black edging with transverse larch decor and a black edge with a transverse structure)

## HARDWARE

- two pin mortise hinges or three hinges (GREKO & PREMIUM decors) in a rebated door leaf.
- three concealed hinges in the non-adjacent leaf and two hinges in the reverse leaf in silver (black against an extra charge); hinges are supplied and priced with the door frame

**NEW**

- bolt lock in the rebated leaf and magnetic lock in the non-rebated leaf and reverse leaf: with a key, thumb turn, economy or with silver, with a blockade; optionally, against an extra charge, a black magnetic lock

**NEW**

## GLAZING

- frosted decormat glass as standard, transparent or, charged extra, frosted VSG 221 safety glass, plain on both sides
- possibility to change the glazing side to REVERSE (OBVERSE - standard glazing)

## ADDITIONAL CHARGES

reverse door leaf **NEW**

(Not available in CPL 0.2 & 0.7)

solid core filling (price includes a third hinge used in the rebated door leaf as standard)

door closer reinforcement

arm door closer (silver, black, white, brown)

additional bottom bar (can be cut by customer up to max 8 cm)

ventilation door cut or grille

metal round or square ventilation sleeves (4 pcs);  
brushed nickel or patina finish in white or black

plastic sleeves

"100" rebated and non-rebated door leaf (price includes a third hinge used in the door leaf as standard)

frosted VSG 221 laminated glass

additional hinge in the rebated door leaf and used always as per Czech standard (not applicable to solid core leaf, GREKO & PREMIUM decors and "100" leaf)

drop-down gasket <sup>3)</sup>

metal hinge casings in the rebated door leaf (brushed nickel, patina, polished chrome, polished brass, white and black)

black door leaf edge finish **NEW**

can be replaced with a black magnetic lock for non-rebated and reverse leaves

magnetic stop (buffer) <sup>3)</sup> **NEW**  
(available in six colours p. 132)

### FINISH



### GREKO

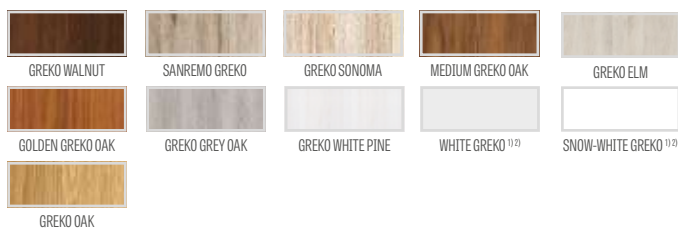

### CPL

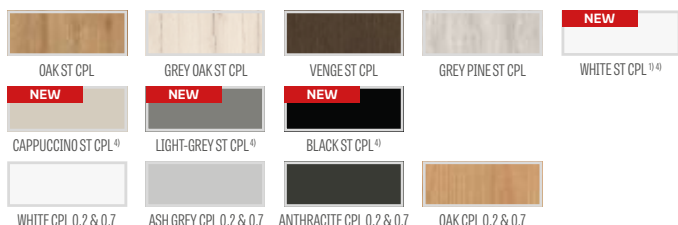

### PREMIUM

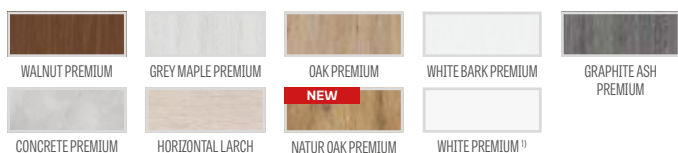

### AVAILABLE DOOR LEAF WIDTHS

60 70 80 90 100

### GLASS FRAME



### AVAILABLE SOLUTIONS (pp. 135-143)

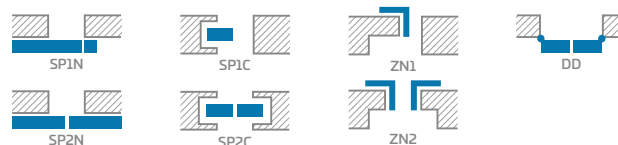

### EDGE FINISH TYPES

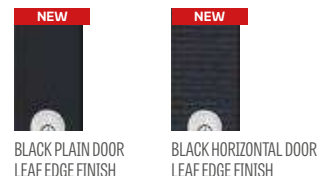

<sup>1)</sup> plain white laminate imitating a painted surface

<sup>2)</sup> available only in STANDARD

<sup>3)</sup> the stop prevents application of a drop-down gasket and vice versa

<sup>4)</sup> special AntiFinger coating **NEW** to reduce dirt and fingerprints



# SORANO

REBATED, NON-REBATED AND REVERSE INTERIOR DOORS



SORANO 1, WENGE ST CPL laminate, TOPAZ INOX handle



SORANO 1



SORANO 2



SORANO 3



SORANO 4



SORANO 5



SORANO 6



SORANO 7



SORANO 8



SORANO 9



SORANO 10



SORANO 11



SORANO 12



## CONSTRUCTION

- rebated, non-rebated or reverse door leaf
- MDF stiles and rails covered with two HDF boards in GREKO and FINISH laminates
- internal timber stile (sides and top, bottom -MDF) covered with two HDF boards in the CPL & PREMIUM laminate
- honeycomb stabilising filling or solid core filling against an additional charge
- optionally, against an additional charge, upper panels extending the frame - page 134

**NEW**

## FINISHING

- door leaf edge made in the SOFT or STANDARD technology.
- CPL 0.2 & 0.7 laminates available only with the STANDARD edge with the ABS edging in the same colour as the door leaf only or, against an additional charge, with a standard black edge
- reverse door leaf only in the STANDARD edge and in GREKO, PREMIUM and ST CPL decors
- edge (in STANDARD or non-rebated finish) laminated in edging in the same colour as the surface or, optionally, in plain black (black edging with transverse larch decor and a black edge with a transverse structure)

## HARDWARE

- two pin mortise hinges or three hinges (GREKO & PREMIUM decors) in a rebated door leaf
- three concealed hinges in the non-adjacent leaf and two hinges in the reverse leaf in silver (black against an extra charge); hinges are supplied and priced with the door frame

**NEW**

- bolt lock in the rebated leaf and magnetic lock in the non-rebated leaf and reverse leaf: with a key, thumb turn, economy or with silver, with a blockade; optionally, against an extra charge, a black magnetic lock

**NEW**

## GLAZING

- frosted decormat glass as standard, transparent or, charged extra, frosted VSG 221 safety glass, plain on both sides
- possibility to change the glazing side to REVERSE (OBVERSE - standard glazing)

## ADDITIONAL CHARGES

### reverse door leaf **NEW**

(not available in CPL 0.2 & 0.7)

solid core filling (price includes a third hinge used in the rebated door leaf as standard)

door closer reinforcement

arm door closer (silver, black, white, brown)

additional bottom bar (can be cut by customer up to max 8 cm)

ventilation door cut or grille

metal round or square ventilation sleeves (4 pcs);  
brushed nickel or patina finish in white or black

plastic sleeves

"100" rebated and non-rebated door leaf (price includes a third hinge used in the door leaf as standard)

frosted VSG 221 laminated glass

additional hinge in the rebated door leaf and used always as per Czech standard (not applicable to solid core leaf, GREKO & PREMIUM decors and "100" leaf)

drop-down gasket <sup>3)</sup>

metal hinge casings in the rebated door leaf (brushed nickel, patina, polished chrome, polished brass, white and black)

black door leaf edge finish **NEW**

can be replaced with a black magnetic lock for non-rebated and reverse leaves

magnetic stop (buffer) <sup>3)</sup> **NEW**

(available in six colours p. 132)

### FINISH



WALNUT FINISH

LIGHT ACACIA FINISH

ACACIA FINISH

### GREKO

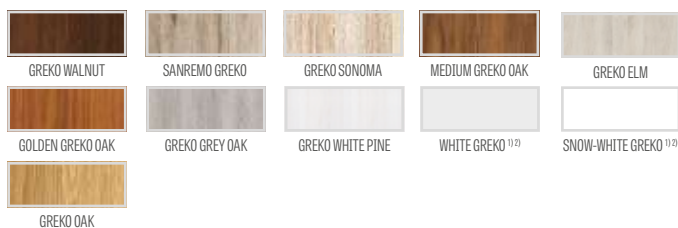

GREKO WALNUT

SANREMO GREKO

GREKO SONOMA

MEDIUM GREKO OAK

GREKO ELM

GOLDEN GREKO OAK

GREKO GREY OAK

GREKO WHITE PINE

WHITE GREKO <sup>1)</sup>

SNOW-WHITE GREKO <sup>1)</sup>

GREKO OAK

### CPL



OAK ST CPL

GREY OAK ST CPL

VENGE ST CPL

GREY PINE ST CPL

WHITE ST CPL <sup>1)</sup>

CAPPUCCINO ST CPL <sup>4)</sup>

LIGHT-GREY ST CPL <sup>4)</sup>

BLACK ST CPL <sup>4)</sup>

WHITE CPL 0.2 & 0.7

ASH GREY CPL 0.2 & 0.7

ANTHRACITE CPL 0.2 & 0.7

OAK CPL 0.2 & 0.7

### PREMIUM

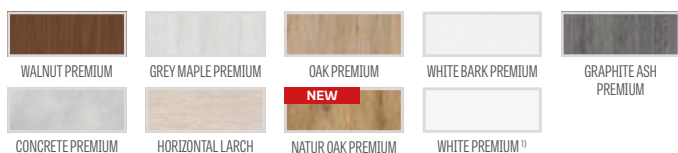

WALNUT PREMIUM

GREY MAPLE PREMIUM

OAK PREMIUM

WHITE BARK PREMIUM

GRAPHITE ASH PREMIUM

CONCRETE PREMIUM

HORIZONTAL LARCH

NATUR OAK PREMIUM

WHITE PREMIUM <sup>1)</sup>

## AVAILABLE DOOR LEAF WIDTHS

60 70 80 90 100

## GLASS FRAME

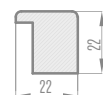

## AVAILABLE SOLUTIONS (pp. 135-143)

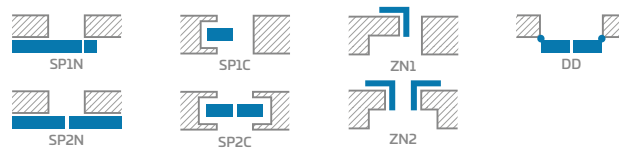

## EDGE FINISH TYPES

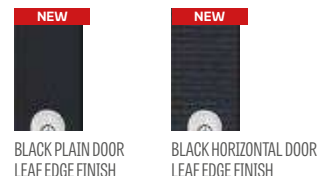
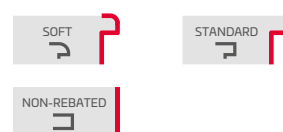

<sup>1)</sup> plain white laminate imitating a painted surface

<sup>2)</sup> available only in STANDARD

<sup>3)</sup> the stop prevents application of a drop-down gasket and vice versa

<sup>4)</sup> special AntiFinger coating **NEW** to reduce dirt and fingerprints



# FORTECA RC2 & RC3

OPENING INWARDS/OUTWARDS RC2 & RC3 BURGLARPROOF REBATED DOORS



FORTECA RC 3, laminate: GRAPHITE ASH PREMIUM



2 HOOK BOLTS



UPPER AND LOWER SECURITY LOCKS



FOUR DOOR STRIKER PLATES  
Adjustable

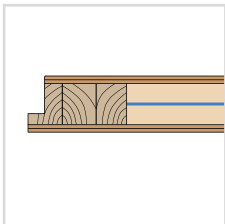

DOOR LEAF 46 mm  
Steel sheet reinforced



FORTECA RC2



FORTECA RC3



DOOR VIEWER



FOUR 2-PIN HINGES; Ø16, 3D ADJUSTABLE



4 HINGE BOLTS



FIXED DOOR FRAME  
Timber frame in RC2; Reinforced frame in RC3



HARDWOOD TRESHOLD (lacquer)



STAINLESS STEEL TRESHOLD



MULTIPOINT LOCK



### FORTECA DOOR LEAF CROSS-SECTION

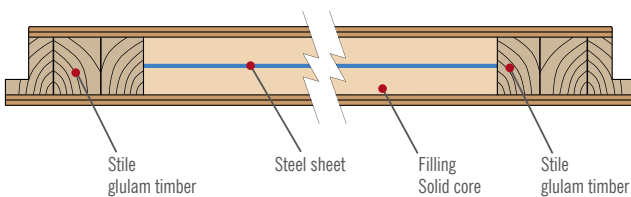

### HARDWOOD TRESHOLD

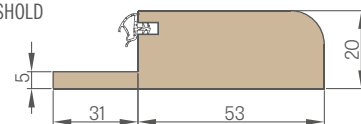

### STAINLESS STEEL SHEET TRESHOLD

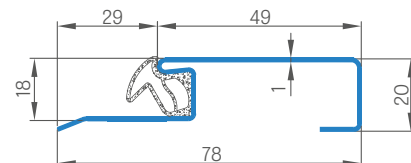



# FORTECA RC2 & RC3

OPENING INWARDS/OUTWARDS RC2 & RC3 BURGLARPROOF REBATED DOORS



Presented model: FORTECA RC2 & RC3 in OAK ST CPL laminate



FORTECA RC2, laminate NATUR OAK PREMIUM, handle black matt

FORTECA RC2 <span style="color: red;">NEW</span>		
GOLD PACKAGE	SILVER PACKAGE	DOOR LEAF

FORTECA RC3 <span style="color: red;">NEW</span>		
GOLD PACKAGE	SILVER PACKAGE	DOOR LEAF

**RC2 – Important:**  
 For compliance with RC2 burglary resistance class as per the PN-EN 1627:2012, the hardware should meet the following requirements:

- Min Class 2 as per PN-EN 1906:2012 – for handles and door face plates
- Min Class 4 and 1 as per PN-EN 1303:2015 – for lock cylinders

**RC3 – Important:**  
 For compliance with RC3 burglary resistance class as per PN-EN 1627:2012, the hardware should meet the following requirements:

- Min Class 3 as per PN-EN 1906:2012 – for handles and door face plates
- Min Class 4 and 1 as per PN-EN 1303:2015 – for lock cylinders

## GENERAL INFORMATION

- the FORTECA inwards/outwards opening burglar-proof doors are rated for sound insulation at  $R_w=38$  Db, have a burglary resistance class of RC2 OR RC3 as per PN EN 1627:2012 and class 5 for mechanical durability.
- available in the GOLD and SILVER packages with optional installation kit and steel door frame.
- designed to be used as an internal front door.

## CONSTRUCTION

- timber stile covered with glulam HDF boards
- specially designed solid core filling
- whole door leaf reinforced with a steel panel
- door leaf thickness of 46 mm

## FINISHING

- leaf edge made in the STANDARD technology (with CPL 0.2 & 0.7 laminates, with the ABS edging in the same colour as the leaf only or with a standard black edge against an additional charge)
- 8 mm or 220 mm wide black brushed steel or OAK CPL inserts (inlays) flush with the door leaf, on both sides of the leaf **NEW**
- the edge laminated in the same colour as the door leaf or, optionally plain black (transverse larch, black edge with a transverse structure) **NEW**
- HDF board covered with the FINISH, GREKO or PREMIUM laminate
- side and top panels glued to the wall (only with a masonry wall installed door frame and an 8 cm clip-on square) made to order for additional charge - page 134 **NEW**

## HARDWARE

- four silver 2-pin hinges;  $\varnothing 16$ ; 3D adjustable (2D with steel frame)
- four-point security hook bolt lock as standard for two lock cores
- four-hinge bolts on the hinge side
- possibility to apply an arm door closer
- lower lock PZ centre is 92 mm

## FIXED REBATED DOOR FRAME

- fixed timber door frame covered with MDF boards; Internally reinforced with a steel square on the door striker plates side for FORTECA RC3
- installation in the range of 90-450 mm every 40 mm
- adjustable main grip in the door frame and two adjustable grips for the bolt hook and additional lock

## GOLD PACKAGE

- the GOLD PACKAGE FORTECA doors are complete with a steel or timber threshold, with a multipoint lock, and pre-drilled holes for a security handle and upper face plate. They come with a door viewer (hole to be drilled by the customer) and certified security handles and lock cores.

## SILVER PACKAGE **NEW**

- the SILVER PACKAGE FORTECA doors are complete with a steel or timber threshold, and a multipoint lock. We recommend ordering a door viewer and certified hardware from the ERKADO range or ordering the same from an external supplier keeping in mind the important note on compliance with the anti-burglary requirements (p. 100).

## ADDITIONAL CHARGES

"100" door

black door leaf edge finish

handle PZ centre of 92 mm with the top face plate for RC 2 doors, silver F9 or black (Class 2 as per the PN-EN 1906:2012 standard)

handle with lock core protection and the rosette plate for the RC3 door; F9 silver (Class 3 as per PN-EN 1906:2012)

two silver lock cores set (one with a thumbturn) in a master key system for RC2 and RC3 doors (Class 4 & 1 as per PN-EN 1303:2015)

door viewer (nickel or black)

metal hinge covers (satin nickel, patina)

cutting the door with the wooden frame to 8 cm and with steel frame to 1 cm

LUX inlay; available versions p. 80-81

arm door closer (silver, black, white, brown)

magnetic stop (buffer) **NEW**  
(available in six colours p. 132)

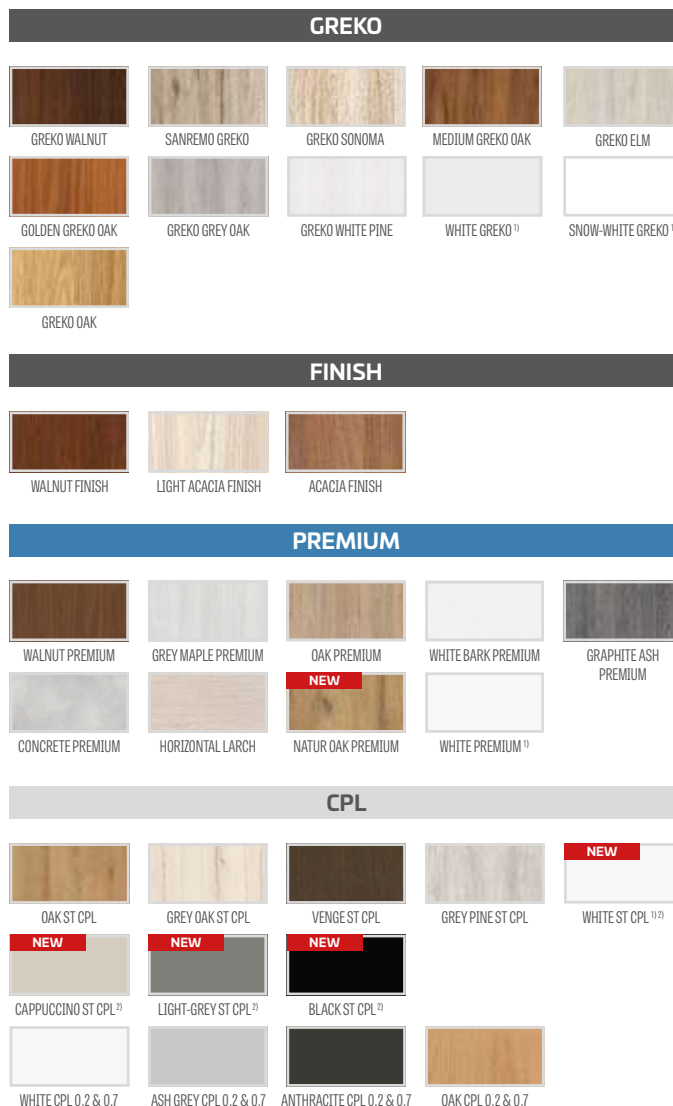

<sup>1)</sup> plain white laminate imitating a painted surface

<sup>2)</sup> special AntiFinger coating to reduce dirt and fingerprints



# FIXED DOOR FRAME

FORTECA

## FORTECA RC3 FIXED DOOR FRAME

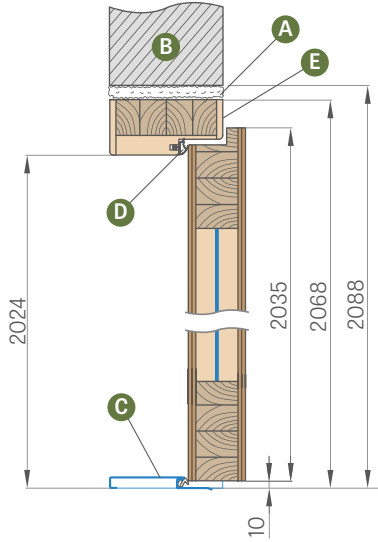

- A - installation foam
- B - wall
- C - stainless steel or wooden threshold
- D - rubber gasket
- E - additional internal reinforcement in the frame with a steel square on the door striker plates side (only for the Fortress RC3 door frame)

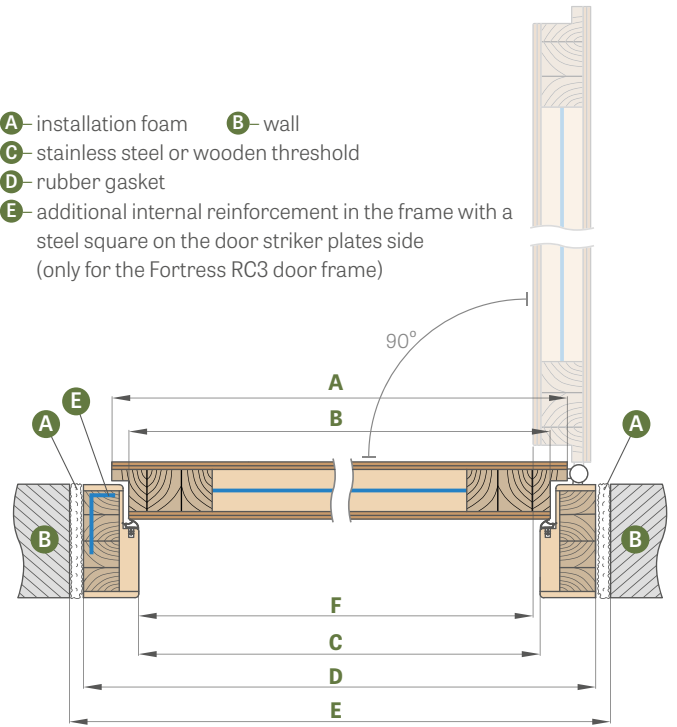

**MASONRY WALL every 40 mm**  
(the clip-on square not included, charged extra)

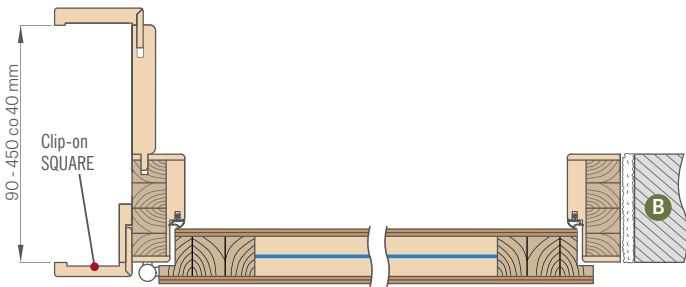

Range (mm)
90-130
130-170
170-210
210-250
250-290
290-330
330-370
370-410
410-450

Door Width	A	B	C	D	E	F
"80N"	804	778	764	852	892	759
"80"	848	822	808	896	936	803
"90"	948	922	908	996	1036	903
"100"	1048	1022	1008	1096	1136	1003

The wall cladding is available with a 6 cm or 8 cm internal angle and with a choice of 6 cm or 8 cm external angle against an extra charge.

### ADDITIONAL CHARGES

frame joints at 90 degrees

clip-on square with 60 mm or 80 mm clips **NEW**  
(the clip-on square with three clips extends the adjustment range by 20 mm)

cutting the door with the wooden frame to 8 cm in 1 cm increments

side and top panels glued to the wall available (only with a wall installed door frame and an 8 cm square) **NEW**

headband and quarter round

### FIXED DOOR FRAME

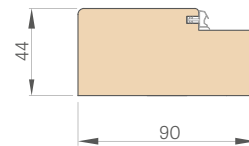

### MASKING STRIP

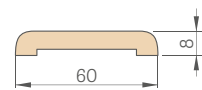

### Clip-on SQUARE 6 cm and 8 cm with clips **NEW**

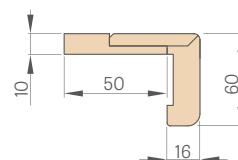
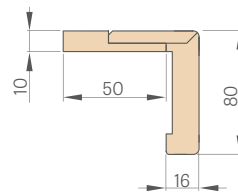

### QUARTER ROUND

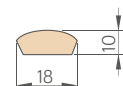



# STEEL DOOR FRAMES

FORTECA

NEW

## ADJUSTABLE STEEL DOOR FRAME (OVERLAPPING)

Welded and coated in RAL 9003, 9010, 9016, 8003, 8017, 7016, 7022, 7047, 1001

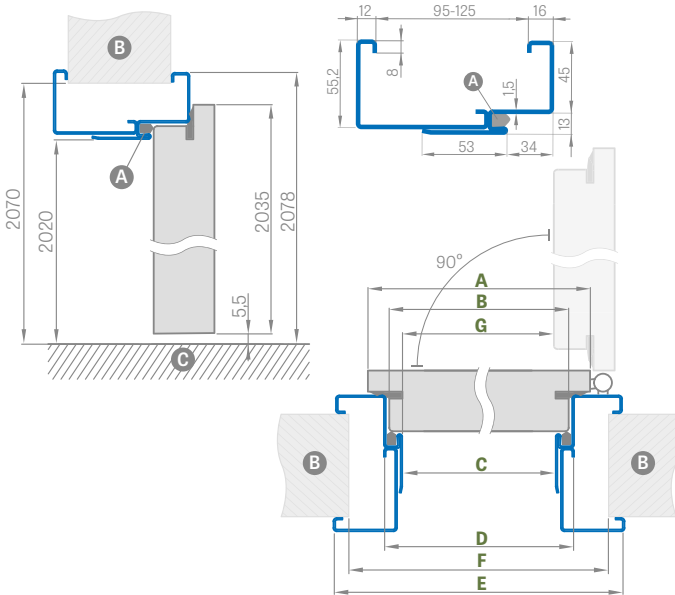

Door width	A	B	C	D	E	F	G
"80N"	804	778	761	787	877	865	754.5
"80"	848	822	805	831	921	910	798.5
„90E"	960	934	917	943	1033	1022	910
"100" 1)	1048	1022	1005	1031	1121	1110	998.5

„90E" - investment width

FORTECA RC2 ADJUSTABLE STEEL DOOR FRAME	
Adjustment Range min-max (mm)	
95-125	
125-155	
155-185	
185-215	
215-245	
245-275	
275-305	
305-335	
335-365	

FORTECA RC3 ADJUSTABLE STEEL DOOR FRAME	
Adjustment Range min-max (mm)	
95-125	
125-155	
155-185	
185-215	
215-245	
245-275	
275-305	
305-335	
335-365	

## SQUARE STEEL DOOR FRAME, LARGE VERSION

Welded and coated in RAL 9003, 9010, 9016, 8003, 8017, 7016, 7022, 7047, 1001

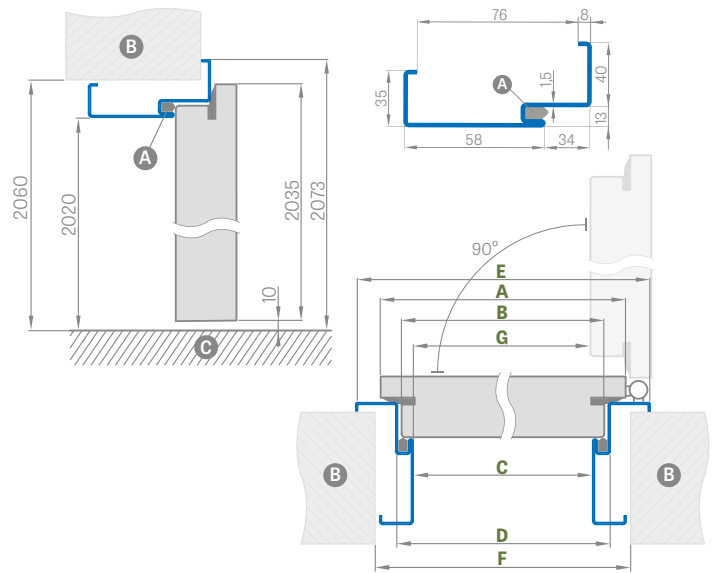

Door width	A	B	C	D	E	F	G
"80N"	804	778	761	787	867	840	754.5
"80"	848	822	805	831	911	885	798.5
„90E"	960	934	917	943	1023	997	910
"100" 1)	1048	1022	1005	1031	1111	1085	998.5

## FITTING THE SQUARE FRAME

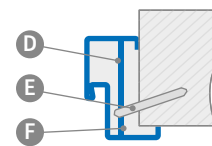

- A - gasket
- B - Wall
- C - Floor
- D - mounting anchor
- E - anchor bolt
- F - To be filled

## ADDITIONAL CHARGES

"100" Square frame, large version

door closer reinforcement

stainless steel threshold

cutting the door with the steel frame to 6 cm in 1 cm increments

galvanised sheet steel

non-typical RAL (intensive, pearly and metallic colours not included)

## RAL



<sup>1)</sup> additional charge +10%



# HERSE SET 32dB

HERSE SET AKUSTIC 39 dB

FRONT DOORS WITH BURGLAR-PROOF LOCKS OR STRIP LOCKS



Presented model: HERSE LUX SET 4 in WALNUT GREKO finish with an ESSEN handle





UPPER SECURITY LOCK



LOWER SECURITY LOCK



ADJUSTABLE MAIN KEEPER IN FRAME



ESSEN HANDLE



NEW

LEAF 46 mm  
HERSE SET AKUSTIC 39 dB  
reinforced with sheet steel



46 mm HERSE SET 32 dB door leaf  
with channel reinforced



SOUND INSULATION  
32 dB/39 dB



THREE 2-PIN HINGES; Ø16, 3D ADJUSTABLE



3 HINGE BOLTS



FIXED WOODEN DOOR FRAME



HARDWOOD TRESHOLD (lacquer)



DOOR VIEWER



DROP-DOWN gasket with  
pressure adjustment



STAINLESS STEEL TRESHOLD

### HERSE DOOR LEAF CROSS-SECTION



additional gasket  
in the door leaf

SOFT or STANDARD  
Technology

Timber stile

Solid panel

Steel channel section  
reinforced (thickness 2 mm)

HARDWOOD TRESHOLD

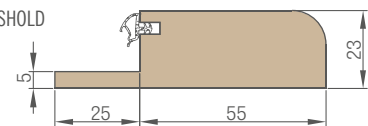

STAINLESS STEEL SHEET TRESHOLD

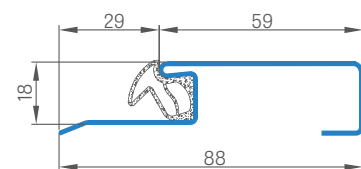



# HERSE SET 32dB

HERSE SET AKUSTIC 39 dB

NEW

FRONT DOORS WITH BURGLAR-PROOF LOCKS OR STRIP LOCKS



Presented model: HERSE SET in GREKO WALNUT finish with ESSEN handle

GOLD PACKAGE

SILVER PACKAGE

DOOR LEAF

## GENERAL INFORMATION

- HERSE SET Doors are designed for housing and public utility building as an entrance internal door (excluding the "80N" width).
- the HERSE SET leaf with fixed and adjustable door frame with each of threshold available is rated for sound insulation at  $R_w = 32\text{dB}$
- HERSE SET Doors in GOLD and SILVER Packages are fully preassembled with a threshold fitted, and pre-drilled holes for handle and face plate installation for the GOLD version.

## CONSTRUCTION

- timber and MDF stile covered with two HDF boards
- specially designed solid core filling
- robust steel channel section reinforced
- door leaf thickness of 46 mm
- additional gasket in the door leaf

## FINISHING

- door leaf edge made in the SOFT or STANDARD technology
- CPL 0.2 & 0.7 laminates available only with the STANDARD edge with the ABS edging in the same colour as the door leaf only or, against an additional charge, with a standard black edge
- 8 mm or 200 mm wide brushed steel, black or OAK CPL inlays flush with the door leaf, on both leaf sides
- the STANDARD edge laminated in the same colour as the door leaf or, optionally, plain black edging (transverse larch, black edge with a transverse structure) **NEW**
- pre-cut up to 8 cm as an option
- custom order with the lower lock only as an option
- side and top panels glued to the wall (only with the adjustable door frame and an 8 cm square) - page 134 **NEW**

## HARDWARE

- three silver 2-pin hinges;  $\varnothing 16$ ; 3D adjustable (2D with a steel frame)
- two 3-pin Class 2 rated security locks with a thumb turn (optionally only lower)
- three hinge bolts on the hinge side
- possibility to apply an arm door closer
- lower lock PZ centre is 72 mm
- optionally, a bolt strip lock with two cores, against an extra charge

## REBATED FIXED AND ADJUSTABLE DOOR FRAMES

- optionally, an electric door strike can be used in the door frame for the lower lock with no upper lock in the door leaf.
- adjustable main keeper in frames
- the 80N **NEW** width is available on the fixed door frame only

## AVAILABLE DOOR LEAF WIDTHS

80 80N 90 100

## EDGE FINISH TYPES



GOLD PACKAGE Door leaf with fixed timber door frame, stainless steel threshold and hardware <sup>4)</sup>

SILVER PACKAGE Door leaf with fixed timber door frame, stainless steel threshold, w/o hardware <sup>4)</sup>

<sup>4)</sup> Hardware includes ESSEN handle in nickel satin, upper face plate, lock cores with 1 key system (upper one with a thumb turn), door viewer (not pre-drilled)

## ADDITIONAL CHARGES

door viewer

hardwood threshold (lacquer) for adjustable frames 55 mm or stainless steel threshold with gasket

hardwood threshold (lacquer) for adjustable frames

arm door closer (silver, black, white, brown)

door closer reinforcement

drop-down gasket <sup>2)</sup>

cutting the door leaf with a wooden frame up to 8 cm every and up to 6 cm with a steel frame in the CZ standard

black door leaf edge finish

"100" Door leaf or package

30/45 lock core

30G/45 or 30/45G cylinder-holder

30/45 lock core and 30G/45 or 30/45G cylinder-holder in the master key system

metal covers of the hinge (satin nickel, patina, black)

ESSEN handle (nickel, satin, patina, black)

ESSEN upper face plate (nickel, satin, patina, black)

LUX inlay; available versions p. 80-81

additional charge for HERSE SET AKUSTIC 39 dB door (added to the GOLD and SILVER packages or leaves)

clip-on square, 3 pcs (The clip-on square extends the adjustment range by 20 mm)

magnetic stop (buffer) <sup>2)</sup> **NEW**  
(available in six colours p. 132)

multi-point bolt strip lock with two locks

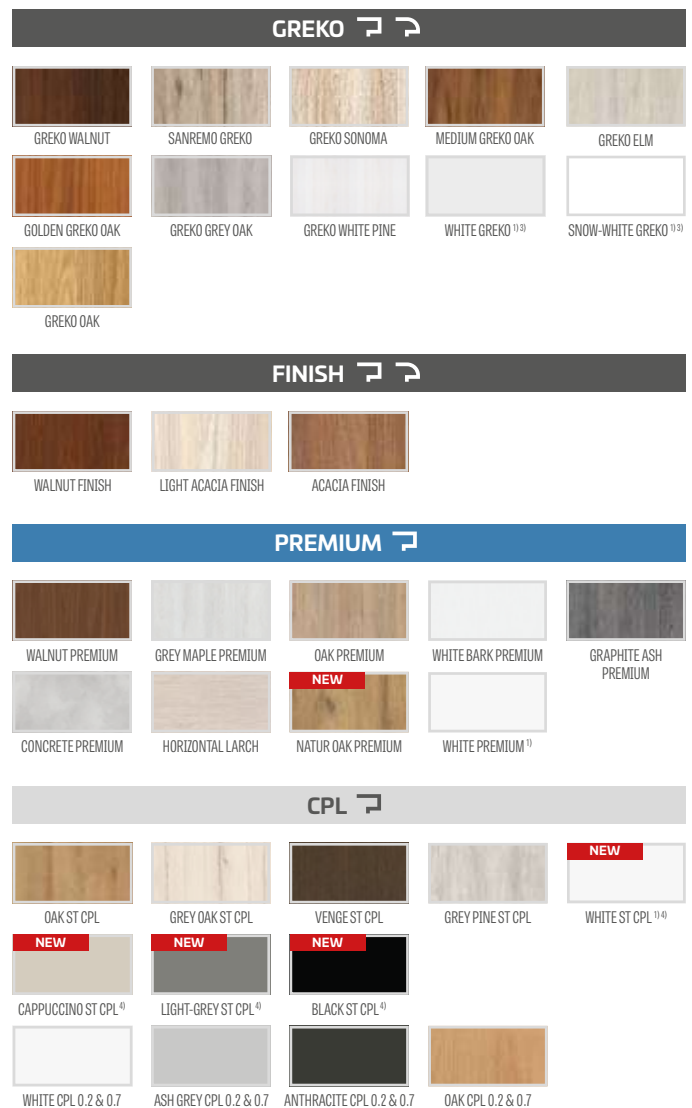

<sup>1)</sup> plain white laminate imitating a painted surface

<sup>2)</sup> the stop prevents application of a drop-down gasket and vice versa

<sup>3)</sup> available only in STANDARD

<sup>4)</sup> special AntiFinger coating to reduce dirt and fingerprints



HERSE SET, laminate OAK PREMIUM, ESSEN handle



# HERSE MAX SET 32dB

HERSE MAX SET AKUSTIC 39 dB

NEW

FRONT DOORS WITH BURGLAR-PROOF LOCKS OR STRIP LOCKS



Presented model: HERSE MAX SET 23 in OAK PREMIUM finish with ESSEN handle

## GENERAL INFORMATION

- HERSE MAX SET Doors are designed for housing and public utility building as an entrance internal door (excluding the "80N" width).
- The HERSE MAX SET leaf with fixed and adjustable door frame with each of threshold available is rated for sound insulation at  $R_w = 32\text{dB}$  or, against an additional charge,  $R_w = 39\text{dB}$
- HERSE MAX SET Doors in GOLD and SILVER Packages are complete with a threshold, and have pre-drilled holes for handle and face plate installation for the GOLD version.

## CONSTRUCTION

- timber and MDF stile covered with two HDF boards
- specially designed solid core filling
- robust steel channel section reinforced
- door leaf thickness of 46 mm
- additional gasket in the door leaf

## FINISHING

- the STANDARD edge laminated in the same colour as the door leaf or, optionally, plain black edging (transverse larch, black edge with a transverse structure)
- moulded HDF board covered with PREMIUM laminate
- pre-cut up to 8 cm as an option
- side and top panels glued to the wall (only with the adjustable door frame and an 8 cm square) - page 134 **NEW**

## HARDWARE

- three silver 2-pin hinges;  $\varnothing 16$ ; 3D adjustable
- two 3-pin Class 2 rated security locks with a thumb turn (optionally only lower)
- three hinge bolts on the hinge side
- possibility to apply an arm door closer
- lower lock PZ centre is 72 mm
- optionally, a bolt strip lock with two cores, against an extra charge

## REBATED FIXED AND ADJUSTABLE DOOR FRAMES

- optionally, an electric door strike can be used in the door frame for the lower lock with no upper lock in the door leaf.
- adjustable main keeper in frames
- The 80N **NEW** width is available on the fixed door frame only

GOLD PACKAGE	SILVER PACKAGE	DOOR LEAF
--------------	----------------	-----------

## PREMIUM

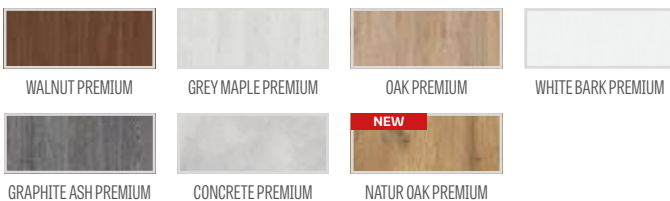

## MOULDING

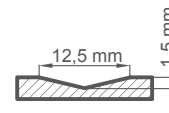

## AVAILABLE DOOR LEAF WIDTHS

80	80N	90	100
----	-----	----	-----

## EDGE FINISH TYPES

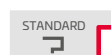

- GOLD PACKAGE** Door leaf with fixed timber door frame, stainless steel threshold and hardware <sup>4)</sup>
- SILVER PACKAGE** Door leaf with fixed timber door frame, stainless steel threshold, w/o hardware <sup>4)</sup>

<sup>4)</sup> Hardware includes ESSEN handle in nickel satin, upper face plate, lock cores with 1 key system (upper one with a thumb turn), door viewer (not pre-drilled)

## ADDITIONAL CHARGES

door viewer
black door leaf edge finish
hardwood threshold (lacquer) for adjustable frames 55 mm or stainless steel threshold with gasket
hardwood threshold (lacquer) for adjustable frames
arm door closer (silver, black, white, brown)
door closer reinforcement
drop-down gasket <sup>1)</sup>
cutting the door leaf with a wooden frame up to 8 cm every and up to 6 cm with a steel frame in the CZ standard
"100" door leaf or package
30/45 lock core
30G/45 or 30/45G cylinder-holder

30/45 lock core and 30G/45 or 30/45G cylinder-holder in the master key system
metal covers of the hinge (satin nickel, patina, black)
ESSEN handle (nickel, satin, patina, black)
ESSEN upper face plate (nickel, satin, patina, black)
additional charge for the door HERSE MAX SET AKUSTIC39 dB (added to GOLD and SILVER packages or wing)
clip-on square, 3 pcs (The clip-on square extends the adjustment range by 20 mm)
magnetic stop (buffer) <sup>1)</sup> <b>NEW</b> (available in six colours p. 132)
multi-point bolt strip lock with two locks



HERSE MAX SET 24



HERSE MAX SET 25



HERSE MAX SET 26



HERSE MAX SET 27



HERSE MAX SET 28



HERSE MAX SET 29



HERSE MAX SET 30



HERSE MAX SET 31

<sup>1)</sup> the stop prevents application of a drop-down gasket and vice versa



# FIXED AND ADJUSTABLE FRAMES

HERSE SET, HERSE MAX SET

## HERSE SET FIXED DOOR FRAME

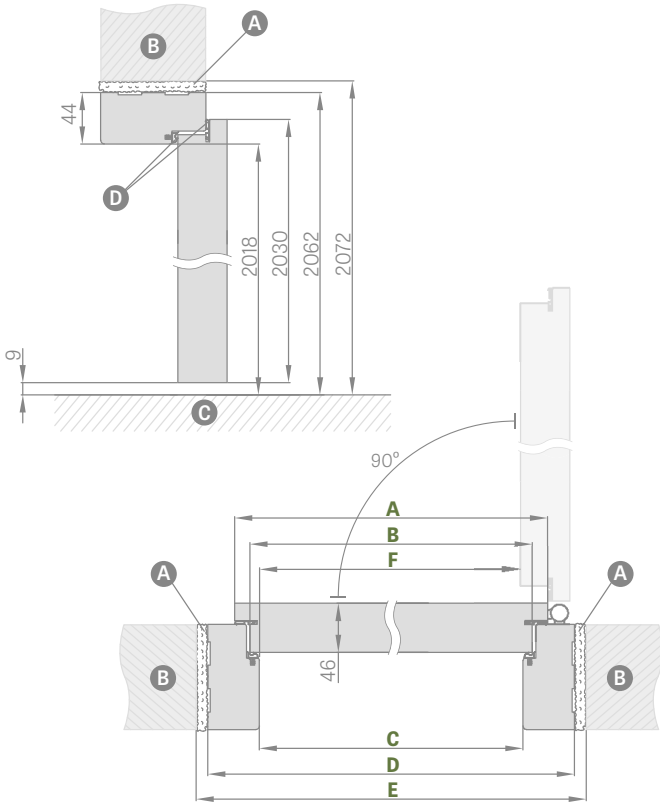

Door width	A	B	C	D	E	F
"80N"	804	777	764	852	872	756
"80"	844	817	804	892	912	796
„90E"	948	921	908	996	1016	900
"100"	1044	1017	1004	1092	1112	996

„90E" - investment width

## HERSE SET ADJUSTABLE DOOR FRAME

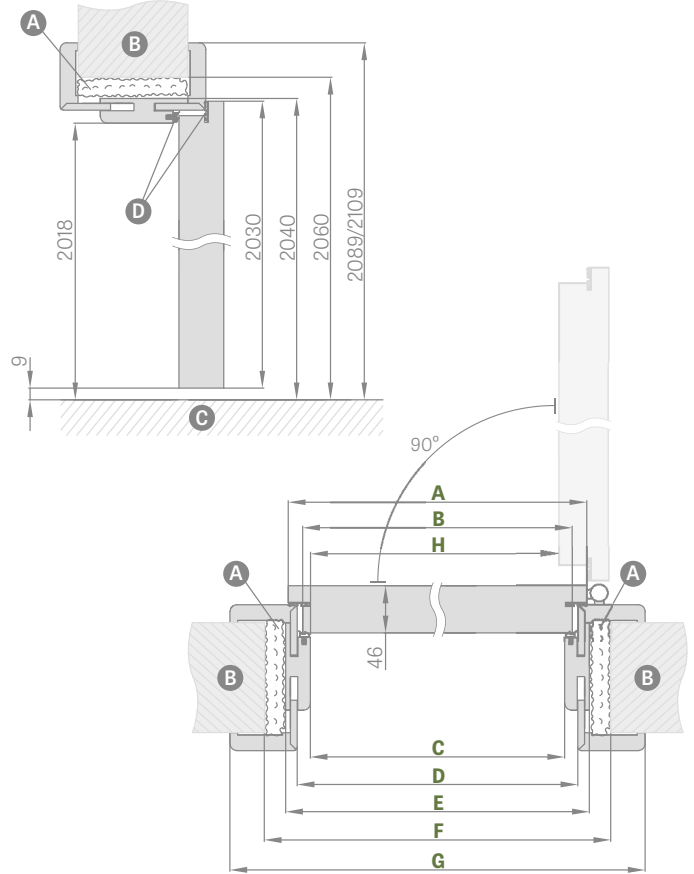

Door width	A	B	C	D	E	F	G	H
"80"	844	817	804	826	848	888	946*/986**	796
„90E"	948	921	908	930	952	992	1050*/1090**	900
"100"	1044	1017	1004	1026	1048	1088	1146*/1186**	996

\*strip 6 cm / \*\*strip 8 cm

- A** - installation foam
- B** - wall
- C** - floor
- D** - rubber gasket

## ADJUSTABLE DOOR FRAME RANGE

strip 6 cm / strip 8 cm

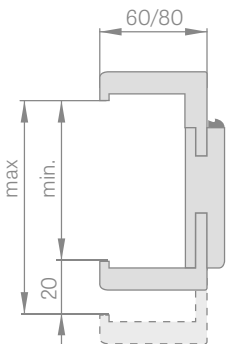

## ADJUSTABLE TIMBER THRESHOLD

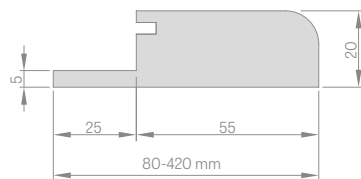

**NEW**  
SQUARE: 6 cm and 8 cm

Clip-on

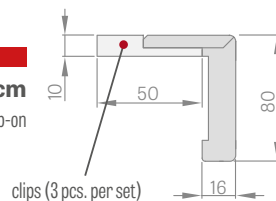

## FIXED DOOR FRAME

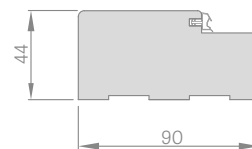

## MASKING STRIP

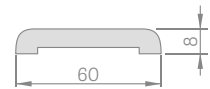

## QUARTER ROUND

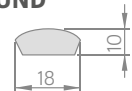

## FIXED AND ADJUSTABLE DOOR FRAMES

	Adjustment range min-max (mm)
1 Component	80-100
	100-120
	120-140
	140-160
	160-180
	180-200
	200-220
2 Components	220-240
	240-260
	260-280
	260-300
	280-300
	300-320
3 Components	320-340
	340-360
	360-380
	380-400
	400-420

## FIXED HARDWOOD TRESHOLD, COLOURLESS LACQUER 55mm



- The fixed frame, architrave and clip-on square in CPL 0.2 are also used in the set for door leaves in CPL 0.7
- Joints at 90 degrees of the adjustable frame possible with the 8 cm architraves only.
- Electric door strike
- Door closer reinforcement for adjustable door frame –
- Square with three clips **NEW** (square with clips extends the adjustment range by 20 mm)
- Strip and quarter round
- Side and top panels glued to the wall available (only with an adjustable door frame and an 8 cm strip) **NEW**
- Cutting the door (leaf and frame) up to 8 cm every 1 cm or the product as per the CZ standard



# STEEL DOOR FRAMES

HERSE SET, HERSE MAX SET

## HERSE SET ADJUSTABLE STEEL DOOR FRAME (OVERLAPPING)

Welded and coated in RAL 9010, 9016, 8003, 8017, 7016, 7047, 1001

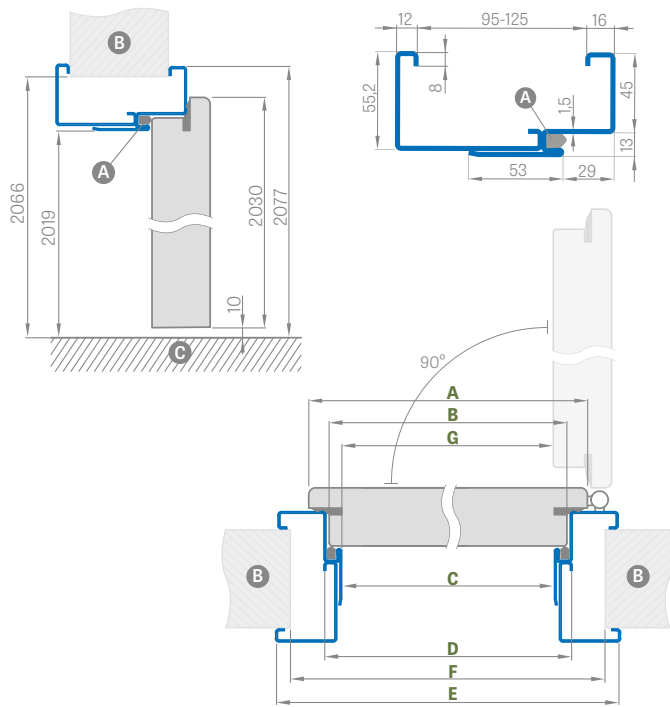

Door width	A	B	C	D	E	F	G
"80N"	804	777	761	787	877	855	756
"80"	844	817	801	827	917	895	796
„90E"	948	921	905	931	1021	999	900
"100"	1044	1017	1001	1027	1117	1095	996

„90E" - investment width

Adjustment Range min-max (mm)
95-125
125-155
155-185
185-215
215-245
245-275
275-305

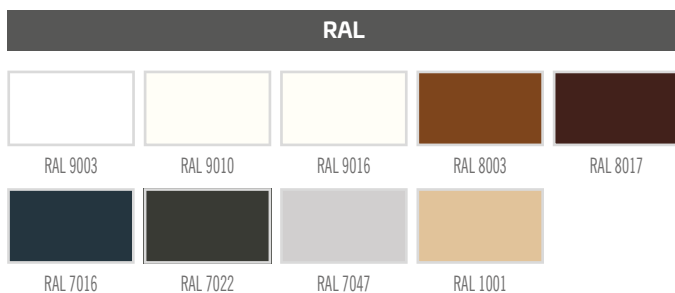

## HERSE SET ADJUSTABLE STEEL DOOR FRAME (OVERLAPPING)

Welded and coated in RAL 9003, 9010, 9016, 8003, 8017, 7016, 7022, 7047, 1001

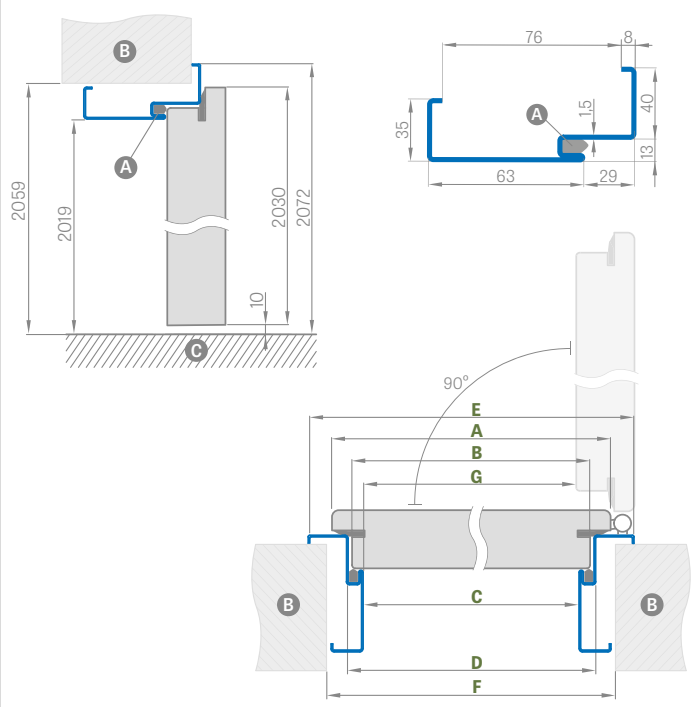

Door width	A	B	C	D	E	F	G
"80N"	804	777	761	787	867	841	756
"80"	844	817	801	827	907	881	796
„90E"	948	921	905	931	1011	985	900
"100"	1044	1017	1001	1027	1107	1081	996

## FITTING THE SQUARE FRAME

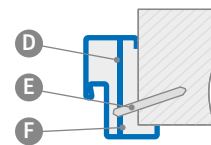

- A - gasket
- B - wall
- C - floor
- D - mounting anchor
- E - anchor bolt
- F - To be filled

## ADDITIONAL CHARGES

"100" Square frame, large version

electric door strike

door closer reinforcement

cutting the door with the steel frame to 6 cm in 1 cm increments

stainless steel threshold

galvanised sheet steel

non-typical RAL (intensive, pearly and metallic colours not included)





# UNITED STEEL DOOR FRAME

HERSE SET, HERSE MAX SET

## UNITED STEEL DOOR FRAME DIAGRAM

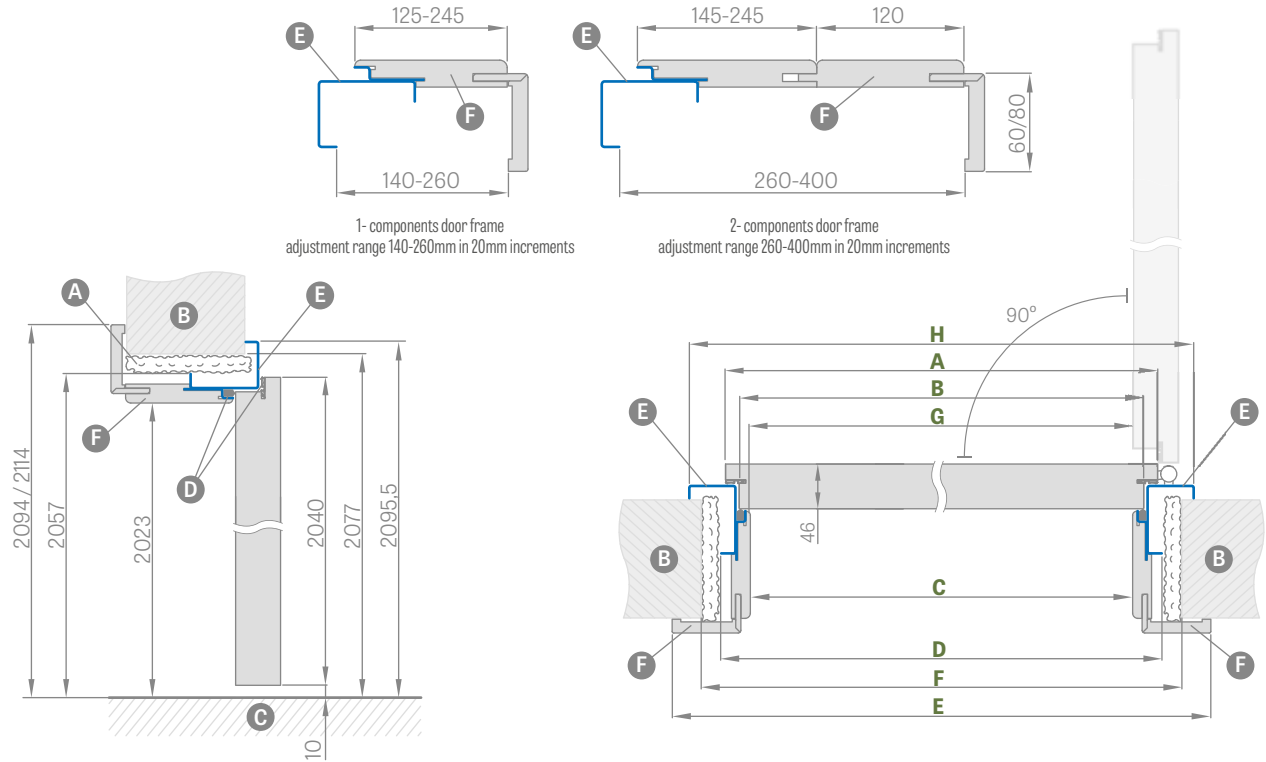

Door width	A	B	C	D	E	F	G	H
"80"	844	817	791.5	859	933.5/973.5	899	790	935
„90E"	960	933	907.5	975	1049.5/1089.5	1015	906	1051
"100"	1044	1017	991.5	1059	1133.5/1173.5	1099	990	1135

„90E" - investment width

- A** - installation foam
- B** - wall
- C** - floor
- D** - rubber gasket
- E** - steel part painted in RAL colour
- F** - part MDF laminate

### ADDITIONAL CHARGES

- electric door strike
- door closer reinforcement
- shortening of a leaf with a UNITED steel door frame up to 6 cm in 1 cm increments
- stainless steel threshold, height: 20 mm
- galvanised sheet steel
- non-typical RAL (intensive, pearly and metallic colours not included)

Adjustment range min-max (mm)	
1 component	140-160
	160-180
	180-200
	200-220
	220-240
	240-260
2 Components	260-280
	280-300
	300-320
	320-340
	340-360
	360-380
	380-400

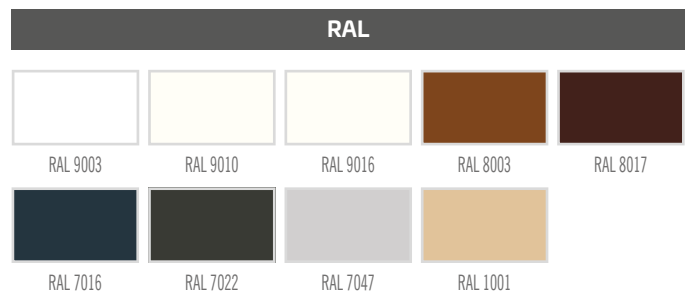



# LEDA EI30, EI60

FIRE INTERNAL FRONT DOORS MADE IN HALSPAN TECHNOLOGY



## ADJUSTABLE STEEL DOOR FRAME (OVERLAPPING)

Adjustment Range min-max (mm)
95-125
125-155
155-185
185-215
215-245
245-275
275-305

### GREKO

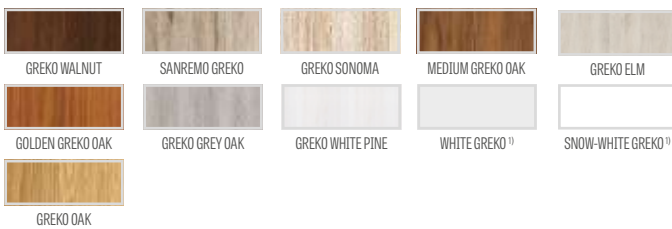

### FINISH



### CPL

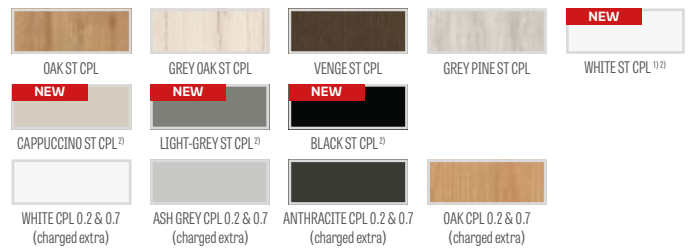

### PREMIUM

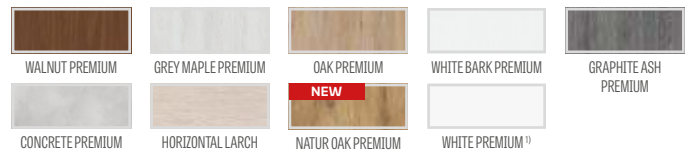

<sup>1)</sup> plain white laminate imitating a painted surface

<sup>2)</sup> special AntiFinger coating to reduce dirt and fingerprints

## GENERAL INFORMATION

Fire protection, smoke control and sound insulation are ensured only when a complete doorset is installed, including a fire door leaf (with gaskets, lock, hinges and drop-down gasket pre-assembled), door frame, door closer, as well as a lock core and handle in compliance with the Polish Standard.

The sound insulation of the HALSPAN door system supplied with a drop-down gasket as per PN-B-02151-03:1999 is rated at  $R_w=32$  dB

The door leaves are marketed complete with a timber or steel door frame only.

## CONSTRUCTION

- filled with a special HALSPAN board with a thickness of 44 mm for Type EI30 and 54 mm for EI60
- overall door leaf thickness 50 mm in EI30 and 60 mm in EI60
- softwood door frame
- fire rated and smoke intumescent door gasket
- drop-down gasket
- transparent fire-resistant glass; the glass width is fixed (not dependent on) the door leaf width

## FINISHING

- leaf edge made in the STANDARD technology (with CPL 0.2 & 0.7 laminates, laminated with the ABS edging in the same colour as the leaf only) or with a standard black edge against an additional charge
- 8 mm or 200 mm wide brushed steel, black or OAK CPL inlays flush with the door leaf, on both leaf sides Applies to LEDA full only. **NEW**  
Inlay types shown on pages 80-81
- two-sided inlays only in full leaf and on only on the active leaf in double-leaf doors
- the edge laminated in the same colour as the door leaf or, optionally plain black (transverse larch, black edge with a transverse structure) **NEW**
- side and top panels glued to the wall (only when fitted with an 8 cm square) - page 134 **NEW**

## HARDWARE

- four hinges;  $\varnothing 16$ ; 3D adjustable (2D for the steel frame)
- thumb turn cylinder lock
- door closer against an additional charge

## DOOR FRAMES

- fire rated fixed door frame
- fire rated gasket
- adjustable door striker plate
- adjustable steel, square large or welded frames in RAL 9010, 8003, 8017, 7035, 7016, 1005
- fixed frame made of black sheet metal, thickness 1.5 mm, RAL powder painted, welded in the corners, fitted with a fire rated gasket and door closer reinforcement as standard.

## ADDITIONAL CHARGES

fire rated door closer with scissor arm  
colours: silver, black, white, brown

---

fire rated cam-action door closer  
(For frames with or without housing with a clip-on square)  
colours: silver, black, white, brown

---

fire rated ventilation grille

---

JOVE INOX handle, long face plate, lock core, see p. 127

---

30/40 lock core (EI30) or 30/50 (EI60)

---

fire-proof door viewer, satin, chrome

---

fire rated upper deadbolt lock

---

black door leaf edge finish

---

housing for EI30 from 100 to 460 and  
housing for EI60 from 120 to 480 every 40 mm  
double door housing

---

fire rated electric door strike  
(standard) 12/24V (not for the steel door frame)

---

steel door frame in RAL not in the range (intensive, pearl and metallic colours not included)

---

steel door frame made of galvanised sheet steel

---

EI30  
Extra charge for Type 3, 4, 4, 5, 6, 8 glazing

---

EI60  
Extra charge for Type 4, 6, 8 glazing

---

LUX INLAY: available versions p. 80-81  
(on both sides on a full door leaf, and on an active double-leaf only)

---

CPL 0.2 laminate (for doors w/o housing)

---

CPL 0.7 laminate (for doors w/o housing)

---

clip-on square <sup>1)</sup> **NEW**  
(the clip-on square extends the adjustment range by 20 mm)

---

additional charge for the "110" leaf

---

side and top panels glued to the wall available (only with a wall installed door frame and an 8 cm square)

---

**NEW**

<sup>1)</sup> In the version with housing, the clip-on square is included



# LEDA EI30, EI60

## SINGLE-LEAF DOOR

### FIXED WOODEN DOOR FRAME

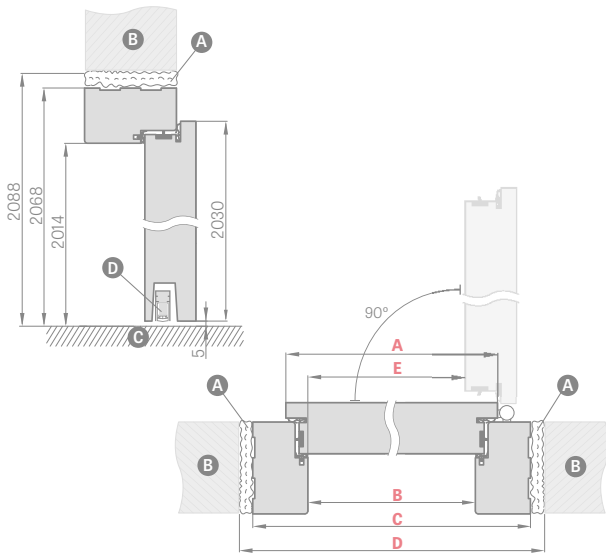

Door width	A	B	C	D	E
"80"	860	817	925	955	805
"90"	960	917	1025	1055	905
"100"	1060	1017	1125	1155	1005
"110"	1160	1117	1225	1255	1105

- A** fire-resistant installation foam
- B** wall
- C** floor
- D** drop-down gasket

### FIRE RATED DOOR FRAME CROSS-SECTION IN MASONRY AND WITH CLIP-ON SQUARE

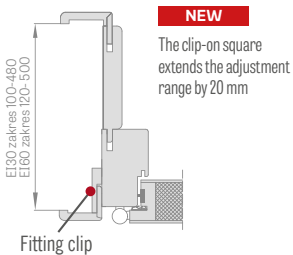

### FIRE RATED DOOR FRAME CROSS-SECTION IN BASIC MASONRY

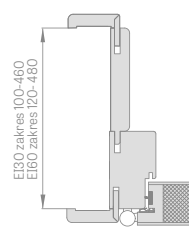

### CLIP-ON SQUARE, 6 cm and 8 cm with clips

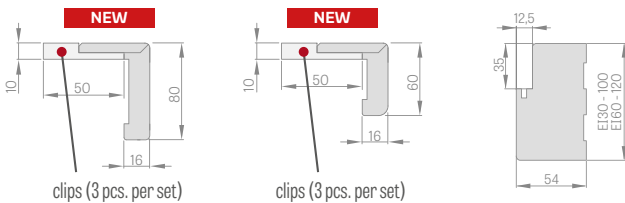

### DOOR CLOSER TRACK MOUNTED DOOR CLOSER<sup>1)</sup>



### DOOR CLOSER WITH SCISSOR ARM



### ADJUSTABLE STEEL FIRE DOOR FRAME (OVERLAPPING)

Welded and coated in RAL 9003, 9010, 9016, 8003, 8017, 7016, 7022, 7047, 1001

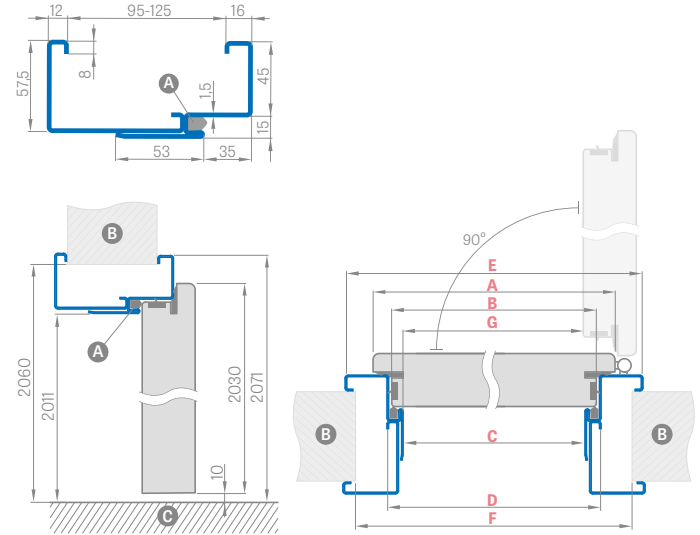

Door width	A	B	C	D	E	F	G
"80"	860	834	813	843	933	910	802
"90"	960	934	913	943	1033	1010	902
"100"	1060	1034	1013	1043	1133	1110	1002
"110"	1160	1134	1113	1143	1233	1210	1102

### LARGE STEEL FIRE SQUARE DOOR FRAME (OVERLAPPING)

Welded and coated in RAL 9003, 9010, 9016, 8003, 8017, 7016, 7022, 7047, 1001

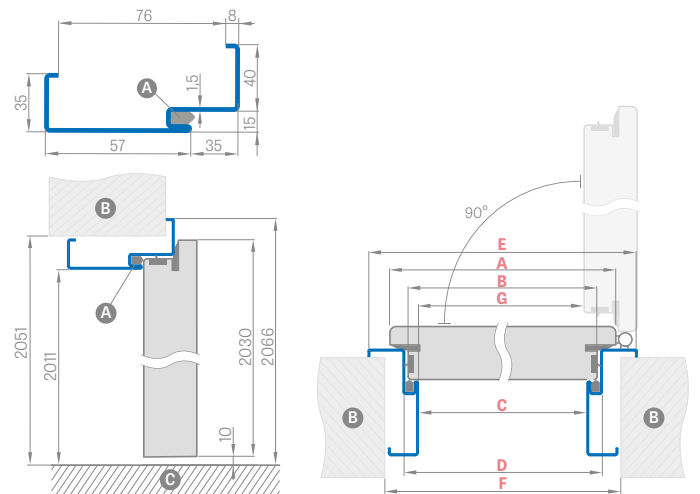

Door width	A	B	C	D	E	F	G
"80"	860	834	813	843	923	890	802
"90"	960	934	913	943	1023	990	902
"100"	1060	1034	1013	1043	1123	1090	1002
"110"	1160	1134	1113	1143	1223	1190	1102

### RAL



RAL 9003<sup>2)</sup> RAL 9010 RAL 9016 RAL 8003 RAL 8017 RAL 7016 RAL 7022<sup>2)</sup> RAL 7047 RAL 1001

<sup>1)</sup> use the cam action door closer for a fixed door frame only or for frames with a clip-on square

<sup>2)</sup> additional charge +10%



# LEDA EI30, EI60

## DOUBLE-LEAF DOORS

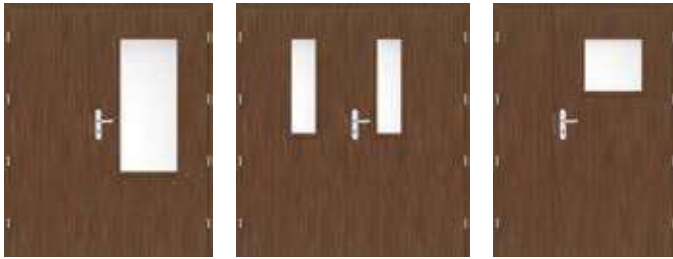

LEDA 3 "90"  
+ passive "60" door leaf

LEDA 6 "90"  
+ passive "80" door leaf

LEDA 4 "90"  
+ "40" side panel

### LEDA EI30 & EI60 DOUBLE-LEAF DOORS

- The double-leaf doors are made within the LEDA EI30 and EI60 ranges with prices depending on the colour and finish (STANDARD);
- The passive leaf is made in two versions:
  - Plain; widths: "60", "70", "80"
  - glazed in types 5, 6, 7, 8 for EI30 and glazed in types 6 and 8 for EI 60
- Side panel for the widths of "30", "40" and "50"; fully plain in each variant;
- The passive leaf and side panel are supplied with shootbolt locks and bolt keepers; w/o edging strips.

### AVAILABLE ACTIVE DOOR LEAF WIDTHS FOR DIFFERENT FIRE DOOR TYPES

LEDA	LEDA Type 3 glazing	LEDA Type 4 glazing	LEDA Type 5 glazing
EL30 EL60 80 90 100	EL30 90 100	EL30 EL60 90 100	EL30 80 90 100
LEDA Type 6 glazing	LEDA Type 7 glazing	LEDA Type 8 glazing	
EL30 EL60 80 90 100	EL30 80 90 100	EL30 EL60 80 90 100	

### AVAILABLE PASSIVE DOOR LEAF WIDTHS FOR DIFFERENT FIRE DOOR TYPES

LEDA	LEDA Type 5 glazing	LEDA Type 6 glazing
EL30 EL60 60 70 80	EL30 70 80	EL30 EL60 70 80
LEDA Type 7 glazing	LEDA Type 8 glazing	
EL30 70 80	EL30 EL60 70 80	

### DOUBLE-LEAF DOOR PRICE

The price includes

- Active part = price of full single leaf door, plus possible extra charges as for single leaf doors
- Passive part = price for the full version (also side panel), plus possible extra charges as for single leaf doors

### AVAILABLE DOOR LEAF WIDTHS

active leaf **80 90 100** + passive leaf **60 70 80**  
 active leaf **80 90 100** + full, plain side panel **30 40 50**

	DOUBLE FIRE DOOR   TIMBER DOOR FRAME								
	"110"	"120"	"130"	"140"	"150"	"160"	"170"	"180"	
<b>A</b> Active door leaf width	860	860   960	860   960   1060	860   960   1060	860   960   1060	860   960   1060	960   1060	1060	
<b>B</b> Passive door leaf/Side panel widths	347	447   347	547   447   347	647   547   447	747   647   547	847   747   647	847   747	847	
<b>C</b> Frame opening width	1170	1270	1370	1470	1570	1670	1770	1870	
<b>F</b> Frame outer width	1278	1378	1478	1578	1678	1778	1878	1978	
<b>E</b> Opening width in the wall	1310	1410	1510	1610	1710	1810	1910	2010	

### ADJUSTABLE STEEL FIRE DOOR FRAME (OVERLAPPING)

Welded and coated in RAL 9010, 9016, 8003, 8017, 7016, 7047, 1001

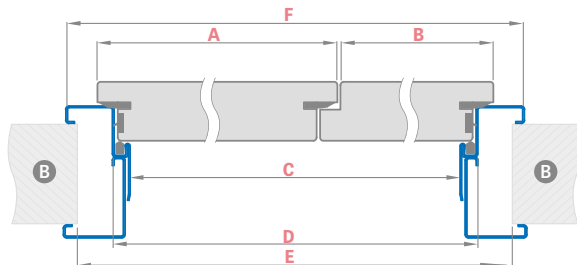

Door Width	A	B	C	D	E	F
"110"	860	347	1166	1196	1270	1287
"120"	860   960	447   347	1266	1296	1370	1387
"130"	860   960   1060	547   447   347	1366	1396	1470	1487
"140"	860   960   1060	647   547   447	1466	1496	1570	1587
"150"	860   960   1060	747   647   547	1566	1596	1670	1687
"160"	860   960   1060	847   747   647	1666	1696	1770	1787
"170"	960   1060	847   747	1766	1796	1870	1887
"180"	1060	847	1866	1896	1970	1987

### LARGE STEEL FIRE SQUARE DOOR FRAME (OVERLAPPING)

Welded and coated in RAL 9010, 9016, 8003, 8017, 7016, 7047, 1001

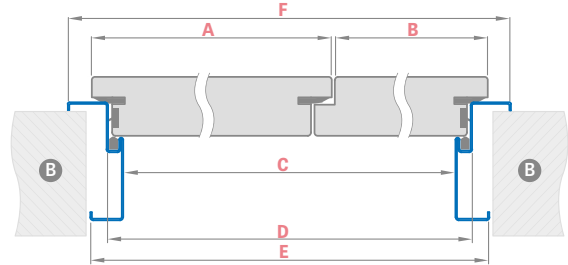

Door Width	A	B	C	D	E	F
"110"	860	347	1166	1196	1236	1276
"120"	860   960	447   347	1266	1296	1336	1376
"130"	860   960   1060	547   447   347	1366	1396	1436	1476
"140"	860   960   1060	647   547   447	1466	1496	1536	1576
"150"	860   960   1060	747   647   547	1566	1596	1636	1676
"160"	860   960   1060	847   747   647	1666	1696	1736	1776
"170"	960   1060	847   747	1766	1796	1836	1876
"180"	1060	847	1866	1896	1936	1976



# HYPERION EI30 RC2 39dB

INTERNAL FRONT FIRE AND BURGLAR-PROOF DOORS MADE IN THE ERKADO TECHNOLOGY

Presented model: HYPERION with NATUR OAK PREMIUM laminate and a BONNN handle, LUX 213 inlay



## AVAILABLE DOOR LEAF WIDTHS

80 90 100

## DOOR LEAF WITH FIXED TIMBER DOOR FRAME

HYPERION EI30 Leaf + fixed timber door frame

“80”

“90”

“100”

## GREKO

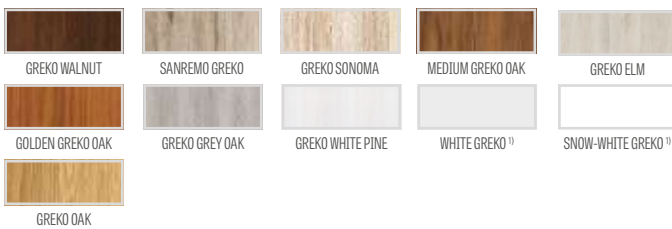

## FINISH



## CPL



## PREMIUM

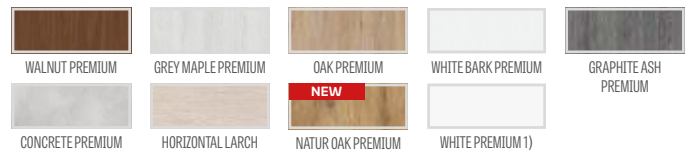

<sup>1)</sup> plain white laminate imitating a painted surface

<sup>2)</sup> special AntiFinger coating to reduce dirt and fingerprints

**GENERAL INFORMATION**

Fire protection, smoke control and sound insulation are ensured only when a complete doorset is installed, including a fire door leaf (with gaskets, lock, hinges and drop-down gasket pre-assembled), door frame, door closer, as well as a lock core and handle in compliance with the Polish Standard.

The sound insulation of the door with a drop-down gasket as per PN-B-02151-03:1999 is rated at  $R_w=39$  dB

The door leaves are sold complete with a wooden door frame only.

The doors have an anti-burglary RC2 certificate for inward opening doors.

**CONSTRUCTION**

- special 44 mm thick filling
- total door leaf thickness of 50 mm
- softwood door frame
- fire rated and smoke intumescent door gasket
- drop-down gasket

**FINISHING**

- leaf edge made in the STANDARD technology (with CPL 0.2 & 0.7 laminates, laminated with the ABS edging in the same colour as the leaf only) or with a standard black edge against an additional charge
- 8 mm or 200 mm wide brushed steel, black or OAK CPL inlays flush with the door leaf, on both leaf sides **NEW**
- the edge laminated in the same colour as the door leaf or, optionally plain black (transverse larch, black edge with a transverse structure) **NEW**
- side and top panels glued to the wall (only when fitted with an 8 cm square) - page 134 **NEW**

**HARDWARE**

- four hinges;  $\varnothing 16$ ; 3D adjustable
- multi-point bolt strip lock with two locks
- door closer against an additional charge

**DOOR FRAMES**

- fixed wooden fire protection door frame optionally with cladding
- fire rated gasket
- adjustable door striker plate

**FIRE RATED DOOR FRAME CROSS-SECTION IN MASONRY AND WITH CLIP-ON SQUARE**

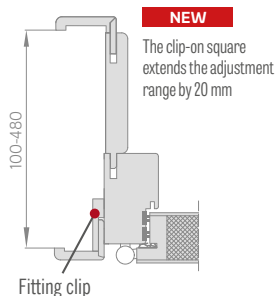

**FIRE RATED DOOR FRAME CROSS-SECTION IN BASIC MASONRY**

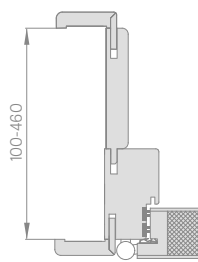

**CAM-ACTION DOOR CLOSER <sup>2)</sup>**  
(silver, black, white, brown)



**ARM DOOR CLOSER**  
(silver, black, white, brown)



<sup>1)</sup> in the version with housing, the clip-on square is included

<sup>2)</sup> use the cam-action door closer for a fixed door frame only or for frames with a clip-on square

**ADDITIONAL CHARGES**

fire rated door closer with scissor arm  
colours: silver, black, white, brown

fire rated cam-action door closer  
(For frames with or without housing with a clip-on square)  
colours: silver, black, white, brown

BONN handle, long face plate, lock core, see p. 127

BONN face plate (page 127)

core 30/40 (EI30)

fire-proof door viewer, satin, chrome

black door leaf edge finish

cladding for EI30 from 100 to 480 mm

LUX inlay; available versions p. 80-81

CPL 0.2 laminate (for doors w/o housing)

CPL 0.7 laminate (for doors w/o housing)

clip-on square <sup>1)</sup> **NEW**  
(the clip-on square extends the adjustment range by 20 mm)

side and top panels glued to the wall available (only with a wall installed door frame and an 8 cm square)

**FIXED WOODEN DOOR FRAME**

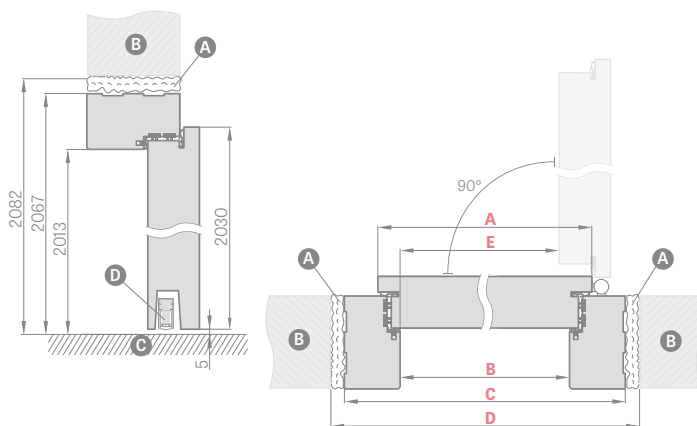

Door width	A	B	C	D	E
"80"	860	817	925	955	805
"90"	960	917	1025	1055	905
"100"	1060	1017	1125	1155	1005

**A** fireproofing foam **B** masonry **C** floor **D** drop gasket

**CLIP-ON SQUARE, 6 cm and 8 cm with clips**

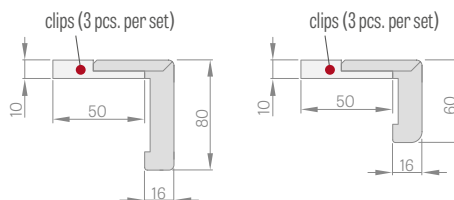

**FIRE RATED FIXED DOOR FRAME CROSS-SECTION**

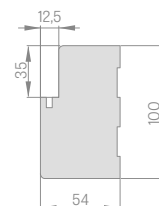



# HARDWARE

## HANDLES FOR PANEL, STILE DOOR LEAVES

The handle not to be used for panel door leaves with casing frames, see p. 158

NEW

### RUMBA handle with antibacterial coating with active silver ions

black matt



black matt



key face plate  
face plate  
anti-bacterial toilet sign knob



NEW

### METAL-BUD LUNA PREMIUM handle, SQUARE

glossy chrome, brushed matt chrome, glossy brass, black matt

Metal-Bud

PRODUCENT KLAMEK



Glossy chrome



brushed matt chrome



glossy brass



black matt



key face plate  
face plate  
face plate for toilet door

HANDLE CLASS  
PREMIUM

### METAL-BUD LUNA PREMIUM handle, ROUND

glossy chrome, brushed matt chrome, glossy brass, black matt

Metal-Bud

PRODUCENT KLAMEK



glossy chrome



brushed matt chrome



glossy brass



black matt



key face plate  
face plate  
face plate for toilet door

HANDLE CLASS  
PREMIUM



## HANDLES FOR PANEL, STILE DOOR LEAVES

The handle not to be used for panel door leaves with casing frames, see p. 158

**NEW**

### METAL-BUD CUBE SLIM handle (face plate width 6 mm)

glossy chrome, brushed matt chrome, glossy brass, black matt

**Metal-Bud**

PRODUCENT KLAMEK



glossy chrome



brushed matt chrome



glossy brass

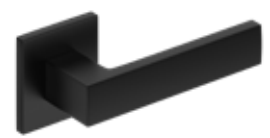

black matt



key face plate  
face plate  
face plate for toilet door

HANDLE CLASS  
**PREMIUM**

### METAL-BUD CUBE handle

glossy chrome, brushed matt chrome, brushed matt nickel, black matt



glossy chrome



brushed matt chrome



brushed matt nickel

**NEW**



black matt



key face plate  
face plate  
face plate for toilet door

HANDLE CLASS  
**PREMIUM**

### METAL-BUD CUBE PREMIUM handle

glossy chrome, brushed matt chrome, brushed matt nickel, black matt



glossy chrome



brushed matt chrome



brushed matt nickel

**NEW**



black matt



key face plate  
face plate  
face plate for toilet door

HANDLE CLASS  
**PREMIUM**

## HANDLES FOR PANEL, STILE DOOR LEAVES

The handle not to be used for panel door leaves with casing frames, see p. 158

NEW

### METAL-BUD BELLA SLIM SQUARE (prestige face plate of 6 mm in thickness)

glossy chrome, brushed matt chrome, glossy brass, black matt

**Metal-Bud**

PRODUCENT KLAMEK



glossy chrome



brushed matt chrome



glossy brass



black matt

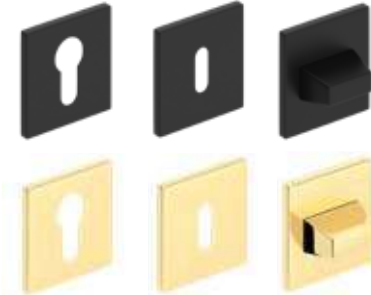
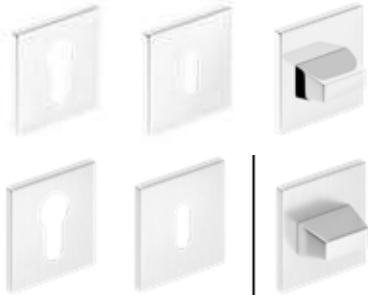

key face plate  
face plate  
face plate for toilet door

HANDLE CLASS  
**PREMIUM**

NEW

### METAL-BUD BELLA SLIM ROUND (prestige face plate of 6 mm in thickness)

glossy chrome, brushed matt chrome, glossy brass, black matt



glossy chrome



brushed matt chrome



glossy brass



black matt

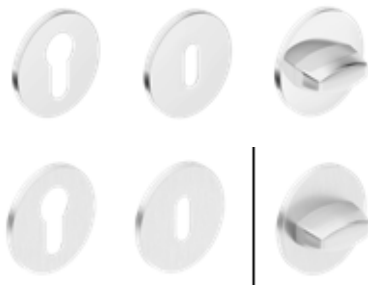

key face plate  
face plate  
face plate for toilet door

HANDLE CLASS  
**PREMIUM**

### METAL-BUD TREND handle

Nickel satin, graphite/chrome, glossy chrome



Nickel satin



Graphite/chrome



glossy chrome



key face plate  
face plate  
face plate for toilet door

## HANDLES FOR PANEL, STILE DOOR LEAVES

The handle not to be used for panel door leaves with casing frames, see p. 158

### METAL-BUD DECO texture handle

glossy chrome, nickel satin

**Metal-Bud**

PRODUCENT KLAMEK



decor: MEDIUM GREKO OAK



decor: BLACK



decor: WHITE GREKO



decor: GREKO SONOMA



decor: GREKO WALNUT



decor: GREKO OAK



decor: SANREMO GREKO

### METAL-BUD IBIZA handle

glossy chrome, nickel satin, graphite/chrome, white matt, black matt



glossy chrome



Graphite/chrome



nickel satin



White matt



black matt

### METAL-BUD LINEA handle

Glossy chrome, graphite/chrome, nickel, satin



glossy chrome



Graphite/chrome



nickel satin

**FACE PLATE** glossy chrome, nickel satin, graphite/chrome, white matt, black matt for the **DECO, IBIZA, LINEA** models



key face plate  
face plate  
face plate for toilet door

## HANDLES FOR PANEL, STILE DOOR LEAVES

The handle not to be used for panel door leaves with casing frames, see p. 158

NEW

### METAL-BUD QUBIK handle

nickel velvet, chrome glossy, white matt, black matt

**Metal-Bud**

PRODUCENT KLAMEK



NEW

QUBIK handle nickel, velvet



NEW

QUBIK handle chrome glossy



NEW

QUBIK handle, white matt



NEW

QUBIK handle, black matt

### METAL-BUD BARCELONA handle

nickel, velvet, glossy chrome, black matt



BARCELONA handle nickel, velvet



NEW

BARCELONA handle glossy chrome



NEW

BARCELONA handle, black matt

**FACE PLATE** nickel, velvet, glossy chrome, white matt, black matt for the **QUBIK, BARCELONA** models



key face plate  
face plate  
face plate for toilet door

### METAL-BUD ERKADO handles

stainless steel



SAPPHIRE INOX handle



METRO INOX handle



PROXIMA INOX SQUARE handle



TOPAZ INOX handle



ONYX INOX handle



NOVA INOX SQUARE handle



NOVA INOX handle, round



JOVE INOX handle



ROMA INOX handle



face plate



Key face plate



face plate for toilet door



face plate



Key face plate



face plate for toilet door

## HANDLES FOR PANEL, STILE DOOR LEAVES

The handle not to be used for panel door leaves with casing frames, see p. 158

### METAL-BUD ERKADO handle

black matt



TOPAZ handle, black matt



face plate



Key face plate



face plate for toilet door

### METAL-BUD SIRIUS handle

black matt



SIRIUSZ handle, black



face plate



Key face plate



face plate for toilet door

NEW

### APRILE handles

polished chrome, satin chrome, black, gold, matt gold, copper



PINA handle, polished chrome



PINA handle chrome, satin



PINA handle, black



PINA handle gold



PINA handle, matt gold



PINA handle, copper



JUKA handle, polished chrome



JUKA handle chrome, satin



JUKA handle, black

### FACE PLATE polished chrome, satin chrome, black, gold, matt gold, copper for PINA, JUKA models



face plate,



face plate for toilet door



face plate,



face plate for toilet door



face plate,



face plate,



face plate for toilet door



## HANDLES FOR PANEL, STILE DOOR LEAVES

The handle not to be used for panel door leaves with casing frames, see p. 158

### GAMET handles

brushed chrome, glossy chrome, brushed nickel, antique brass



MISTICO handle  
glossy chrome



MISTICO handle  
brushed nickel



face plate for key and lock core  
face plate for toilet door



ERBA handle  
brushed nickel



ERBA handle  
antique brass



face plate for key and lock core  
face plate for toilet door



CASCADA handle  
brushed nickel



CASCADA handle  
antique brass



face plate for key and lock core  
face plate for toilet door

## HANDLES FOR PLATE, STILE LEAVES, WITH LONG FACE PLATE

The handle not to be used for panel door leaves with casing frames, see p. 158

(DOES NOT APPLY TO SYDNEY and QUBIK handles, long face plate). The handles with a long face plate are not to be used for non-rebated doors (see p. 132)

### METAL-BUD ASTRA, SYDNEY and QUBIK handles, long face plate, spacing 72 mm

- the SYDNEY and QUBIK handles not to be used for panel door leaves with casing frames, see p. 158

**Metal-Bud**

PRODUCENT KLAMEK

nickel, patina



ASTRA handle  
nickel, patina  
Key face plate



ASTRA handle, nickel, satin  
face plate



**NEW**

SYDNEY handle  
nickel, patina  
Key face plate



ASTRA handle, nickel, satin  
face plate, economy



**NEW**

QUBIK handle long face plate  
Black  
Key face plate



QUBIK handle, black  
face plate



QUBIK handle, black  
face plate for toilet door

## HANDLES FOR PLATE, STILE LEAVES, WITH LONG FACE PLATE

The handle not to be used for panel door leaves with casing frames, see p. 158  
(DOES NOT APPLY TO SYDNEY and QUBIK handles, long face plate). The handles with a long face plate are not to be used for non-rebated doors  
(see p. 132)

**NEW**

### METAL-BUD JOVE INOX handles, long face plate (10 mm thick)

**CERTIFIED FOR USE IN LEDA EI30 AND EI 60 FIRE AND FRONT DOORS**

**Metal-Bud**

PRODUCENT KLAMEK

Stainless steel, investment



JOVE INOX handle  
Key face plate



JOVE INOX handle  
face plate for toilet door



JOVE INOX handle  
face plate



JOVE INOX handle  
face plate, economy

### METAL-BUD TOPAZ INOX handle, long face plate (10 thick), spacing 72 mm

stainless steel



TOPAZ INOX handle  
Key face plate



TOPAZ INOX handle  
face plate for toilet door



TOPAZ INOX handle  
face plate



TOPAZ INOX handle  
face plate, economy

## HANDLES FOR HERSE SET, HERSE LUX SET, HERSE MAX SET

handle METAL-BUD ERKADO BONN and ESSEN (face plate thickness ESSEN - 10 mm, BONN - 8 mm), spacing 72 mm



BONN handle and face plate



BONN handle and face plate, black



ESSEN handle and face plate



**NEW**

black matt

## LOCK CORES



Lock core  
Nickel satin



Lock core with thumbturn  
Nickel satin

LOCK CORE	LOCK CORE WITH THUMBTURN
Size	Size
26/36	G30/40
30/30	G40/30
30/45	G30/50
30/50	G50/30
	30/45G
	30G/45

Lock cores in the master key system 30/45 + 30G/45  
Outwards opening doors

Lock cores in the master key system 30/45 + 30/45G  
Inwards opening doors



# TECHNICAL INFORMATION

## DOOR OPENING DIRECTIONS

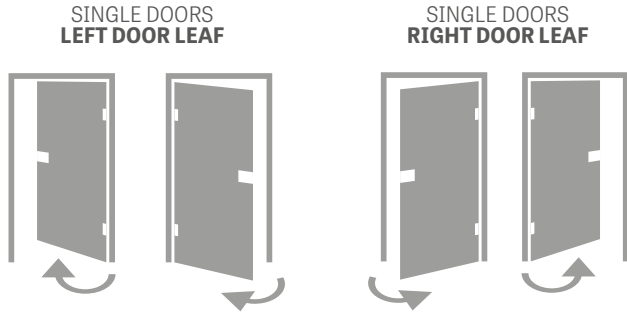

## REBATED, NON-REBATED, REVERSE DOORS

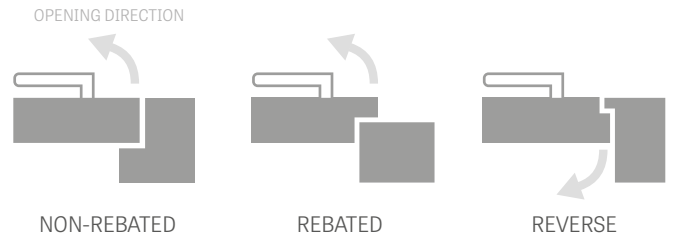

## DOUBLE DOORS

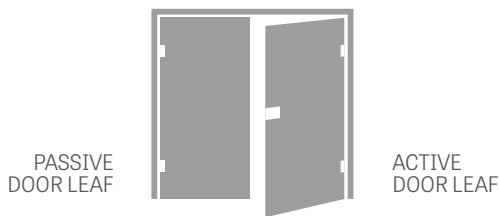

## DOOR FRAME JOINTS



## HOW TO SELECT A LOCK CORE

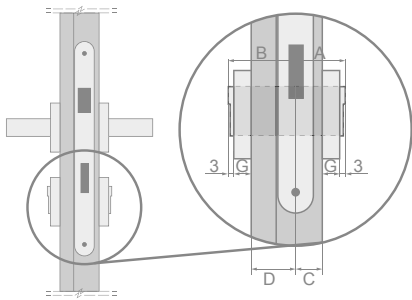

Example of calculating the lock core size for the flush and stile doors (40mm) with the face plate thickness of  $G = 7$  mm

$$A/B = (C+G+3) / (D+G+3)$$

$$A/B = (15+7+3) / (25+7+3)$$

$$A/B = 25/35$$

Door type	Door leaf thickness	Proportion of lock setting in door (C/D)	Recommended lock core size (A/B)*
Flush, stile (rebated)	40 mm	15/25	26/36
Flush, stile (non-rebated)	40 mm	20/20	30/30
HERSE	46 mm	15/31	30/45
LEDA EI 30	50 mm	19/31	30/40
LEDA EI 60	60 mm	19/41	30/50
FORTECA RC2 & RC3	46 mm	20/26	30/40
HYPERION EI30 RC2	50 mm	19/31	30/40

\* Recommended lock core size for the escutcheon thickness of 7 mm and play of 2 mm to 4 mm

## HOW TO CALCULATE DOOR PRICE

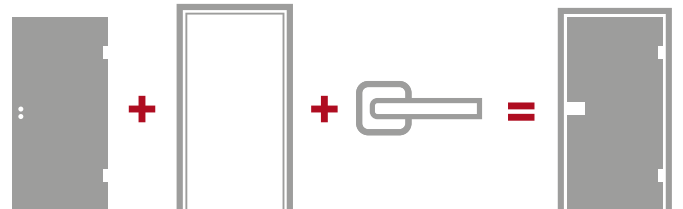

## AVAILABLE SOLUTIONS (pp. 135-143)

- wall-mounted sliding door systems, single door

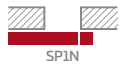

- wall-mounted sliding door systems, double-leaf doors



- pocket sliding door systems, single-leaf doors



- pocket sliding door systems, double-leaf doors

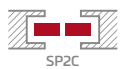

- supplementary system ZN1



- supplementary system ZN2



- double-leaf doors





## DOOR FACE FINISH TYPES

### FINISH

The Finish laminate is pre-impregnated, which means printing and then coating with paint with required properties. Using the performance finishing coats adds to the surface's basic resistance.

### GREKO

The Greko laminate is also pre-impregnated, which means printing and then coating with paint with required properties. Using the performance finishing coats adds to the surface's resistance and flexibility of the product. The paint's silicon content ensures the film resistance is enhanced.

The Greko laminate is manufactured on a high density Japanese base layer which is not resin coated. This makes the film ecological, healthy and safe for people and environment both in the production process and during use, as well as for disposal. No formaldehyde or other harmful ingredients is used.

Its distinctive patterns are what distinguishes the Greko film. The laminates bear striking resemblance to wood, as the high quality surface comes with a 3D natural wood effect. Woodgrain decors look just like wood

### PREMIUM

The Premium laminate is a product based on Polypropylene (PP), a material of very high resistance to abrasion and scratching, plus top quality appearance. It adds a refined looks and individual character to the doors, as it imitates natural wood perfectly.

Not only does the Premium laminate attracts with its appearance but with its functionality, as it resists scratching better than average products and is fire-retardant and abrasion resistant.

These properties ensure the extended longevity and maintenance-free use of the PREMIUM range products even in most adverse conditions.

### ST CPL, CPL 0,2 and CPL 0,7

The CPL laminate is composed of a decorative layer impregnated in resins, and a base layer ensuring flexibility. Following the lamination process, the top resin layer is hardened for high resistance to scratching and abrasion. It is characterised by high resistance to impact, abrasion, scratching, heat and UV radiation

Thanks to using this type of material, the door can be installed in so-called "difficult" interiors [exposed to heat, moisture or extraordinary use]. Approx. laminate thickness: ST CPL - 0,15 mm, CPL 0,2 - 0,2 mm and CPL 0,7 - 0,7 mm. The CPL 0,7 laminate is used to cover only one leaf plane thanks to its unique hardness. The CPL 0,2 and CPL 0,7 laminated door leaves come with the leaf edge made of the so-called ABS, a highly durable PVC.

ST CPL laminate in decors white, light grey, cappuccino, black has been refined in the AntiFinger coating limiting dirt and fingerprints. **NEW**

### UV VARNISH

The door surface has several coats of the WHITE TITANIUM UV modern UV hardened varnish.

The flat surfaces are covered with a specialist base membrane in the first phase, and then coated twice with a top quality paint and hardened with UV.

The moulded surfaces cannot be covered with the membrane for technological reasons, so they are coated with three paint layers and hardened with UV.

The fully automatic coating process follows scanning to ensure ideal quality of the surface. Hardening the paint with the cutting-edge method involving UV light source ensures very high mechanical resistance.

## EDGE FINISH TYPES

### EDGE SOFT



The SOFT door leaf comes with a chamfered edges, which lends an aesthetic and modern look to it. The leaf is finished with a laminate of an improved resistance to scratching, which dramatically enhances its resistance during use.



### STANDARD EDGE



It involves covering the flat plane with the 0.15 mm ST CPL laminate, CPL 0.2, CPL 0.7 laminates, polypropylene PREMIUM laminate, GREKO laminate or FINISH film.

The door leaf made in STANDARD technology has unchamfered edges, which is where the face panel is joined with edging laminate, as shown in the diagram. The laminate in the CPL 0.2 and CPL 0.7 laminates is made of very durable PVC, the so-called ABS. The joining method of the laminate is also identical for the non-rebated doors and non-rebated sliding systems.



<sup>1)</sup> applies only to BALDUR 1 in WHITE ST CPL laminate

## STILE DOOR LEAF

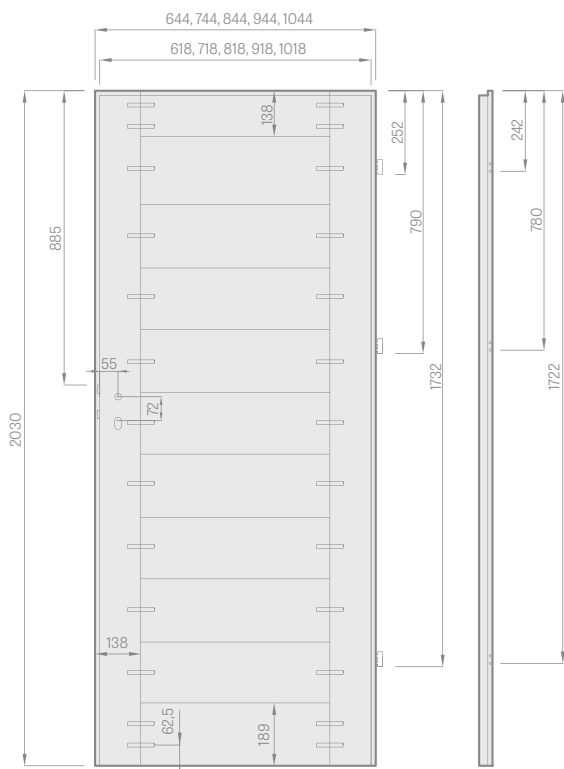

Rebated door leaf



- A** MDF or timber stiles in PREMIUM laminate
- B** MDF rails

## PANEL DOOR LEAF

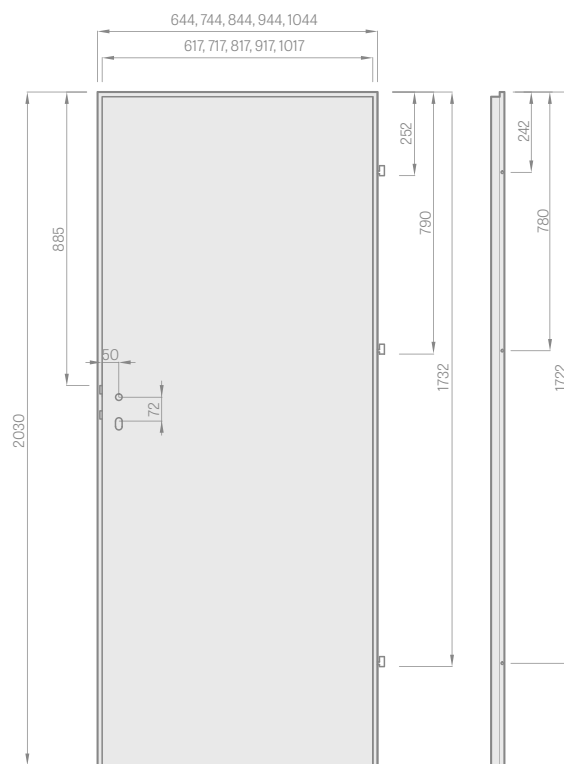

Rebated door leaf



HERSE SET leaf



SOFT & STANDARD leaf



NON-REBATED door leaf

- A** MDF board; **B** gasket; **C** HDF board; **D** filling;
- E** MDF or timber stiles in Herse SET and UNO PREMIUM



Solid 35 mm or 22 mm thick rail



Aesthetic frameless tongue-and-groove glazing without bars

## FILLING TYPES

Honeycomb



solid core filling



MDF stile for GREKO and CPL laminates with the AntiFinger coating **NEW**



Glulam timber stile for PREMIUM and CPL surfaces without the AntiFinger coating

Honeycomb and solid core filling in the panel doors ONLY. For the flush doors we add a third hinge as standard.

## GRAF GLASS PANEL

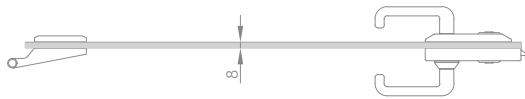
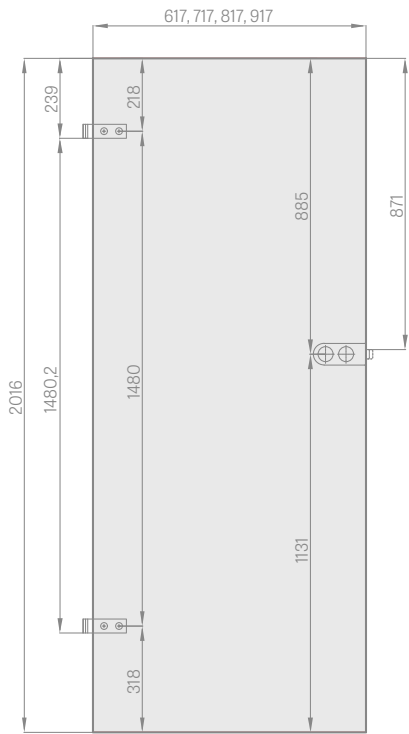

## FIRE DOOR LEAF

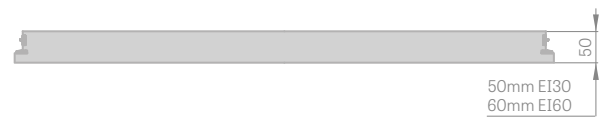
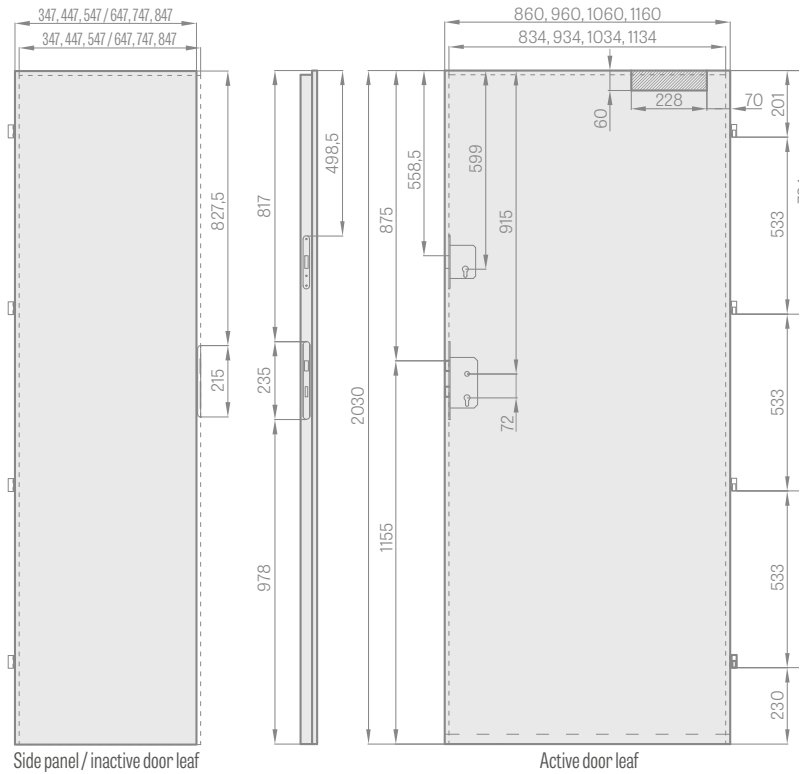

## BATHROOM TURN & RELEASE

outside (Z)

inside (W)

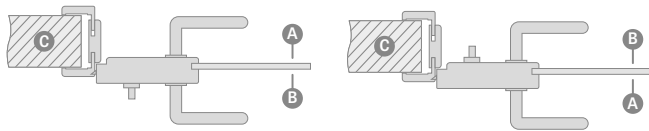

**A** Corridor; **B** Bathroom; **C** Wall

Bathroom lock – for turn and release locks, select:

OUTSIDE lock

– with the bathroom turn and release is fitted to the outside of the door (Z)

or

INSIDE lock

– with the bathroom turn and release is fitted to the inside of the door (W)

NOTE: Directions for the turn and release locks apply (R/L)

## STANDARD OBLVERSE GLAZING



## MADE TO ORDER REVERSE GLAZING:



**G** plain side; **M** ornamental matt side;



Specially designed HALSPAN board filling  
44 mm [EI30] /  
54 mm [EI60]



Fire rated and smoke intumescent door gasket in red or black



drop-down gasket with pressure adjustment by Allen key



Fixed door frame



Useful four hinges; Ø16, 3D adjustable

## CONCEALED MAGNETIC STOPS NEW



chrome glossy, chrome satin, brass glossy, colourless, white semi-matt, black semi-matt

We assemble the magnetic door stop in a special place milled for this purpose on our own.

Product delivered as a separate assortment.

Caution (important information in case of underfloor heating): the floor element should be placed in the  $\varnothing 14\text{mm}$  hole, 45 mm deep.

## METAL CAPS FOR HINGES



Brushed nickel, patina, glossy chrome, glossy brass, white matt and black matt

Cap sizes:

- ID 16 mm for HERSE SET and FORTECA door types and fire-rated LEDA AND HYPERION
- ID 15 mm for panel and stile doors
- length 47 mm

## VENTILATION



Plastic sleeves for FINISH colour group

Plastic woodgrain sleeves for STILE doors with GREKO, PREMIUM and CPL decors



Square and round metal sleeves



Grilles

## VENTILATION

Ventilation door cut not available in non-rebated door leaves for wall-mounted and pocket sliding doors.

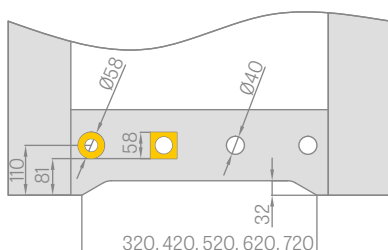

## ELECTRIC DOOR STRIKE

(Available for fixed and adjustable door frames for rebated doors, see p. 161-163, but unavailable for the door frames used with the GRAF glass panes and double-leaf doors)



Types of electric door strikes:

- basic 12 V
- basic 24 V
- switch operated 12 V
- switch operated 24 V
- reverse 12 V
- reverse 24 V

BASIC

SWITCH OPERATED

REVERSE

- normally closed, and opened when voltage is fed
- same operation as in the basic strike, but with an option to be switched off by moving the springbolt
- closed when voltage is fed, opened when not

The reverse and switch operated electric door strikes unavailable for the fire doors

## CUTTING THE DOOR LEAVES

Cutting the door leaves to size by customer acc. to Polish standard, up to 50 mm, or up to 80 mm for the HERSE SET door leaves (unless pre-cut), as well as in the panel door leaves, is possible if an additional lower strip has been fitted by the manufacturer.

(NOTE: cutting the door leaves to size by customer is not allowed for the FRAGI doors, double-leaf and fire doors, non-rebated leaves for sliding systems, glass GRAF doors, FORTECA RC2 and FORTECA RC3 burglar-proof doors, and stile doors acc. to the CZ standard).

**The door leaf height made acc. to the so-called CZ standard is lower than the PL standard by 47 mm.**

## CLEANING, REVITALISATION & REGENERATION KIT FOR OTTI-MO DOORS



## HARDWARE

### DEADBOLT LOCKS

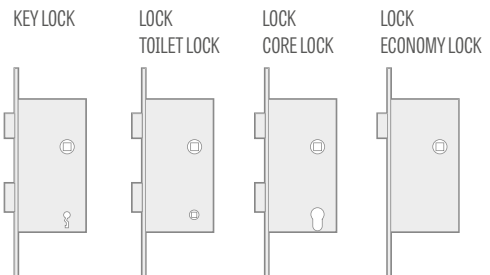

LOCK PZ CENTRES:

1. For rebated door leaves, the PZ centre of the key operated deadbolt lock, toilet lock and core lock is 72 mm.
2. For non-rebated and reverse door leaves, the PZ centre of the magnetic lock is:
  - 90 mm (key operated and toilet locks)
  - 85 mm (core locks)

The toilet locks have a square-shaped bolt hole:

- acc. to PL standard: 4 mm
- acc. to CZ standard: 6 mm

### STANDARD "OBSERVE" GLAZING

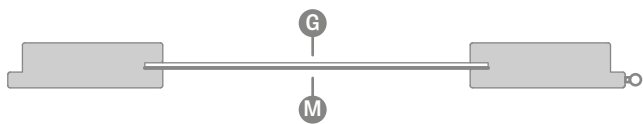

### "REVERSE" GLAZING MADE TO ORDER

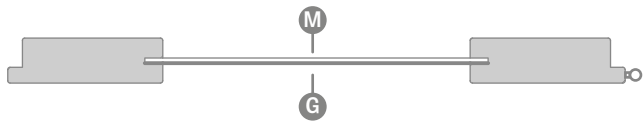

G plain side M matt side with decoration or colourless side with decoration

### FROSTED and BLACK VSG 221, 331, 441 LAMINATED GLASS for STILE and panel doors

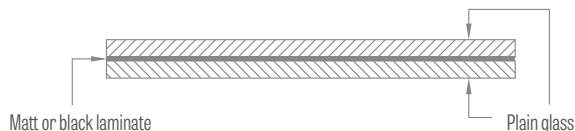

### CLEARANCE UNDER DOOR LEAF AFTER INSTALLATION

Please check the lower clearance dimensions on all products prior to installation, as the allowable deviation due to frame dimensional tolerance is +/- 3mm

### GLAZING TRANSLUCENCY ILLUSTRATION

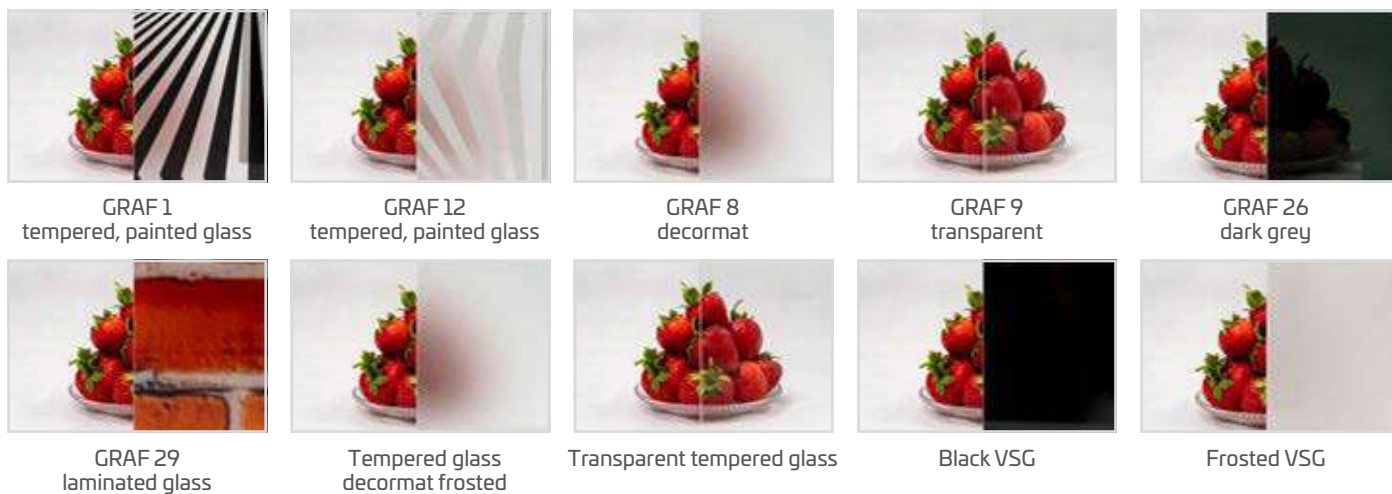

### FACTORY-DRILLED HANDLE OPENINGS

NEW



Drilling of openings for the handle in stile doors in the PREMIUM and ST CPL laminates for handles with a split face plate available in the Erkado offer.

### NON-REBATED HARDWARE



Concealed hinge

Magnetic catch

Adjustable magnetic catch strike

### INSTALLATION OF FRAME FOR NON-REBATED DOOR FRAMES

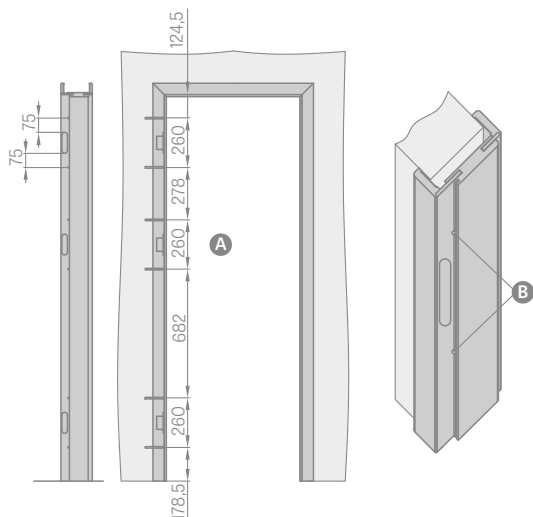

- A Drill holes for metal screws of min length 80 mm x Ø6 mm
- B Apart from installation foam, mounting anchors are required when installing the door frame. Drill the holes for screws under the gasket so that it hides them.



Concealed hinge, black

Magnetic lock, black

Adjustable magnetic catch strike, black



Door leaf flush with the frame



# DOOR FRAME EXTENSION PANELS

WALL-MOUNTED

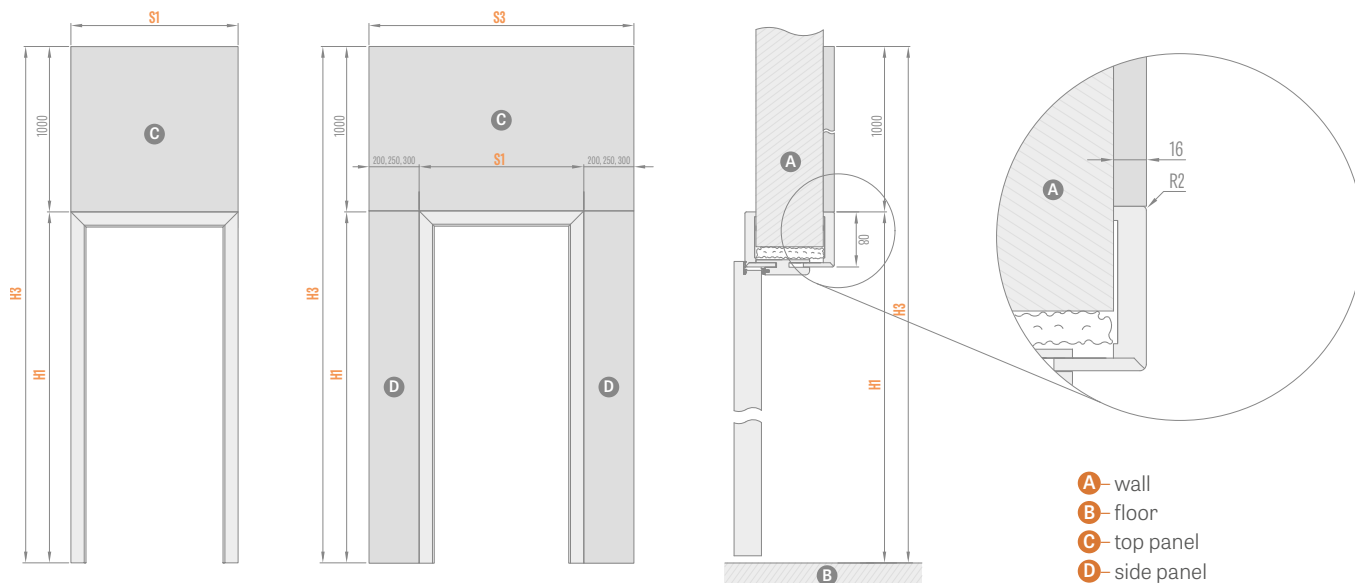

INTERNAL DOORS <sup>1)</sup>				
Frame type	H1	H3	Width	S1
Adjustable door frame rebated	2109	3109	"60"	786
			"70"	886
			"80"	986
			"90"	1086
			"100"	1186
Adjustable door frame NON-REBATED	2122	3122	"60"	811
			"70"	911
			"80"	1011
			"90"	1111
			"100"	1211
REVERSE DOOR FRAME (flush side with the leaf)	2122	3122	"60"	791
			"70"	891
			"80"	991
			"90"	1091
			"100"	1191
REVERSE DOOR FRAME	2144	3144	"60"	834
			"70"	934
			"80"	1034
			"90"	1134
			"100"	1234

TOP PANEL (1000 x S1) <sup>1)</sup>

FRONT DOOR (panels on the staircase side door opening inwards)										
Frame type	H1	H3	Width	S1	S3					
Adjustable door frame HERSE	2109	3109	"80"	986	1186	1236	1286	1386	1486	1586
			"90"	1086	1286	1336	1386	1486	1586	1686
			"100"	1186	1386	1436	1486	1586	1686	1786
			"80N"	1012	1212	1262	1312	1412	1512	1612
Fixed door frame HERSE "clip"	2142	3142	"80"	1052	1252	1302	1352	1452	1552	1652
			"90"	1152	1352	1402	1452	1552	1652	1752
			"100"	1252	1452	1502	1552	1652	1762	1852
Fixed door frame FORTECA "clip"	2147	3147	"80N"	1012	1212	1262	1312	1412	1512	1612
			"80"	1056	1256	1306	1356	1456	1556	1656
			"90"	1156	1356	1406	1456	1556	1656	1756
			"100"	1256	1456	1506	1556	1656	1756	1856
Adjustable fixed frame FORTECA (on the panels side)	2136	3136	"80N"	990	1190	1240	1290	1390	1490	1590
			"80"	1034	1234	1284	1334	1434	1534	1634
			"90"	1134	1334	1384	1434	1534	1634	1734
			"100"	1234	1434	1484	1534	1634	1734	1834
Fixed door frame LEDA, HYPERION "clip"	2147	3147	"80"	1085	1285	1335	1385	1485	1585	1685
			"90"	1185	1385	1435	1485	1585	1685	1785
			"100"	1285	1485	1535	1585	1685	1785	1885
Adjustable fixed frame LEDA, HYPERION (on the panels side)	2136	3136	"80"	1063	1263	1313	1363	1463	1563	1663
			"90"	1163	1363	1413	1463	1563	1663	1763
			"100"	1263	1463	1513	1563	1663	1763	1863

PANEL 200	PANEL 250	PANEL 300	2 x PANEL 200	2 x PANEL 250	2 x PANEL 300
SINGLE-FACE SIDE PANEL			DOUBLE-FACE SIDE PANEL		

<b>DOOR FRAME EXTENSION PANELS <sup>2)</sup></b>
<b>FINISH / GREKO</b>
<b>CPLO,2, ST CPL and PREMIUM</b>
<b>PAINTED</b>

<sup>1)</sup> only top panels are available for interior door frames

<sup>2)</sup> the panels shall be edged on all four edges in a colour similar to that of the panel surface



# SLIDING SYSTEMS

## WALL-MOUNTED

### WALL-MOUNTED SLIDING DOOR SYSTEM:

<b>SINGLE SP1Nz (with bolt keeper)</b>	
<b>SINGLE SP1Nb (w/o bolt keeper)</b>	
<b>DOUBLE SP2N</b>	

Price includes:

Aluminium track with a cover profile and door stop in the colour of the door leaf and length:

- 210 cm for "100" leaves
- 200 cm for "90" leaves
- 180 cm for "80" leaves
- 150 cm for "70" "60" leaves

### Available wall-mounted sliding system sets

- track with a cover profile and door stop with gasket (only SP1Nz & SP1Nb)
- track with a cover profile and tunnel door frame (only for SP2N)
- track with a cover profile and door stop + tunnel door frame (only SP1Nz & SP1Nb)
- track with a cover profile and door stop with gasket + tunnel door frame (only SP1Nz & SP1Nb)

The non-rebated door leaf for wall-mounted sliding system cannot be cut to size.

The cover profile is neither laminated nor paint coated on the inside.

### ADDITIONAL CHARGES

**tunnel type adjustable door frame** for the price of the adjustable door frame

**hook bolt lock with hardware**  
only for the single system

**oval, rectangular or round** pull handle; glossy chrome, brushed chrome, glossy brass, black matt; two pcs. of pull handles per set

**synchronisation**  
simultaneous opening and closing of the door leaves using only one leaf; only for SP2N

**soft closing damper**  
automatic leaf damping during the final closing phase  
only for SP1Nz and SP1Nb

### ROUND, OVAL AND RECTANGULAR PULL HANDLES

glossy chrome, brushed chrome, glossy brass, black matt



### HOOK BOLT KEY LOCKS

glossy chrome, brushed chrome, glossy brass, black matt

Key only in silver



The hook bolt key lock comes with two pull handles to choose



# WALL-MOUNTED SLIDING DOOR SYSTEM

WITH DOOR OPENING HOUSING

SP1Nz or SP1Nb (left, obverse version)

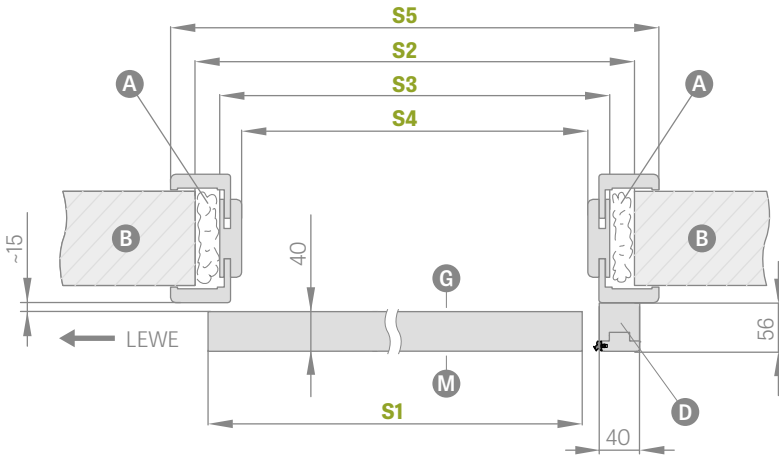

SP2N (obverse version)

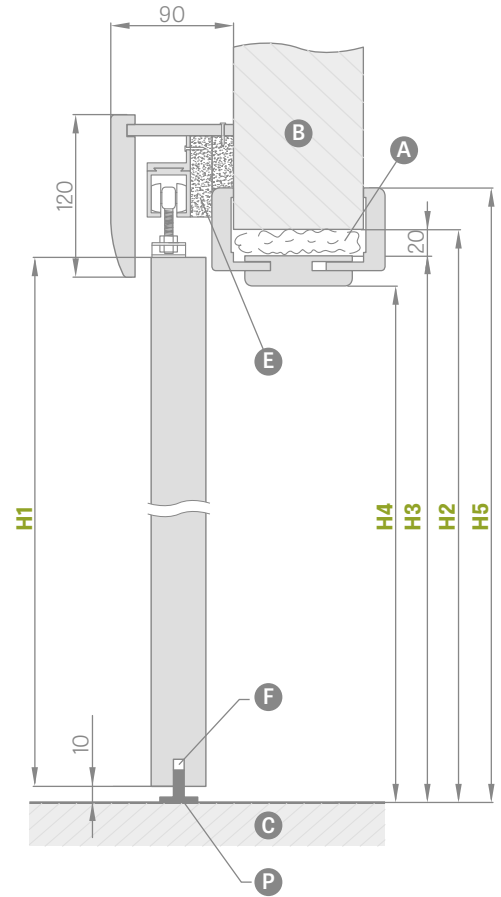
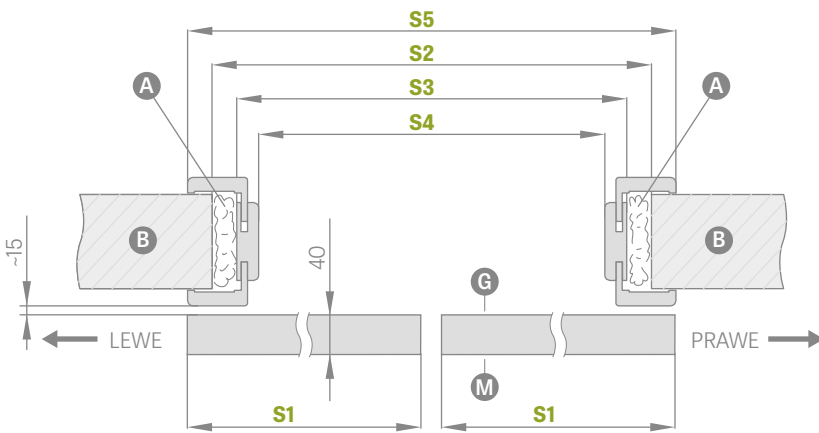

- A**– foam
- C**– floor
- E**– spacer strip
- G**– glass plain side
- M**– glass matt side

- B**– wall
- D**– door stop
- F**– moulding for guide rail
- P**– Floor guide rail

WALL-MOUNTED SLIDING DOOR SYSTEM WITH DOOR OPENING HOUSING

SINGLE-LEAF DOORS

DOUBLE-LEAF DOORS

	SINGLE-LEAF DOORS					DOUBLE-LEAF DOORS				
	"60"	"70"	"80"	"90"	"100"	"60" x2	"70" x2	"80" x2	"90" x2	"100" x2
<b>S1</b> Door leaf width	644	744	844	944	1044	1288	1488	1688	1888	2088
<b>S2</b> Opening width in the wall	688	788	888	988	1088	1288	1488	1688	1888	2088
<b>S3</b> Frame outer width	648	748	848	948	1048	1248	1448	1648	1848	2048
<b>S4</b> Frame opening width	604	704	804	904	1004	1204	1404	1604	1804	2004
<b>S5</b> Frame cover width Architraves 6 cm / Architraves 8cm	746 / 786	846 / 886	946 / 986	1046 / 1086	1146 / 1186	1346 / 1386	1546 / 1586	1746 / 1786	1946 / 1986	2146 / NA
<b>H1</b> Door leaf height	2030	2030	2030	2030	2030	2030	2030	2030	2030	2030
<b>H2</b> Opening height in the wall	2060	2060	2060	2060	2060	2060	2060	2060	2060	2060
<b>H3</b> Frame outer height	2040	2040	2040	2040	2040	2040	2040	2040	2040	2040
<b>H4</b> Frame opening height	2018	2018	2018	2018	2018	2018	2018	2018	2018	2018
<b>H5</b> Frame cover height strip 6 cm / strip 8cm	2089 / 2109	2089 / 2109	2089 / 2109	2089 / 2109	2089 / 2109	2089 / 2109	2089 / 2109	2089 / 2109	2089 / 2109	2089 / NA





# WALL-MOUNTED SLIDING DOOR SYSTEM

## LOFT STANDARD TYPE



Leaf BALDUR 7, laminate WHITE TITAN UV, black rectangular handle, handles INDUSTRIAL

The LOFT STANDARD single sliding system is available with all leaves in the SP1Nb standard wall mounted sliding system.

Double sliding system LOFT STANDARD consists of two single systems and a connecting element for rails.

Double LOFT STANDARD system is counted as 2 x single system + connecting element for rails. Choice of two handles holding the leaf: INDUSTRIAL and RETRO (page 138).

door closer on one side

connector for tracks (enables the use of the LOFT system in the double-leaf system)

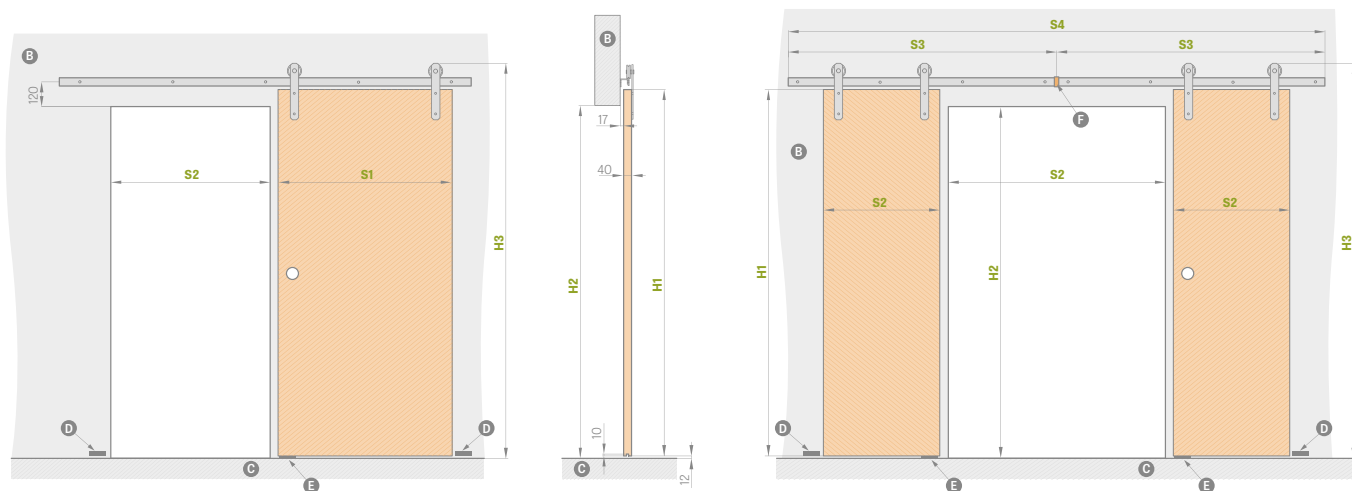

	"60"	"70"	"80"	"90"	"100"
<b>S1</b> Door leaf width	644	744	844	944	1044
<b>S2</b> Opening width in the wall <sup>1)</sup>	574	674	774	874	974
<b>H1</b> Door leaf height	2030	2030	2030	2030	2030
<b>H2</b> Opening height in the wall	1962	1962	1962	1962	1962
<b>H3</b> Overall system height	2170	2170	2170	2170	2170

### GUIDE RAIL FOR SINGLE SYSTEM LENGTH:

- 200 cm for "60" "70" "80" leaves
- 250 cm for "90" "100" leaves

	"120"	"140"	"160"	"180"	"200"
<b>S1</b> Door leaf width	2 x 644	2 x 744	2 x 844	2 x 944	2 x 1044
<b>S2</b> Opening width in the wall <sup>1)</sup>	1202	1402	1602	1802	2002
<b>S3</b> Guide width	1500	1500	2000	2000	2200
<b>S4</b> Total guide width <sup>2)</sup>	3000	3000	4000	4000	4400
<b>H1</b> Door leaf height	2030	2030	2030	2030	2030
<b>H2</b> Opening height in the wall	1962	1962	1962	1962	1962
<b>H3</b> Overall system height	2170	2170	2170	2170	2170

**B** – wall **C** – floor **D** – wall mounted buffer  
**E** – guide **F** – guide connector <sup>2)</sup>

<sup>1)</sup> the leaf in the closed position overlaps 35 mm on each side

<sup>2)</sup> a guide for double-leaf system consists of two guides connected with a connector



# WALL-MOUNTED SLIDING DOOR SYSTEM

LOFT Type

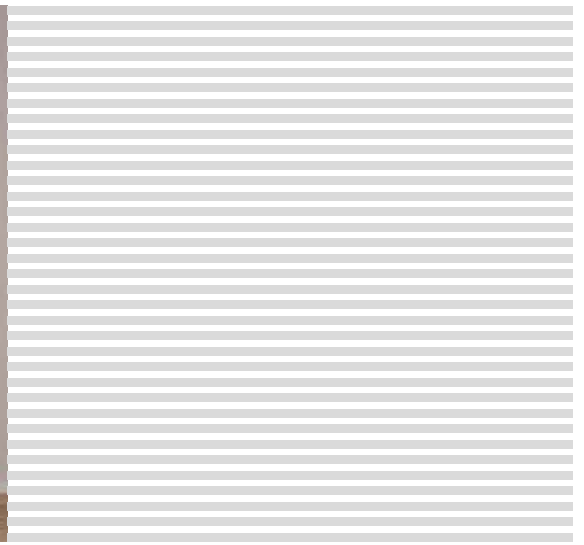

LOFT TILES, laminate OAK ST CPL, round handles, RETRO handles

LOFT Type wall-mounted sliding door system is available in black and comes complete with the LOFT Type plain door leaf. The LOFT door leaf comes with the stabilising "honeycomb" filling as standard or solid core for extra charge. The door leaf features a non-rebated edge. The system is designed for clear finished opening, without a tunnel.

The complete system includes the sliding LOFT system + LOFT door leaf + pull handle + door closer on one or both side(s).

The double LOFT system is counted as 2 x single system + connecting rail element.

Choice of two handles holding the leaf: INDUSTRIAL and RETRO.

## LOFT sliding door system

oval, rectangular or round pull handle

solid core filling

round and square metal ventilation sleeves (4 pieces); black matt

door closer on one side

connector for tracks (enables the use of the LOFT system in the double-leaf system)

black door leaf edge finish

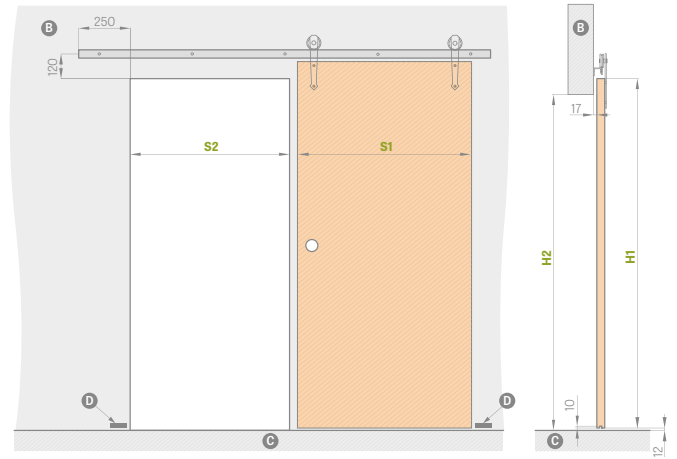

	"60"	"70"	"80"	"90"	"100"
<b>S1</b> Door leaf width	644	744	844	944	1044
<b>S2</b> Opening width in the wall	574	674	774	874	974
<b>H1</b> Door leaf height	2150	2150	2150	2150	2150
<b>H2</b> Opening height in the wall	2082	2082	2082	2082	2082

**B** – wall **C** – floor **D** – wall mounted buffer

## PREMIUM / CPL | CPL 0.2 | WHITE TITANIUM UV PAINT

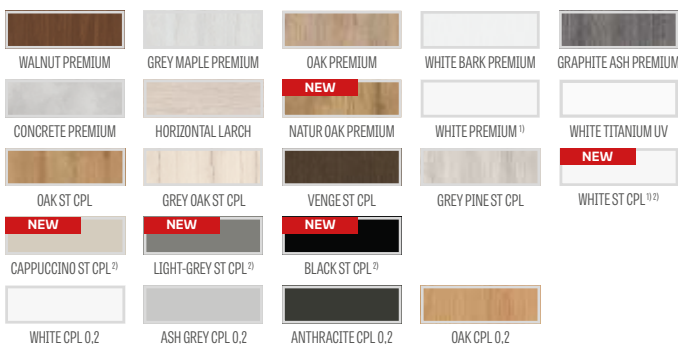

<sup>1)</sup> plain white laminate imitating a painted surface

<sup>2)</sup> special AntiFinger coating to reduce dirt and fingerprints

## ROUND, OVAL, RECTANGULAR PULL HANDLES

glossy chrome, brushed chrome, glossy brass, black matt

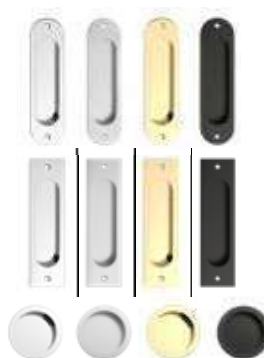

## GUIDE RAIL LENGTHS:

- 200 cm for "60" "70" "80" leaves  
- 250 cm for "90" "100" leaves

## LEAF-HOLDING HANDLES





# WALL-MOUNTED SLIDING DOOR SYSTEM

## MAGIC Type



MAGIC LEAF, laminate OAK PREMIUM, oval pull handle

MAGIC Type wall-mounted sliding door system is available complete with the MAGIC Type plain door leaf only. The MAGIC door leaf comes with the stabilising "honeycomb" filling as standard or solid core for extra charge. The door leaf features a non-rebated edge. The system is designed for clear finished opening, without a tunnel.

The complete system includes the sliding MAGIC system + MAGIC door leaf + pull handle. The system is only available as a complete set (system + leaf).

### MAGIC SLIDING DOOR SYSTEM

oval, rectangular or round pull handle

solid core filling

round and square metal sleeves (4 pcs);  
glossy chrome, brushed chrome, black matt

black door leaf edge finish

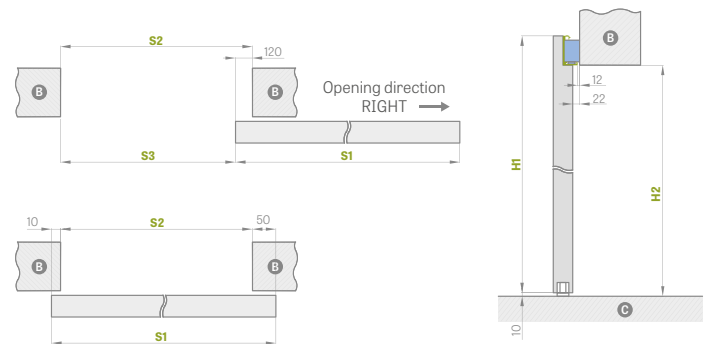

### MAGIC WALL-MOUNTED SLIDING DOOR SYSTEM

		"60"	"70"	"80"	"90"	"100"
<b>S1</b>	Door leaf width	644	744	844	944	1044
<b>S2</b>	Opening width in the wall	584	684	784	884	984
<b>S3</b>	Transition light	464	564	664	764	864
<b>H1</b>	Door leaf height	2150	2150	2150	2150	2150
<b>H2</b>	Opening height in the wall	2100	2100	2100	2100	2100

**B** – wall **C** – floor

### MAGIC DOOR LEAF

PREMIUM / CPL	CPL 0.2	WHITE TITANIUM UV PAINT
---------------	---------	-------------------------

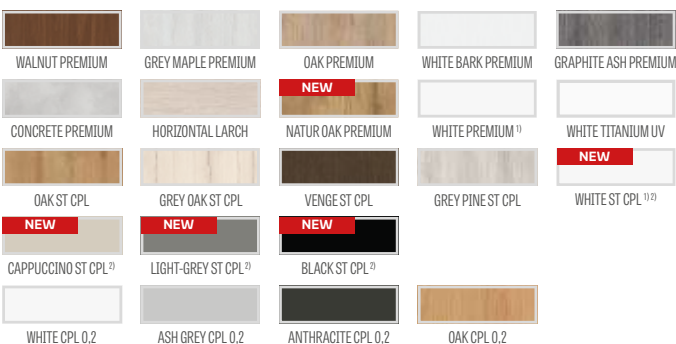

<sup>1)</sup> plain white laminate imitating a painted surface

<sup>2)</sup> special AntiFinger coating to reduce dirt and fingerprints

### ROUND, OVAL, RECTANGULAR PULL HANDLES

glossy chrome, brushed chrome, glossy brass, black matt



**NEW**

BLACK PLAIN DOOR LEAF EDGE FINISH

**NEW**

BLACK HORIZONTAL DOOR LEAF EDGE FINISH



# WALL-MOUNTED SLIDING DOOR SYSTEM

GRAF GLASS DOORS



GRAF 38 SYSTEM

Sliding system for glass doors with a silver anodised aluminium or black matt powder-painted cover.

This system is complete and designed for fitting in a clear finished opening, as the tunnel is not available. The system range includes all GRAF glass panes, see p. 58/-59 and go to our website: [www.erkado.pl](http://www.erkado.pl) and the B2B panel.

The complete system includes: sliding SYSTEM GRAF + glass pane SYSTEM GRAF + pull handle + door closer on one side

## GLASS DOOR SLIDING SYSTEM

- silver anode

- black matt **NEW**

double-sided round pull handle, stainless steel

double-sided round pull handle, stainless steel, black matt

"90" glass pane extra charge

closer

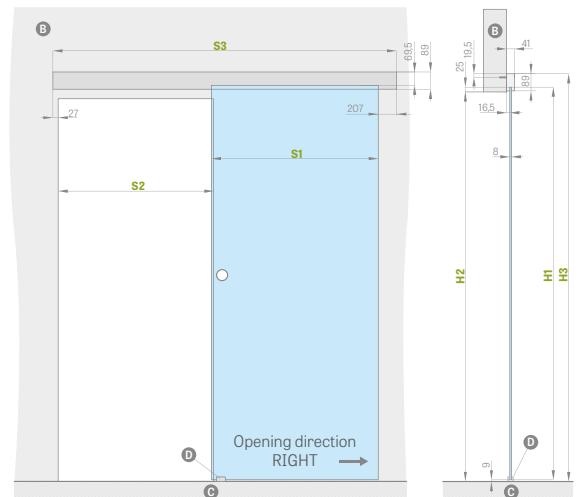

## WALL-MOUNTED GLASS DOOR SLIDING SYSTEM

	"60"	"70"	"80"	"90"
<b>S1</b> Door leaf width	662	762	862	962
<b>S2</b> Opening width in the wall	602	702	802	902
<b>S3</b> Guide rail length	1500	1500	1800	2000
<b>H1</b> Door leaf height	2036			
<b>H2</b> Opening height in the wall	max 2020			
<b>H3</b> Overall system height	2114			

## PULL HANDLE

stainless steel, matt black



**NEW**

**B** - wall **C** - floor **D** - guide shoe



# SLIDING SYSTEMS

## POCKET SYSTEMS

ERKADO pocket door system range includes:

BASIC TUNNEL INSTALLATION		
SP1C.100		Single "100" pocket sliding system Only available for STILE doors, painted doors and ALTAMURA 1, UNO PREMIUM and UNO LUX models
SP2C.100		Double "100" pocket sliding system Only available for STILE doors and ALTAMURA 1, UNO PREMIUM and UNO LUX models
SP1C.125		Single "125" pocket sliding system
SP2C.125		Double "125" pocket sliding system
ZN1		One-sided supplementary basic in-wall installation for SP1C.100 or SP1C.125 system
ZN2		One-sided supplementary basic in-wall installation for SP2C.100 or SP2C.125 system

Not available for CPL0.2 & CPL0.7 laminates

$$\text{SLIDING SYSTEM PRICE} = \text{DOOR LEAF PRICE} + \text{ALUMINIUM POCKET PRICE} + \text{BASIC TUNNEL INSTALLATION PRICE} + \text{OPTIONAL INSTALLATION PRICE ZN1 OR ZN2}$$

### Standard single/double pocket sliding system includes:

- aluminium case [LEON] SP1
- aluminium case [LEON] SP2
- non-rebated door leaf / two non-rebated door leaves – price for standard door leaf / price for two door leaves
- basic tunnel installation (see table above)
- tunnel installation ZN1 or ZN 2 – see table on the next page

### ROUND, OVAL AND RECTANGULAR PULL HANDLES

glossy chrome, brushed chrome, glossy brass, black matt



### HOOK BOLT KEY LOCKS

glossy chrome, brushed chrome, glossy brass, black matt



Key only in silver

The hook bolt key lock comes with two pull handles to choose

### ADDITIONAL CHARGES

frame joints at 90 degrees

#### hook bolt lock with hardware

only available for: SP1C.100, SP1C.125

#### oval, rectangular or round pull handle

glossy chrome, brushed chrome, glossy brass, black matt

Available for SP1C.100, SP2C.100, SP1C.125, SP2C.125

Pull handle set includes two pcs.

#### finger pull

glossy chrome, brushed chrome, glossy brass, black matt

#### synchronisation

simultaneous opening and closing of the door leaves using only one leaf

only available for: SP2C.100, SP2C.125

#### Soft closing damper

automatic soft close in the final closing phase; available for SP1C.100, SP1C.125 only

One-sided adjustment range for the basic wall  
min-max (mm)

0-40; 40-60; 60-80;
80-100; 100-120; 120-140
140-160; 160-180; 180-200
200-220; 220-240
240-260; 260-280
280-300; 300-320
320-340; 340-360

- The system of one-sided in-wall installation for double doors ZN2 + 30% extra of the prices in table above

SINGLE SLIDING SYSTEMS AND DOUBLE POCKET SYSTEMS

		"60"	"70"	"80"	"90"	"100"	2 x "60"	2 x "70"	2 x "80"	2 x "90"	2 x "100"
<b>S1</b>	Door width	644	744	844	944	1044	1288	1488	1688	1888	2088
<b>S2</b>	Frame opening width	602	702	802	902	1002	1202	1402	1602	1802	2002
<b>S3</b>	Pocket width	1318	1518	1718	1918	2118	2538	2938	3338	3738	4138
<b>S4</b>	Frame cover width Architraves 6cm / Architraves 8cm	744 / 784	844 / 884	944 / 984	1044 / 1084	1144 / 1184	1344 / 1384	1544 / 1584	1744 / 1784	1944 / 1984	2144 / NA
<b>S5</b>	Opening width in the pocket	655	755	855	955	1055	1255	1455	1655	1855	2055
<b>S6</b>	Opening width in the wall	1338	1538	1738	1938	2138	2558	2958	3358	3758	4158
<b>H1</b>	Door height	2030	2030	2030	2030	2030	2030	2030	2030	2030	2030
<b>H2</b>	Frame cover height Architraves 6cm / Architraves 8cm	2092 / 2112	2092 / 2112	2092 / 2112	2092 / 2112	2092 / 2112	2092 / 2112	2092 / 2112	2092 / 2112	2092 / 2112	2092 / NA
<b>H3</b>	Pocket height	2115	2115	2115	2115	2115	2115	2115	2115	2115	2115
<b>H4</b>	Frame opening height	2021	2021	2021	2021	2021	2021	2021	2021	2021	2021
<b>H5</b>	Opening height in the wall	2125	2125	2125	2125	2125	2125	2125	2125	2125	2115



Photo: Wall-mounted sliding system



Photo: Pocket sliding system



# SINGLE AND DOUBLE SYSTEMS

## POCKET SYSTEMS

### SP1C.100 (left, AWERS obverse glazing)

#### Fixed range of 100 mm

Pocket thickness before gypsum board installation – 75 mm

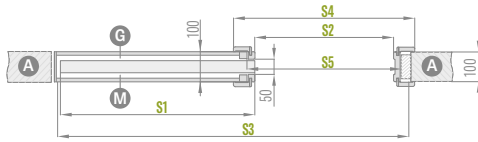

For UNO PREMIUM, UNO LUX, ALTAMURA 1 only, and for all stile door leaves. The system does not come with dust brushes (not required).

### SP1C.125 (left, AWERS obverse glazing)

#### Fixed range of 125 mm

Pocket thickness before gypsum board installation – 100 mm

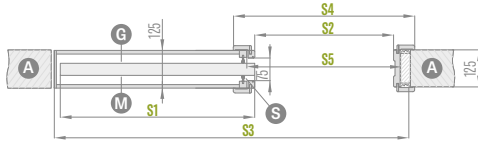

Only for use with panel door leaves which are supplied with a glass frame. The system includes gray dust brushes.

### ZN1 one-sided basic in-wall installation for SP1C.100 and SP1C.125

#### Basic in-wall installation range from 0-40; 40-60; ... 340-360

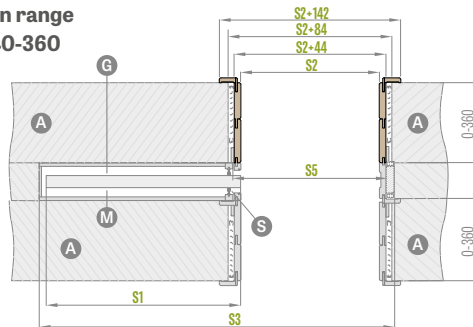

The drawing shows the basic in-wall installation ZN1 + ZN1.

### SP2C.125 (AWERS obverse glazing)

#### Fixed range of 125 mm

Pocket thickness before gypsum board installation – 100 mm



Only for use with panel door leaves which are supplied with a glass frame. The system includes gray dust brushes.

### SP2C.100 (AWERS obverse glazing)

#### Fixed range of 100 mm

Pocket thickness before gypsum board installation – 75 mm



For UNO PREMIUM, UNO LUX, ALTAMURA 1 only, and for all stile door leaves. The system does not come with dust brushes (not required).

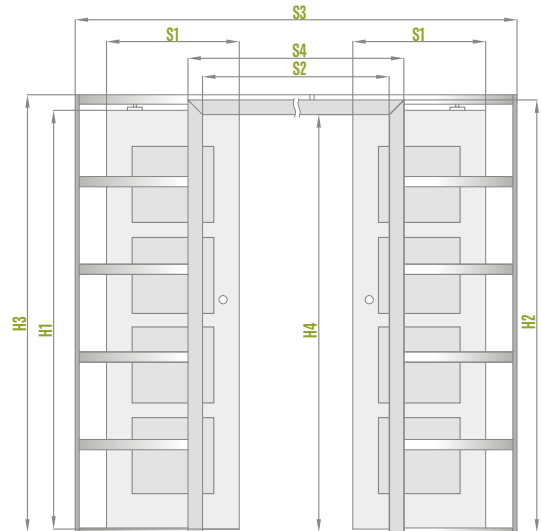
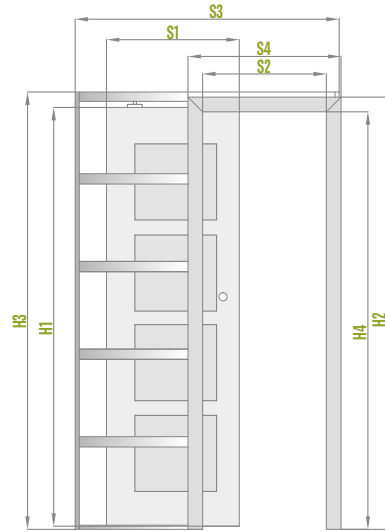

- A** – wall
- G** – glass plain side
- M** – glass matt side

- I** – gypsum board
- S** – dust brushes

### ZN2 one-sided basic in-wall installation for SP2C.100 and SP2C.125

#### Basic in-wall installation range from 0-40; 40-60; ... 340-360

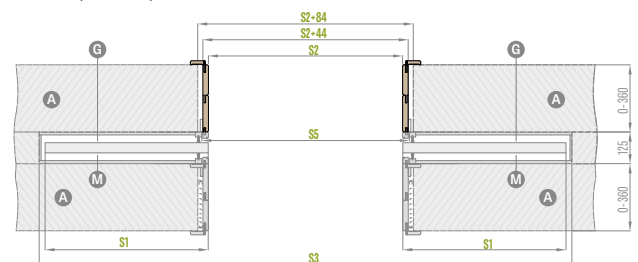

The drawing shows the basic in-wall installation ZN2 + ZN2.



# DOUBLE-LEAF DOORS

## REBATED AND NON-REBATED

### USEFUL INFORMATION

#### DOUBLE-LEAF DOORS



- The double-leaf doors are supplied with a solid core filling for extra charge.
- The double-leaf doors are made according to available models of the flush single leaf doors, STILE doors with respective features: colour, finish (STANDARD, SOFT), glazing etc.
- Double-leaf doors available in CPL 0.2 & CPL 0.7
- Passive doors use pull latches.
- Under "60" width passive door available in the full plain version only – side panel (see drawing below).
- Side panels are made in the STANDARD edge flush technology. Available with the "honeycomb" filling as standard or solid core for extra charge. Grain direction of the side panels is vertical.
- Both active and inactive door leaves come with lippings.
- Lippings in CPL 0.7 door leaves are laminated with CPL 0.2
- The double-leaf doors in non-rebated technology is available with a magnetic lock only.
- Double non-rebated leaf doors come with an adjustable door frame only.
- Electric door strike is not available for the double-leaf doors.

### AVAILABLE DOOR LEAF WIDTHS

- Panel and stile DOUBLE-LEAF DOORS from "120" to "190"\*\*\* and mixes with full plain side panels

60 + 30*	70 + 30*	80 + 30*	90 + 30*	100 + 30*
60 + 40*	70 + 40*	80 + 40*	90 + 40*	100 + 40*
60 + 50*	70 + 50*	80 + 50*	90 + 50*	100 + 50*

- \* Side panel available in standard technology only as a full plain version
- \*\* For "180" non-rebated doors

### DOUBLE-LEAF DOOR PRICE:

- Panel and stile:

active leaf **60 70 80 90 100** + passive leaf **60 70 80 90\***

$$\text{Price of double-leaf doors with lipping} = \text{Door leaf price x 2} + \text{Lippings}$$

- Panel and stile:

active leaf **60 70 80 90 100** + full, plain passive side panels **30 40 50**

$$\text{Price of double-leaf doors with side panel and lipping} = \text{Door leaf price} + \text{Full side panel with lippings}$$

- Prices of fixed and adjustable door frames for double-leaf doors + 30%

\* not in the non-rebated door leaves





# DOUBLE-LEAF DOORS

NON-REBATED

NON-REBATED DOUBLE-LEAF DOORS  
WITH ADJUSTABLE DOOR FRAME

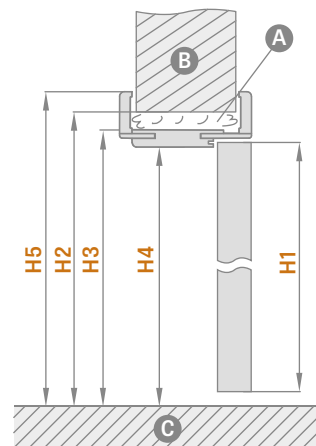
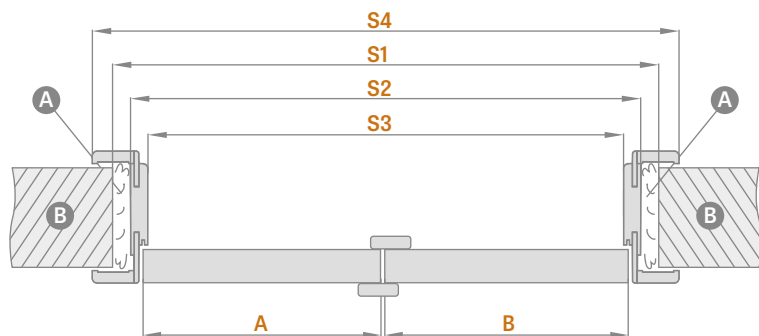

A - foam B - wall C - floor

Adjustable door frame		NON-REBATED DOUBLE-LEAF DOORS									
		"90"	"100"	"110"	"120"	"130"	"140"	"150"	"160"	"170"	"180"
<b>A+B</b>	Door leaf width	988	1088	1188	1288	1388	1488	1588	1688	1788	1888
<b>S1</b>	Opening width in the wall	1061	1161	1261	1361	1461	1561	1661	1761	1861	1961
<b>S2</b>	Frame outer width	1021	1121	1221	1321	1421	1521	1621	1721	1821	1921
<b>S3</b>	Frame opening width	977	1077	1177	1277	1377	1477	1577	1677	1777	1877
<b>S4</b>	Frame cover width Strip 6 cm / Strip 8 cm	1119 / 1159	1219 / 1259	1319 / 1359	1419 / 1459	1519 / 1559	1619 / 1659	1719 / 1759	1819 / 1859	1919 / 1959	2019 / 2059
<b>H1</b>	Door leaf height	2030	2030	2030	2030	2030	2030	2030	2030	2030	2030
<b>H2</b>	Opening height in the wall	2073	2073	2073	2073	2073	2073	2073	2073	2073	2073
<b>H3</b>	Frame outer height	2053	2053	2053	2053	2053	2053	2053	2053	2053	2053
<b>H4</b>	Frame opening height	2031	2031	2031	2031	2031	2031	2031	2031	2031	2031
<b>H5</b>	Frame cover height Strip 6 cm / Strip 8 cm	2102 / 2122	2102 / 2122	2102 / 2122	2102 / 2122	2102 / 2122	2102 / 2122	2102 / 2122	2102 / 2122	2102 / 2122	2102 / 2122

DOUBLE-LEAF DOORS  
- SYMMETRIC



DOUBLE-LEAF DOORS  
- ASYMMETRIC



DOUBLE-LEAF DOORS  
- WITH PLAIN SIDE PANEL





# DOUBLE-LEAF DOORS

## REBATED

### REBATED DOUBLE-LEAF DOORS WITH ADJUSTABLE DOOR FRAME

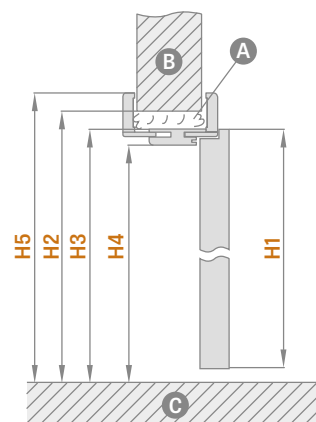
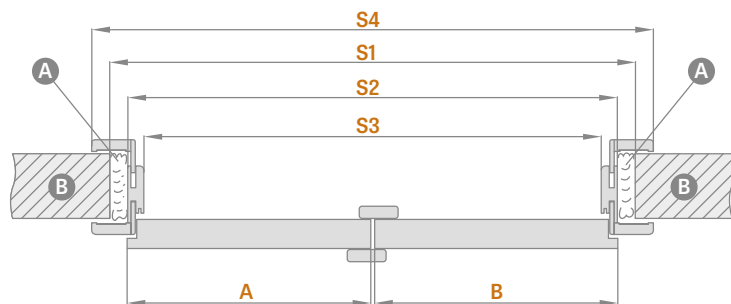

A - foam B - wall C - floor

Adjustable door frame	DOUBLE-LEAF DOORS											
	"90"	"100"	"110"	"120"	"130"	"140"	"150"	"160"	"170"	"180"	"190"	
A+B	Door leaf width	988	1088	1188	1288	1388	1488	1588	1688	1788	1888	1988
S1	Opening width in the wall	1034	1134	1234	1334	1434	1534	1634	1734	1834	1934	2034
S2	Frame outer width	994	1094	1194	1294	1394	1494	1594	1694	1794	1894	1994
S3	Frame opening width	950	1050	1150	1250	1350	1450	1550	1650	1750	1850	1950
S4	Frame cover width Architraves 6 cm / Architraves 8 cm	1092 / 1132	1192 / 1232	1292 / 1332	1392 / 1432	1492 / 1532	1592 / 1632	1692 / 1732	1792 / 1832	1892 / 1932	1992 / 2032	2092 / 2132
H1	Door leaf height	2030	2030	2030	2030	2030	2030	2030	2030	2030	2030	2030
H2	Opening height in the wall	2060	2060	2060	2060	2060	2060	2060	2060	2060	2060	2060
H3	Frame outer height	2040	2040	2040	2040	2040	2040	2040	2040	2040	2040	2040
H4	Frame opening height	2018	2018	2018	2018	2018	2018	2018	2018	2018	2018	2018
H5	Frame cover height Strip 6 cm / Strip 8 cm	2089 / 2109	2089 / 2109	2089 / 2109	2089 / 2109	2089 / 2109	2089 / 2109	2089 / 2109	2089 / 2109	2089 / 2109	2089 / 2109	2089 / 2109

### REBATED DOUBLE-LEAF DOORS WITH FIXED DOOR FRAME

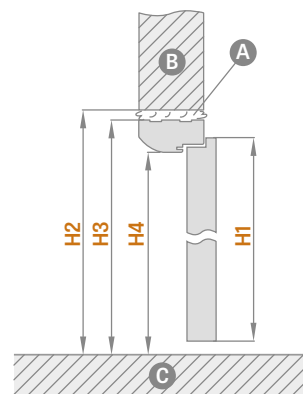
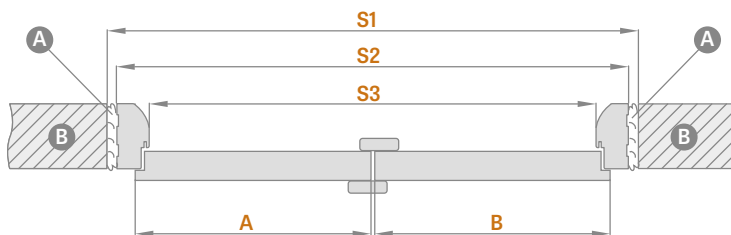

A - foam B - wall C - floor

Fixed door frame	DOUBLE-LEAF DOORS											
	"90"	"100"	"110"	"120"	"130"	"140"	"150"	"160"	"170"	"180"	"190"	
A+B	Door leaf width	988	1088	1188	1288	1388	1488	1588	1688	1788	1888	1988
S1	Opening width in the wall	1068	1168	1268	1368	1468	1568	1668	1768	1868	1968	2068
S2	Frame outer width	1038	1138	1238	1338	1438	1538	1638	1738	1838	1938	2038
S3	Frame opening width	950	1050	1150	1250	1350	1450	1550	1650	1750	1850	1950
H1	Door leaf height	2030	2030	2030	2030	2030	2030	2030	2030	2030	2030	2030
H2	Opening height in the wall	2077	2077	2077	2077	2077	2077	2077	2077	2077	2077	2077
H3	Frame outer height	2062	2062	2062	2062	2062	2062	2062	2062	2062	2062	2062
H4	Frame opening height	2018	2018	2018	2018	2018	2018	2018	2018	2018	2018	2018



# FOLDING DOORS



## FOLDING DOOR LEAF

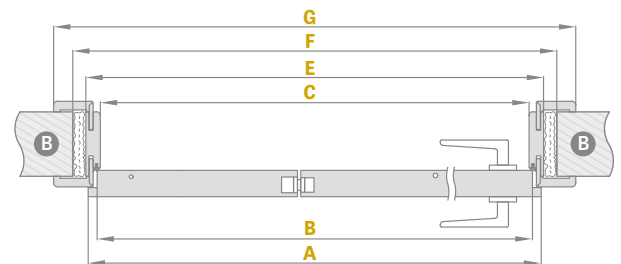
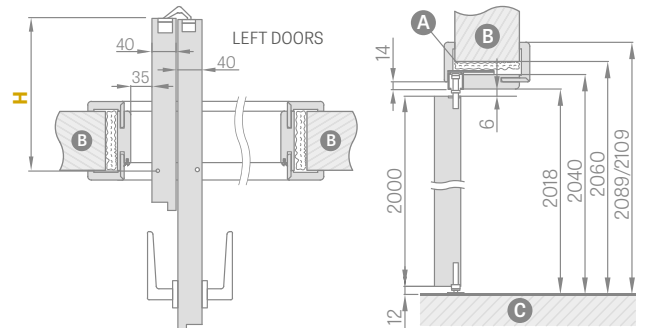

Door width	A	B	C	E	F	G	H
"60"	641	614	604	648	688	746*/786**	152.5
"70"	741	714	704	748	788	846*/886**	202.5
"80"	841	814	804	848	888	946*/986**	252.5
"90"	941	914	904	948	988	1046*/1086**	302.5
"100"	1041	1014	1004	1048	1088	1146*/1186**	352.5

\* Architraves 6 cm / \*\* Architraves 8 cm; joints at 45 degrees only

### CONSTRUCTION

- the door leaf is composed of two parts joined with concealed hinges
- MDF stile covered with two HDF boards or internal timber stile covered with two HDF boards for PREMIUM and CPL laminates
- honeycomb stabilising filling or solid core filling against an additional charge

### FINISHING

- laminated HDF board
- STANDARD leaf edge
- the edge laminated in the same colour as the door leaf or, optionally, plain black edging **NEW** (transverse larch, black edge with a transverse structure)

### HARDWARE

- three concealed hinges between leaves
- concealed guiding system in the top and bottom door sections
- A deadbolt lock, euro profile cylinder, economy lock or with a thumb turn

### ADDITIONAL CHARGES

solid core filling

"100" door leaf

black door leaf edge finish **NEW**

### AVAILABLE DOOR LEAF WIDTHS

- 60
- 70
- 80
- 90
- 100



Installation vide  
<https://youtu.be/tzccmzy7rv9>

STANDARD				
WALNUT FINISH	LIGHT ACACIA FINISH	ACACIA FINISH	WHITE GREKO 1)	SNOW-WHITE GREKO 1)
GREKO WALNUT	SANREMO GREKO	GREKO SONOMA	MEDIUM GREKO OAK	GREKO ELM
GOLDEN GREKO OAK	GREKO GREY OAK	GREKO WHITE PINE	GREKO OAK	
WALNUT PREMIUM	GREY MAPLE PREMIUM	OAK PREMIUM	WHITE BARK PREMIUM	GRAPHITE ASH PREMIUM
CONCRETE PREMIUM	HORIZONTAL LARCH	NATUR OAK PREMIUM	WHITE PREMIUM 1)	
OAK ST CPL	GREY OAK ST CPL	VENGE ST CPL	GREY PINE ST CPL	WHITE ST CPL 1) 2)
CAPPUCCINO ST CPL 2)	LIGHT-GREY ST CPL 2)	BLACK ST CPL 2)		

1) plain white laminate imitating a painted surface

2) special AntiFinger coating to reduce dirt and fingerprints

Adjustment range min-max (mm)
80-100
100-120
120-140
140-160
160-180
180-200
200-220
220-240
240-260

Adjustment range min-max (mm)
260-280
260-300
280-300
300-320
320-340
340-360
360-380
380-400
400-420



# COVERT CONCEALED DOOR SYSTEM

OPENING INWARDS AND OUTWARDS



REBATED AND NON-REBATED DOOR LEAF

ALUMINIUM CONCEALED DOOR FRAME

## CONSTRUCTION

- rebated or non-rebated door leaf
- wooden stile covered with two HDF boards
- honeycomb stabilising filling or solid core filling against an additional charge

## FINISHING

- HDF board covered with PREMIUM laminate, UV paint or a laminate designed for subsequent paint coating or wallpapering
- door leaf edge made in rebated or non-rebated technology

## HARDWARE

- required two mortise hinges in the door frame
- magnetic lock in the rebated and non-rebated leaf: with a key, thumb turn cylinder, economy or with a blockade

## ADDITIONAL CHARGES

white door frame <sup>3)</sup>

painted door leaf; WHITE TITANIUM UV

solid core filling

additional bottom bar (can be cut by customer up to max 8 cm)

round and square metal sleeves (4 pcs);  
Finish: brushed nickel, patina, white and black

plastic woodgrain sleeves (4 pcs)

ventilation door cut or grille

"100" door leaf

drop-down gasket <sup>4)</sup>

magnetic stop (buffer) <sup>4)</sup> **NEW**  
(available in six colours p. 132)



WALNUT  
PREMIUM



GREY MAPLE  
PREMIUM



OAK  
PREMIUM

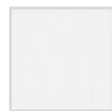

WHITE BARK  
PREMIUM



GRAPHITE ASH  
PREMIUM



CONCRETE  
PREMIUM



HORIZONTAL  
LARCH



NATUR OAK  
PREMIUM

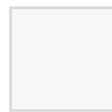

WHITE PREMIUM <sup>1)</sup>



WHITE  
PRIMER <sup>2)</sup>



WHITE TITANIUM  
UV

## AVAILABLE DOOR LEAF WIDTHS

60 70 80 90 100

<sup>1)</sup> plain white laminate imitating a painted surface

<sup>2)</sup> used for wallpaper hanging and painting

<sup>3)</sup> aluminium colour frame as standard

<sup>4)</sup> the stop prevents application of a drop-down gasket and vice versa



# COVERT CONCEALED DOOR SYSTEM

## INWARDS OPENING REBATED DOOR LEAF

### REBATED DOOR LEAF

### ALUMINIUM CONCEALED DOOR FRAME

#### STANDARD DIMENSIONS FOR INWARDS OPENING REBATED DOOR LEAVES

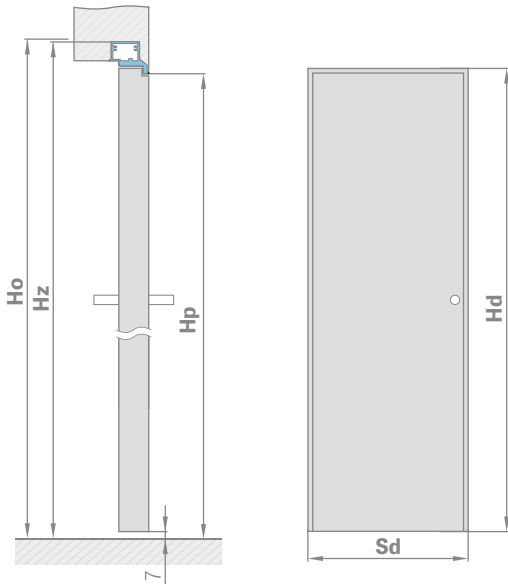

Door leaf width	Construction opening width	Frame outer width	Clear opening width
$S_d$ [mm]	$S_o$ [mm]	$S_z$ [mm]	$S_p$ [mm]
620	700	690	605
720	800	790	705
820	900	890	805
920	1000	990	905
1020	1100	1090	1005

Door leaf height	Construction opening height	Frame outer height	Clear opening height
$H_d$ [mm]	$H_o$ [mm]	$H_z$ [mm]	$H_p$ [mm]
2030	2079	2072	2030

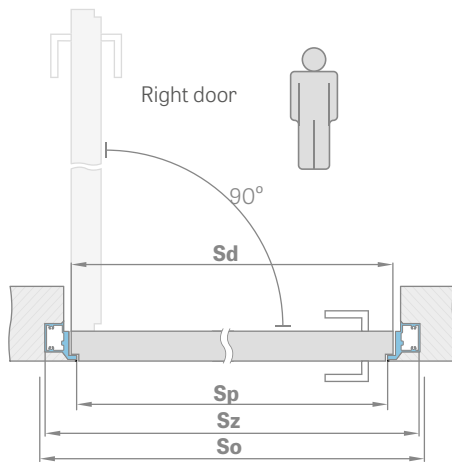

#### GYPSUM BOARD INSTALLATION

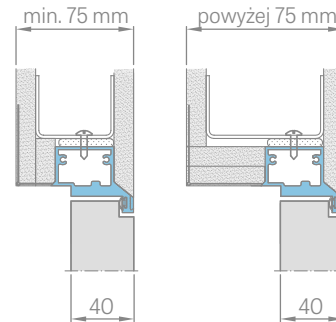

#### ALUMINIUM DOOR FRAME CROSS-SECTION

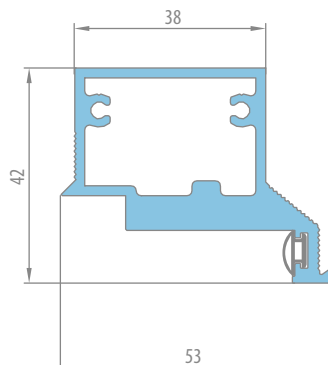

#### ENCLOSED IN WALL

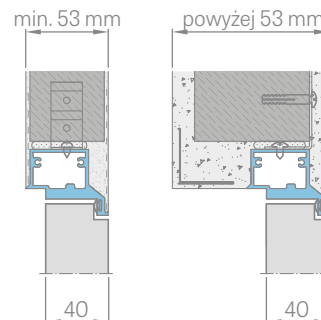



# COVERT CONCEALED DOOR SYSTEM

## OUTWARDS OPENING NON-REBATED DOOR LEAF

### NON-REBATED DOOR LEAF

### ALUMINIUM CONCEALED DOOR FRAME

#### STANDARD DIMENSIONS FOR OUTWARDS OPENING NON-REBATED DOOR LEAVES

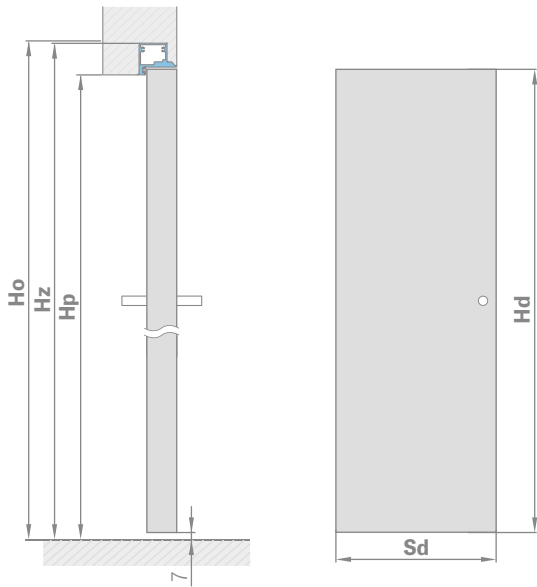

Door leaf width	Construction opening width	Frame outer width	Clear opening width
Sd [mm]	So [mm]	Sz [mm]	Sp [mm]
620	700	690	605
720	800	790	705
820	900	890	805
920	1000	990	905
1020	1100	1090	1005

Door leaf height	Construction opening height	Frame outer height	Clear opening height
Hd [mm]	Ho [mm]	Hz [mm]	Hp [mm]
2020	2069	2062	2020

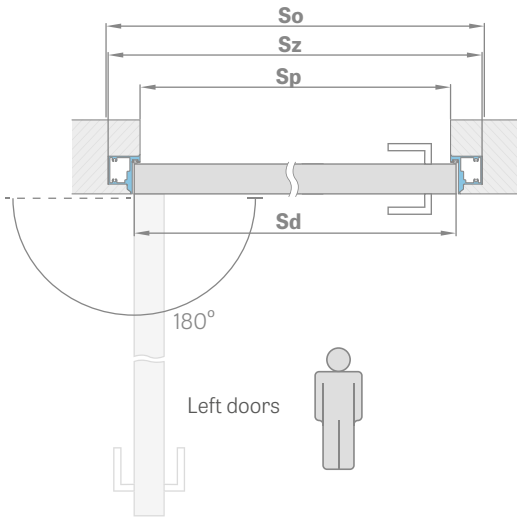

#### GYPSUM BOARD INSTALLATION

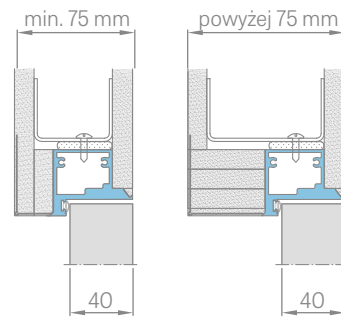

#### ALUMINIUM DOOR FRAME CROSS-SECTION

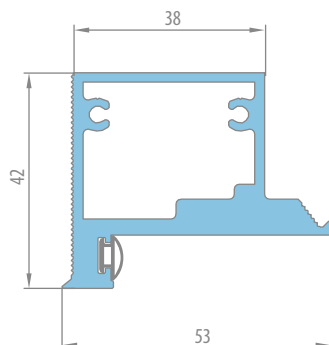

#### ENCLOSED IN WALL

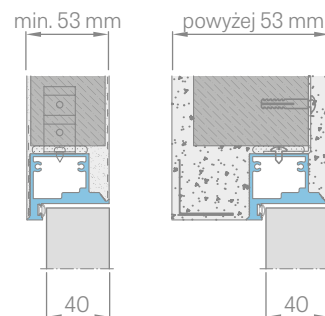



# LIGHTING

## REBATED

### GENERAL INFORMATION

The top and side lights are preassembled and glazed with the VSG 331 safety glass in a frosted or transparent variant. (Please state your choice of glass when placing orders)

### AVAILABLE PRODUCT PACKAGES

SINGLE LEAF DOORS with top, side and corner lights

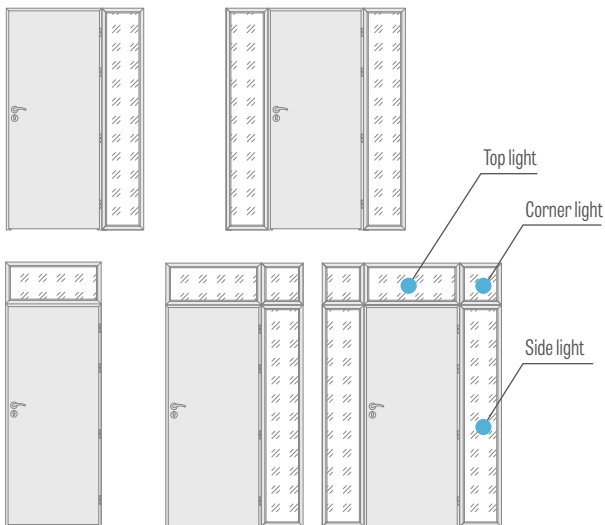

DOUBLE-LEAF DOORS with top, side and corner lights

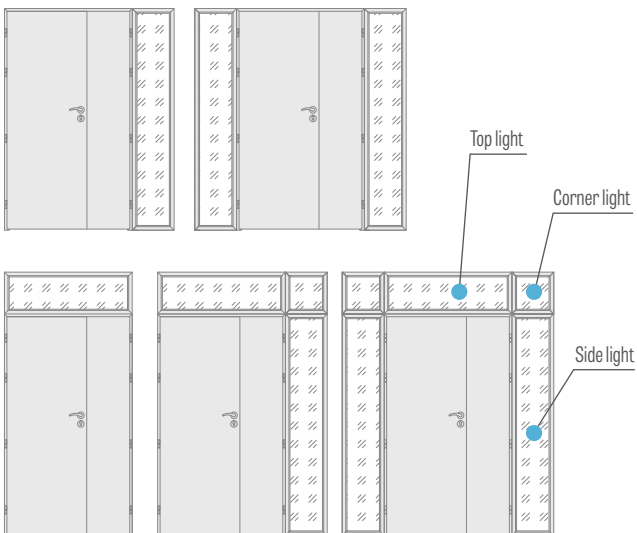

### LIGHTING CATEGORIES

FOR FIXED DOOR FRAMES

FOR ADJUSTABLE DOOR FRAMES

FOR SINGLE LEAF DOORS

FOR DOUBLE-LEAF DOORS

\*\* Ranges available as for the standard adjustable rebated door frames, see p. -163

- The matt VSG 331 or transparent VSG 331 safety glass is included and the price is the same for all laminates and ranges for rebated door frames.
- Prices apply to lights fitted on 6 and 8 cm architraves.
- To paint coated lights + 50% charge applies **NEW**
- Fitting strips for lights are fixed with headless pins which are seen as small dark spots once nailed (especially in white laminates and paint coated lights).
- Lighting not available in CPL 0.2 and CPL 0.7 laminates

Side lights for adjustable door frame strip 6cm /strip 8cm

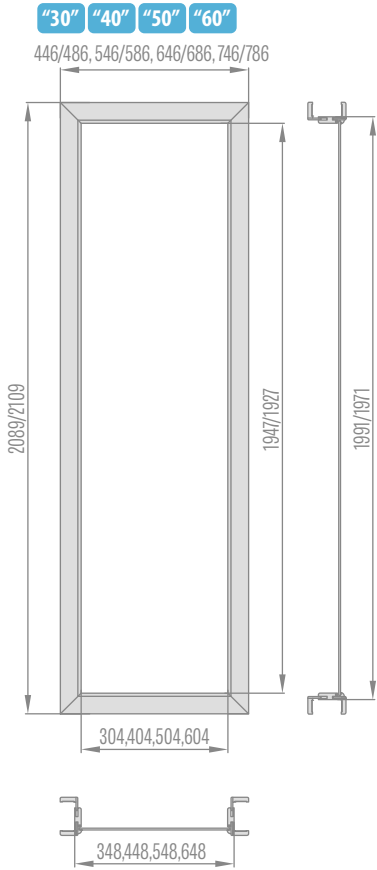

Corner lights for adjustable door frame strip 6cm /strip 8cm

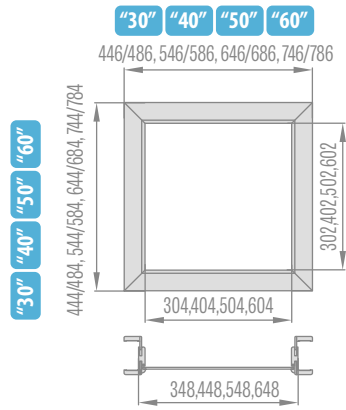

Top lights for adjustable door frame in single leaf doors strip 6cm /strips 6 cm /Strips 8 cm 8cm

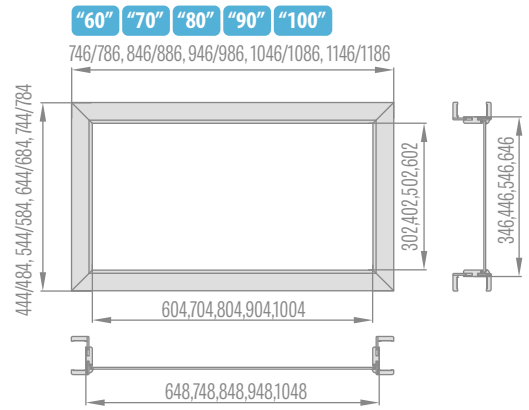

Top lights for adjustable door frame in double-leaf doors strip 6cm /strip 8cm

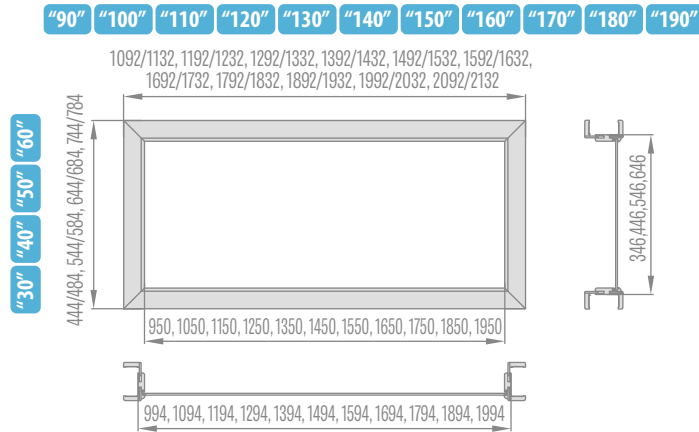

Side lights for fixed door frame

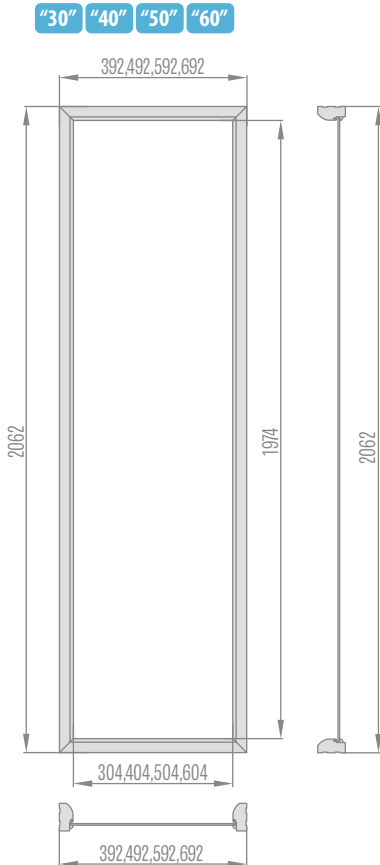

Corner lights for fixed door frame

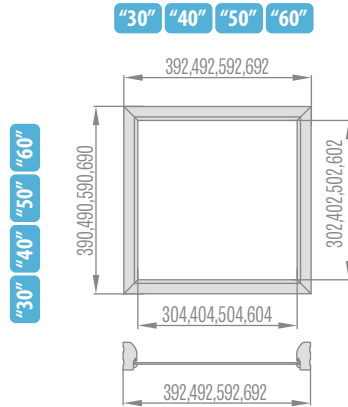

Top lights for fixed door frame in single leaf doors

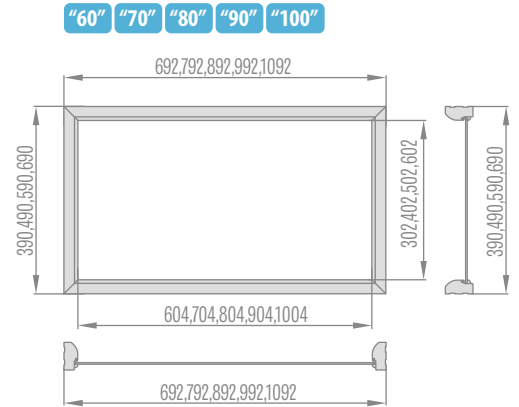

Top lights for fixed door frame in double-leaf doors

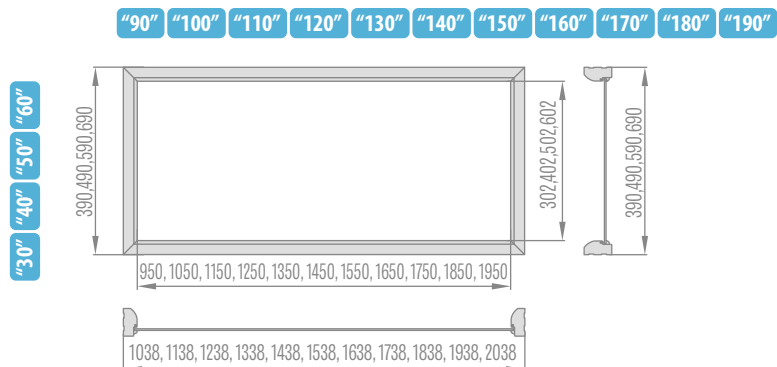



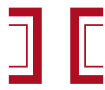

# DOOR FRAMES

- The adjustable and fixed rebated door frames can be used for all types of ERKADO internal doors made in both flush and STILE technologies.
- The adjustable non-rebated door frames can be used for internal doors made in both flush and STILE technologies. These door frames are supplied with three concealed hinges.
- The door frame is made with high quality MDF board and covered with durable wood grain film or coated with durable UV paint.
- Depending on the technology, the door frames are laminated with: FINISH, GREKO, CPL, PREMIUM and UV paint.
- The frames for STILE doors have a third hinge as standard.
- Each adjustable and fixed frame comes complete with disassembled frame components, hinges and screws. The components are supplied with pre-drilled holes for fixing.
- Each set is enclosed with assembly manual and warranty certificate.
- The fixed door frame for Herse collection is rectangular and its core is made of glulam timber.

**ADJUSTABLE DOOR FRAME  
REBATED DOOR LEAVES**



**ADJUSTABLE OVERLAY DOOR FRAME  
FOR STEEL DOOR FRAMES**



**ADJUSTABLE DOOR FRAME  
NON-REBATED DOOR LEAVES**



**STAND FIXED DOOR FRAME  
REBATED DOOR LEAVES**



**STANDARD SQUARE FOR ADJUSTABLE  
DOOR FRAME**

Strip 6 cm / Strip 8 cm

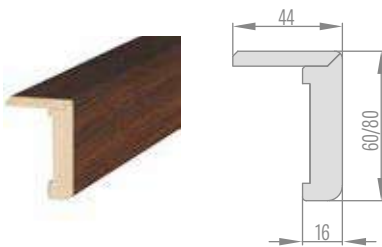

**SQUARE WITH EXTENDED TONGUE  
FOR ADJUSTABLE DOOR FRAME**

Strip 6 cm / Strip 8 cm

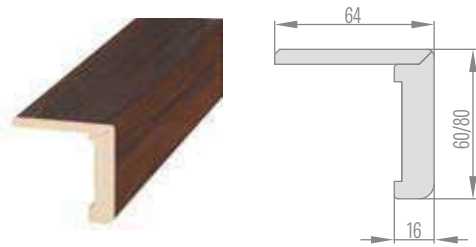

### FIXED DOOR FRAME

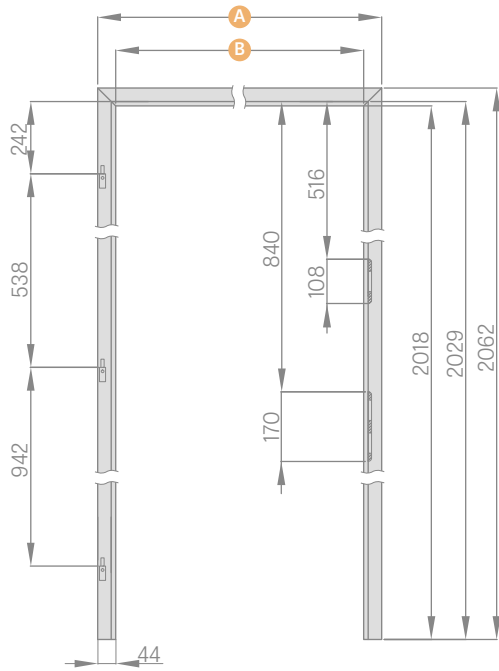

	"60"	"70"	"80"	"90"	"100"
<b>A</b>	692	792	892	992	1092
<b>B</b>	604	704	804	904	1004

### ADJUSTABLE DOOR FRAME

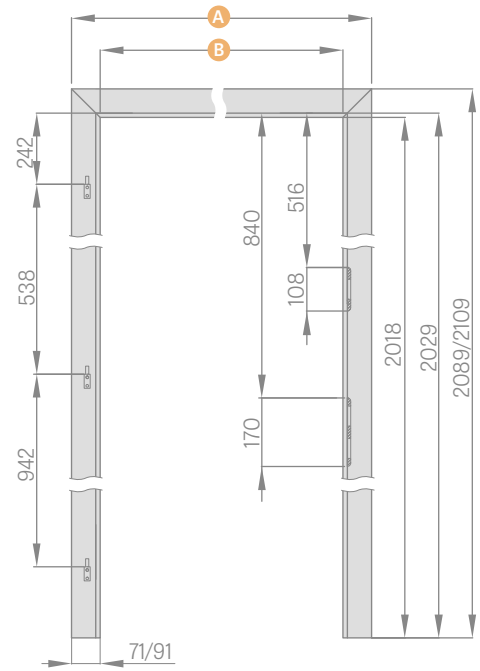

	"60"	"70"	"80"	"90"	"100"
<b>A</b>	746 / 786	846 / 886	946 / 986	1046 / 1086	1146 / 1186
<b>B</b>	604	704	804	904	1004

strip 6cm / strip 8cm

### TUNNEL TYPE ADJUSTABLE DOOR FRAME

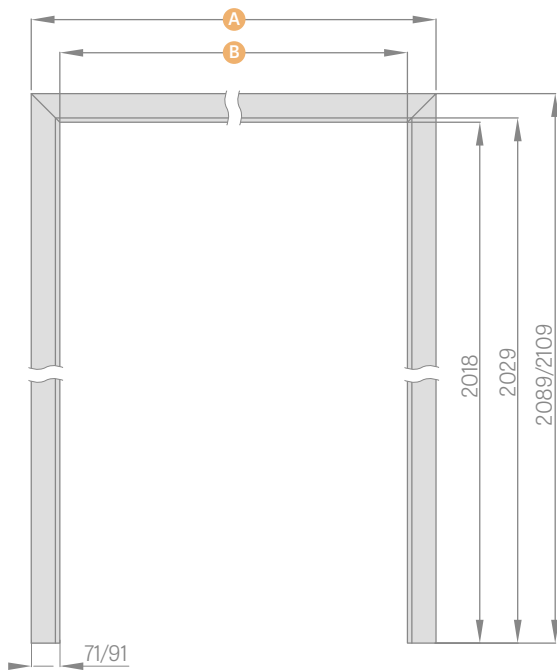

	"60"	"70"	"80"	"90"	"100"	"110"	"120"
<b>A</b>	746 / 786	846 / 886	946 / 986	1046 / 1086	1146 / 1186	1246 / 1286	1346 / 1386
<b>B</b>	604	704	804	904	1004	1104	1204

	"130"	"140"	"150"	"160"	"170"	"180"	"190"
<b>A</b>	1446 / 1486	1546 / 1586	1646 / 1686	1746 / 1786	1846 / 1886	1946 / 1986	2046 / 2086
<b>B</b>	1304	1404	1504	1604	1704	1804	1904

strip 6cm / strip 8cm

### CASING DOOR FRAME

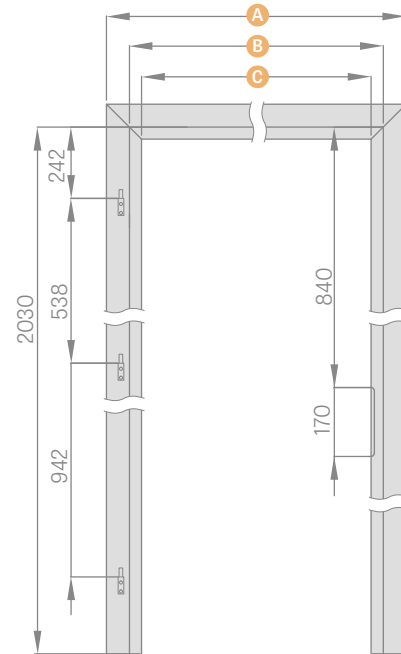

	"60"	"70"	"80"	"90"	"100"
<b>A</b>	737	837	937	1037	1137
<b>B</b>	624	724	824	924	1024
<b>C</b>	564	664	764	864	964

## FIXED DOOR FRAME FOR DOUBLE-LEAF DOORS

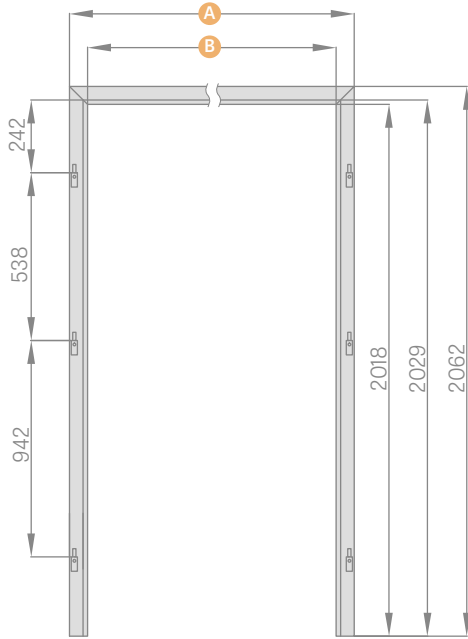

	"90"	"100"	"110"	"120"	"130"	"140"
<b>A</b>	1038	1138	1238	1338	1438	1538
<b>B</b>	950	1050	1150	1250	1350	1450

	"150"	"160"	"170"	"180"	"190"
<b>A</b>	1638	1738	1838	1938	2038
<b>B</b>	1550	1650	1750	1850	1950

## ADJUSTABLE DOOR FRAME FOR DOUBLE-LEAF DOORS

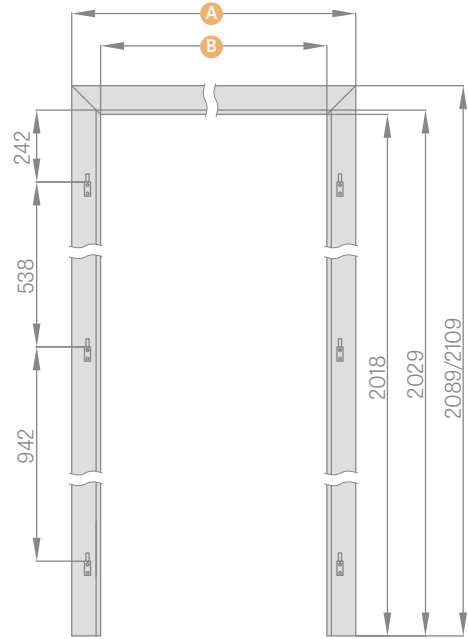

	"90"	"100"	"110"	"120"	"130"	"140"
<b>A</b>	1092/1132	1192/1232	1292/1332	1392/1432	1492/1532	1592/1632
<b>B</b>	950	1050	1150	1250	1350	1450

	"150"	"160"	"170"	"180"	"190"
<b>A</b>	1692/1732	1792/1832	1892/1932	1992/2032	2092/2132
<b>B</b>	1550	1650	1750	1850	1950

strip 6cm /strip 8cm

## FIXED DOOR FRAME FOR GLASS DOORS

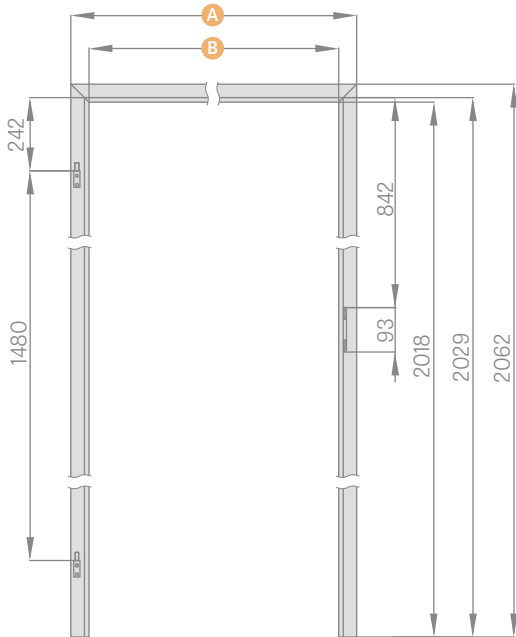

	"60"	"70"	"80"	"90"
<b>A</b>	692	792	892	992
<b>B</b>	604	704	804	904

10 mm pin hinge for glass panes frames

## ADJUSTABLE DOOR FRAME FOR GLASS DOORS

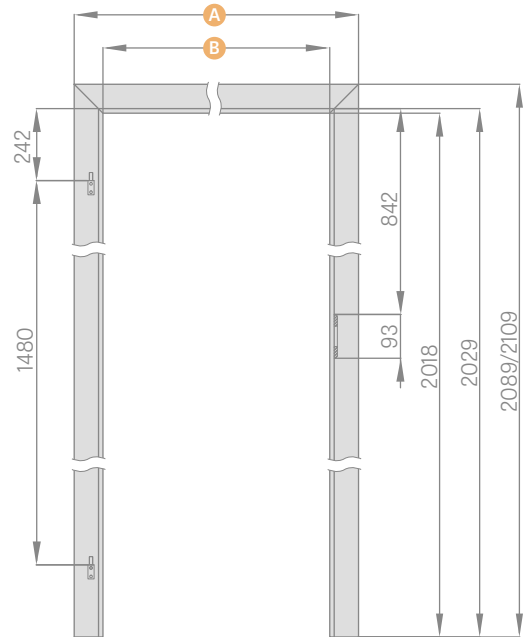

	"60"	"70"	"80"	"90"
<b>A</b>	746/786	846/886	946/986	1046/1086
<b>B</b>	604	704	804	904

strip 6cm /strip 8cm

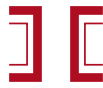

# TUNNEL TYPE ADJUSTABLE DOOR FRAME

## REBATED / NON-REBATED

### TUNNEL TYPE DOOR FRAMES

The tunnel type door frames are adjustable door frames without any hardware. They are made with a top strip and two vertical strips.

They can be used to finish door openings and safeguard wall corners, but mainly are fitted for interior decoration effects.

The tunnel type adjustable rebated door frames are also used in the ERKADO sliding systems.

The tunnel type adjustable non-rebated door frames are not used in the sliding systems.

Depending on the system, we use the following rebated tunnels:

<b>TUNNEL FOR SP1N</b>	Wall-mounted single sliding system
<b>TUNNEL FOR SP2N</b>	Wall-mounted double sliding system
<b>TUNNEL FOR SP1C.100</b>	Single "100" pocket sliding system
<b>TUNNEL FOR SP2C.100</b>	Double "100" pocket sliding system
<b>TUNNEL FOR SP1C.125</b>	Single "125" pocket sliding system
<b>TUNNEL FOR SP2C.125</b>	Double "125" pocket sliding system
<b>Encasing ZN1</b>	Wall encasing for one side of the single leaf systems SP1C.100 and SP1C.125
<b>Encasing ZN2</b>	Wall encasing for one side of the double-leaf systems SP2C.100 i SP2C.125

### ADJUSTABLE REBATED TUNNELS

	"60"	"70"	"80"	"90"	"100"	"110"	"120"	"130"	"140"	"150"	"160"	"170"	"180"	"190"
Opening width in the wall	688	788	888	988	1088	1188	1288	1388	1488	1588	1688	1788	1888	1988
Tunnel outer width	648	748	848	948	1048	1148	1248	1348	1448	1548	1648	1748	1848	1948
Tunnel opening width	604	704	804	904	1004	1104	1204	1304	1404	1504	1604	1704	1804	1904
Tunnel cover width Strip 6 cm /Strip 8 cm	746/ 786	846/ 886	946/ 986	1046/ 1086	1146/ 1186	1246/ 1286	1346/ 1386	1446/ 1486	1546/ 1586	1646/ 1686	1746/ 1786	1846/ 1886	1946/ 1986	2046/ 2086
Opening height in the wall	2060	2060	2060	2060	2060	2060	2060	2060	2060	2060	2060	2060	2060	2060
Tunnel outer height	2040	2040	2040	2040	2040	2040	2040	2040	2040	2040	2040	2040	2040	2040
Tunnel opening height	2018	2018	2018	2018	2018	2018	2018	2018	2018	2018	2018	2018	2018	2018
Tunnel cover height Strip 6 cm /Strip 8 cm	2089/2109	2089/2109	2089/2109	2089/2109	2089/2109	2089/2109	2089/2109	2089/2109	2089/2109	2089/2109	2089/2109	2089/2109	2089/2109	2089/2109

### ADJUSTABLE NON-REBATED TUNNELS

	"60"	"70"	"80"	"90"	"100"	"110"	"120"	"130"	"140"	"150"	"160"	"170"	"180"
Opening width in the wall	713	813	913	1013	1113	1213	1313	1413	1513	1613	1713	1813	1913
Tunnel outer width	673	773	873	973	1073	1173	1273	1373	1473	1573	1673	1773	1873
Tunnel opening width	629	729	829	929	1029	1129	1229	1329	1429	1529	1629	1729	1829
Tunnel cover width strip 6 cm /strip 8 cm	771/ 811	871/ 911	971/ 1011	1071/ 1111	1171/ 1211	1271/ 1311	1371/ 1411	1471/ 1511	1571/ 1611	1671/ 1711	1771/ 1811	1871/ 1911	1971/ 2011
Opening height in the wall	2073	2073	2073	2073	2073	2073	2073	2073	2073	2073	2073	2073	2073
Tunnel outer height	2053	2053	2053	2053	2053	2053	2053	2053	2053	2053	2053	2053	2053
Tunnel opening height	2031	2031	2031	2031	2031	2031	2031	2031	2031	2031	2031	2031	2031
Tunnel cover height strip 6 cm /strip 8 cm	2102/ 2122	2102/ 2122	2102/ 2122	2102/ 2122	2102/ 2122	2102/ 2122	2102/ 2122	2102/ 2122	2102/ 2122	2102/ 2122	2102/ 2122	2102/ 2122	2102/ 2122



# STEEL DOOR FRAME

FOR GRAF STILE, PANEL & GLASS DOOR LEAVES

## ADJUSTABLE STEEL DOOR FRAME (OVERLAPPING), 1.5 mm wide sheet metal 1.5 mm

Welded and coated in RAL 9010, 9016, 8003, 8017, 7016, 7047, 1001

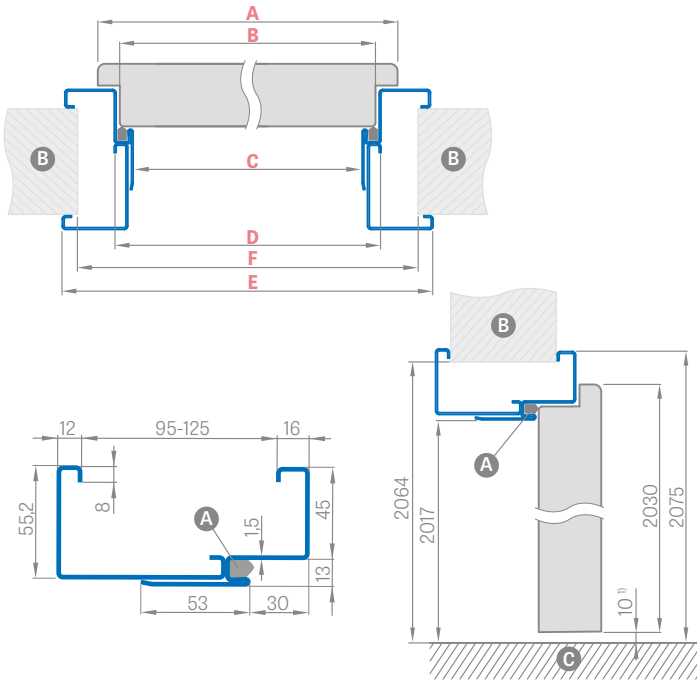

## SQUARE STEEL DOOR FRAME (LARGE), sheet metal 1.2 mm

Welded and coated in RAL 9010, 9016, 8003, 8017, 7016, 7047, 1001

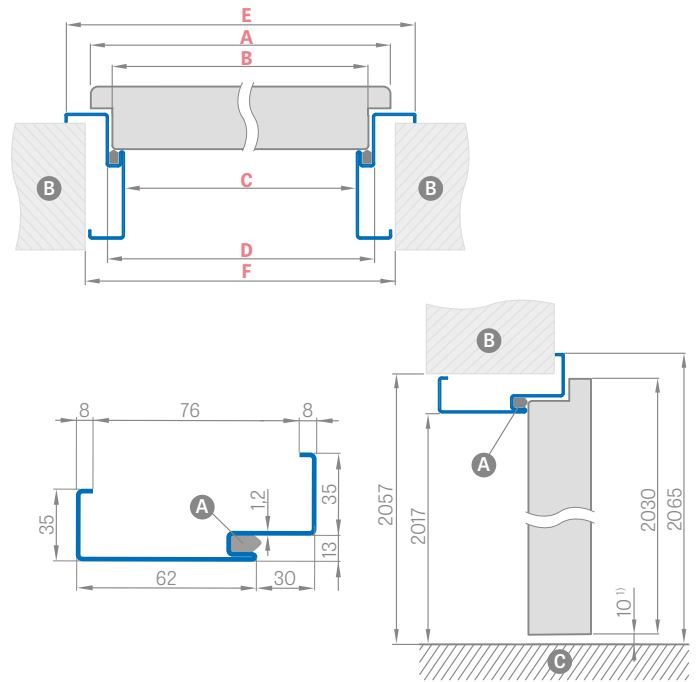

<sup>1)</sup> allowable deviation due to frame dimensional tolerance of +-3mm (we recommend to check before installation)

Door width	A	B	C	D	E	F
"60"	644	617	601	627	717	695
"70"	744	717	701	727	817	795
"80"	844	817	801	827	917	895
"90"	944	917	901	927	1017	995
"100"	1044	1017	1001	1027	1117	1095

Door width	A	B	C	D	E	F
"60"	644	617	601	627	697	681
"70"	744	717	701	727	797	781
"80"	844	817	801	827	897	881
"90"	944	917	901	927	997	981
"100"	1044	1017	1001	1027	1097	1081

Adjustment Range min-max (mm)
95-125
125-155
155-185
185-215
215-245
245-275
275-305

## FITTING THE SQUARE FRAME

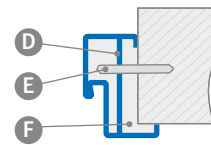

- A** - gasket
- B** - wall
- C** - floor
- D** - mounting anchor
- E** - anchor bolt
- F** - To be filled

## ADDITIONAL CHARGES

- electric door strike
- door closer reinforcement
- galvanised sheet steel
- adjustable "100" door frame
- fixed "100" door frame
- door frame for double-leaf doors
- non-typical RAL (intensive, pearly and metallic colours not included)

## RAL



RAL 9003 RAL 9010 RAL 9016 RAL 8003 RAL 8017 RAL 7016 RAL 7022 RAL 7047 RAL 1001



# ADJUSTABLE OVERLAY DOOR FRAME

## FOR STEEL DOOR FRAMES

### HANDLE POSITION IN AN OVERLAY DOOR FRAME

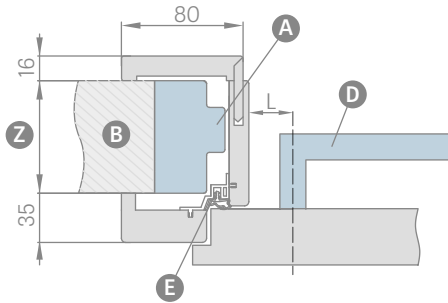

L – distance between the handle centre line and the frame strip edge  
 L = 23 mm for panel doors, SYDNEY or QUBIK handle, p. 124  
 L = 28 mm for STILE frame doors (all interior door handles presented in the offer are available)

**NOTE:** Check the handle face plate dimensions before installation.  
 Adjustable overlay door frame of over 200 mm consists of two components, and a frame of over 320 mm consists of three elements.

### AVAILABLE WIDTHS FOR OVERLAY FRAMES:

**60 70 80 90 100**

	Adjustment range min-max (mm)
1 component	80-100
	100-120
	120-140
	140-160
	160-180
2 components	180-200
	200-220
	220-240
	240-260
	260-280
3 components	280-300
	300-320
	320-340
	340-360
	360-380
	380-400
	400-420
	420-440

### OVERLAY DOOR FRAME DIAGRAM

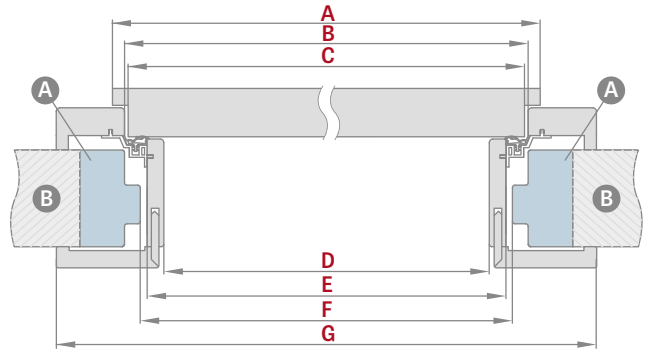

Door width	A	B	C	D	E	F	G
"60"	644	624	618	564	592	598	737
"70"	744	724	718	664	692	698	837
"80"	844	824	818	764	792	798	937
"90"	944	924	918	864	892	898	1037
"100"	1044	1024	1018	964	992	998	1137

F – min dimension of the steel frame opening, on which to fit an overlay door frame. This dimension can exceed the recommended one by max 20 mm. For greater frame opening, ensure the architraves cover the wall appropriately.

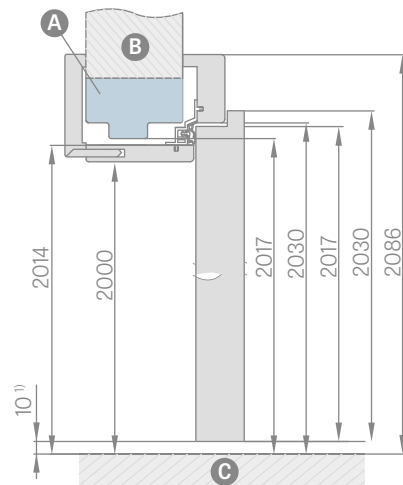

<sup>1)</sup> allowable deviation due to frame dimensional tolerance of +- 3mm (we recommend to check before installation)

- A** – steel door frame
- B** – wall
- C** – floor
- D** – handle
- E** – aluminium profile with gasket
- Z** – range from 80 mm to 255 mm

- 120 mm extension for overlay frame
- Standard square for an overlay frame
- Square with extended tongue
- Tunnel type door frame for widths of 60, 70, 80, 90, 100 are at the price of the adjustable overlay door frame.
- The tunnel is of the same dimensions as the overlay door frame and is not pre-drilled for hinge or door striker plate, but is supplied with a gasket.

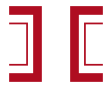

# REVERSE DOOR FRAME

## REVERSE DOOR LEAVES

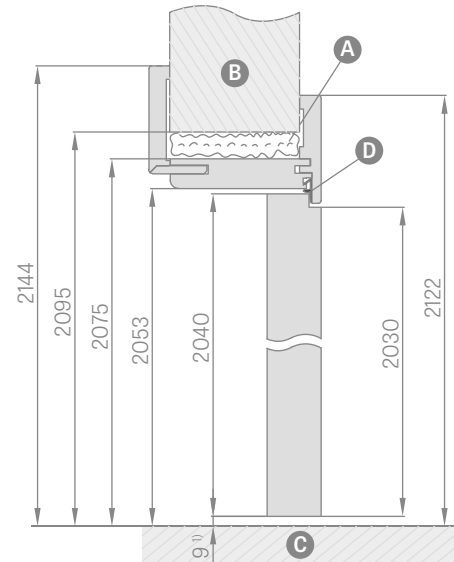
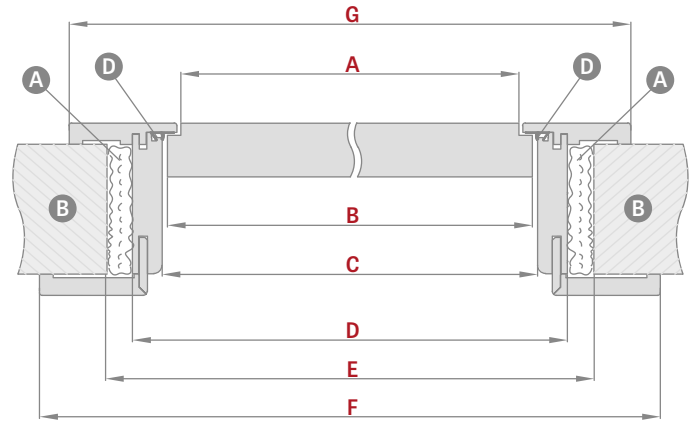
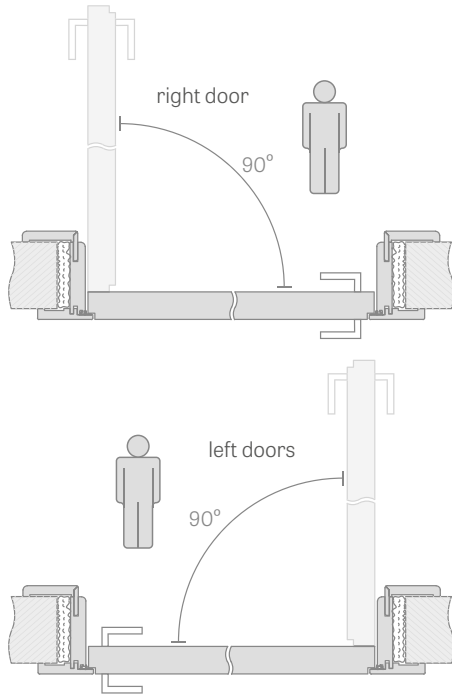

<sup>1)</sup> allowable deviation due to frame dimensional tolerance of  $\pm 3$  mm (we recommend to check before installation)

Door width	A	B	C	D	E	F	G
"60"	624	644	652	696	736	834	791
"70"	724	744	752	796	836	934	891
"80"	824	844	852	896	936	1034	991
"90"	924	944	952	996	1036	1134	1091
"100"	1024	1044	1052	1096	1136	1234	1191

**A** foam **B** wall **C** floor **D** rubber gasket

### ADJUSTMENT RANGE FOR REVERSE DOOR FRAME

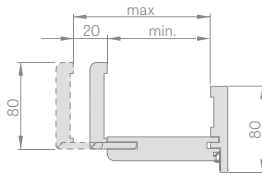

Adjustment range min-max (mm)	
1 component	75-95
	95-115
	115-135
	135-155
	155-175
2 components	175-195
	195-215
	215-235
	235-255
	255-275
	275-295
	295-315
315-335	
335-355	

- The frame for reverse door leaves is available only with an 8 cm square joined at 45 degrees.
- The frame contains two so-called concealed hinges invisible when the leaf is closed
- Available decors within the colour group: GREKO, PREMIUM, CPL and WHITE TITANIUM UV varnish
- The UV WHITE TITAN varnished door frame is also available at an extra cost with an 8 cm corner joined at 90 degrees (not available for the 75-95 mm range) **NEW**

- Can be replaced with hinges and catch plate in black **NEW**
- 120 mm extension for reversible laminate frame
- Movable square with 2 cm leaf extension and standard corner for adjustable frames in all laminates
- The door frame above 255 mm is composed of two parts
- Top panels can be glued to the wall for an additional charge page 134 **NEW**

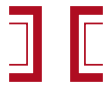

# ADJUSTABLE DOOR FRAME

## NON-REBATED DOOR LEAVES

### ADJUSTABLE DOOR FRAME RANGE 80-95mm

strip 6 cm / strip 8 cm

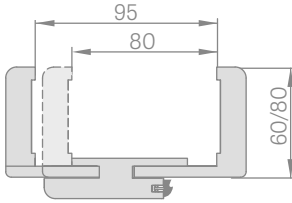

The square tongue is to be cut by customer to required size, for door frames within 80-95mm range

### DOOR FRAME JOINTS

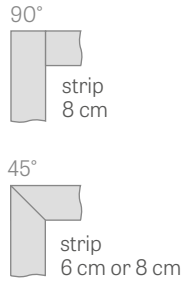

### ADJUSTABLE DOOR FRAME DIAGRAM

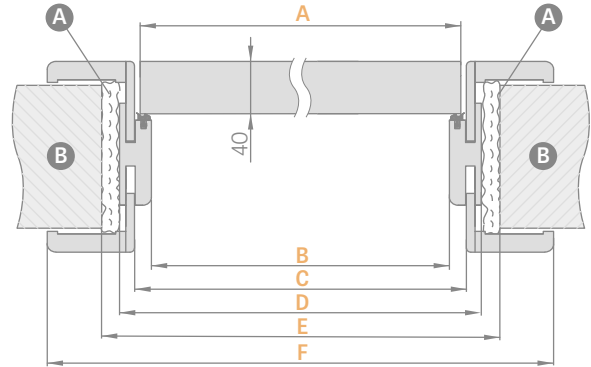

### ADJUSTABLE DOOR FRAME RANGE

strip 6 cm / strip 8 cm

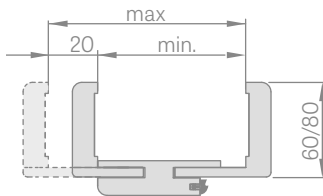

Door width	A	B	C	D	E	F
"60"	644	629	651	673	714	771*/811**
"70"	744	729	751	773	814	871*/911**
"80"	844	829	851	873	914	971*/1011**
"90"	944	929	951	973	1014	1071*/1111**
"100"	1044	1029	1051	1073	1114	1171*/1211**

\* strip 6 cm / \*\* strip 8 cm

Adjustment range min-max (mm)	
1 component	80-95
	95-115
	115-135
	135-155
	155-175
	175-195
	195-215
2 components	215-235
	235-255
	255-275
	275-295
	295-315
	315-335
	335-355
355-375	
375-395	
395-415	

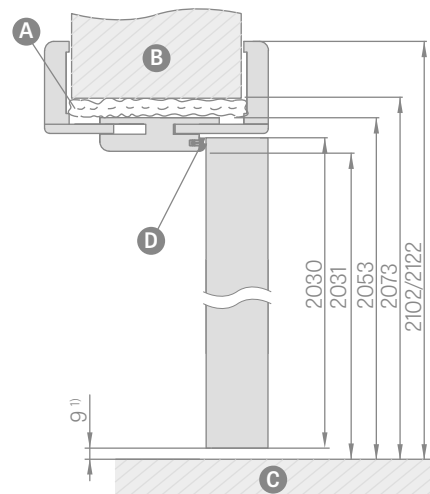

<sup>1)</sup> allowable deviation due to frame dimensional tolerance of +- 3mm (we recommend to check before installation)

**A** foam **B** wall **C** floor **D** rubber gasket

- Adjustable rebate-free door frame in CPL0.2 is also used in combination with doors in CPL0.7
- Can be replaced with hinges and catch plate in black **NEW**
- Joints at 90 degrees possible for door frames with the 8 cm architraves only. Additional charge - frame joints at 90°
- The door frame above 295 mm is composed of two parts
- Prices of adjustable door frames for double-leaf doors + **30%**
- 120 mm extension for rebate-free, laminated door frame
- Movable square with 2 cm leaf extension and standard corner for adjustable frames in all laminates

- Tunnel type door frame for widths of 60, 70, 80, 90, 100 are at the price of the adjustable overlay door frame.
- Tunnel type door frame for widths of 110, 120, 130, 140, 150, 160, 170, 180, 190 are at the price of the adjustable door frame for rebated double-leaf doors (see Table p. 150)
- Top panels glued to the wall (only for frames with 8 cm corner) - p. 134 **NEW**



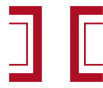

# FIXED DOOR FRAME

## REBATED DOOR LEAVES

### FIXED DOOR FRAME

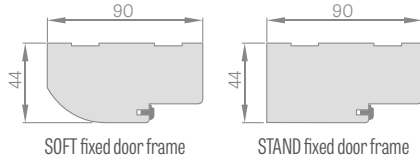

SOFT fixed door frame

STAND fixed door frame

NEW

### CLIP-ON SQUARE 6 cm and 8 cm (3 pcs. of clips supplied)

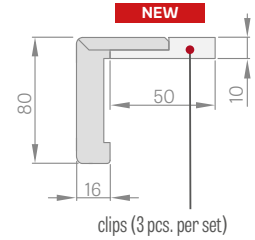

clips (3 pcs. per set)

NEW

### MASKING STRIP 8 mm

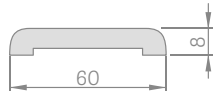

### MASKING STRIP 16 mm

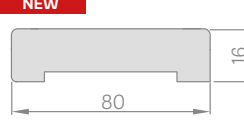

NEW

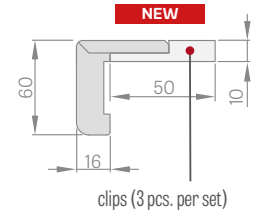

clips (3 pcs. per set)

NEW

### QUARTER ROUND

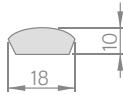

### SOFT AND STAND FIXED DOOR FRAME DIAGRAM

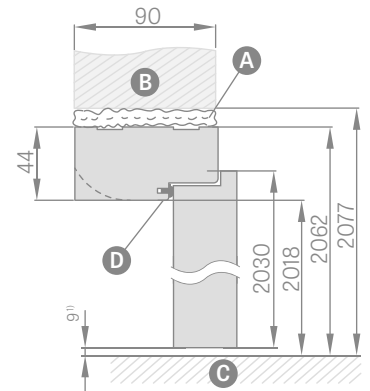
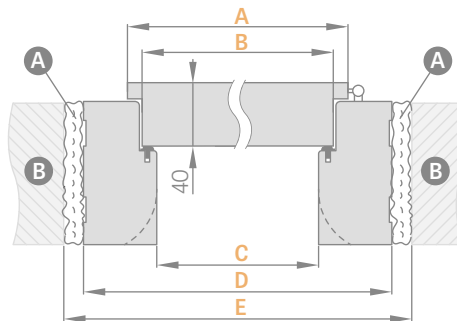

### ELECTRIC DOOR STRIKE

### SKIRTING BOARD length 2,40 mb

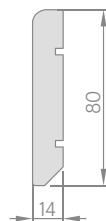

- The skirting board is made of moisture resistant MDF board. Available variants: WHITE TITANIUM UV paint, laminates: GREKO, ST CPL, PREMIUM and in base laminate to be paint coated.
- Fitting method: bonding to wall

<sup>1)</sup> allowable deviation due to frame dimensional tolerance of +- 3mm (we recommend to check before installation)

Door width	A	B	C	D	E
"60"	644	618	604	692	722
"70"	744	718	704	792	822
"80"	844	818	804	892	922
"90"	944	918	904	992	1022
"100"	1044	1018	1004	1092	1122

**A** foam **B** wall **C** floor **D** rubber gasket

- Fixed door frame for double-leaf doors + 30%
- Non-rebated fixed door frame – NA
- The fixed frame, architrave and clip-on square in CPL 0.2 are also used in the set for door leaves in CPL 0.7



# ADJUSTABLE DOOR FRAME

## REBATED DOOR LEAVES



ADJUSTABLE DOOR FRAME  
ABOVE 280 mm

Adjustable door frame above 280 mm is composed of two parts (not within the 260-300mm range), and above 400 mm – three parts (they are not of equal size).

### ADJUSTABLE DOOR FRAME DIAGRAM

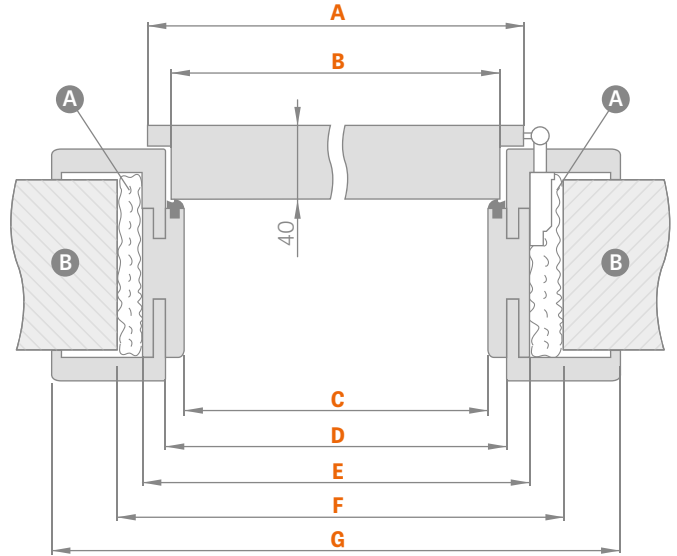

### ADJUSTABLE DOOR FRAME RANGE

strip 6 cm / strip 8 cm

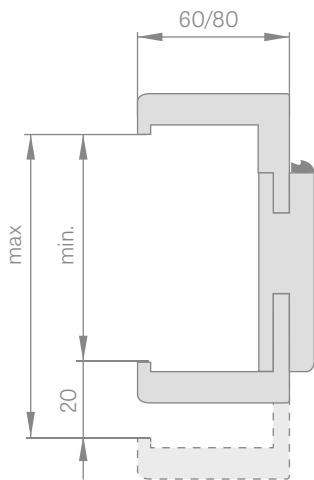

### DOOR FRAME JOINTS

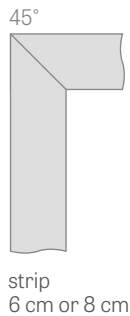
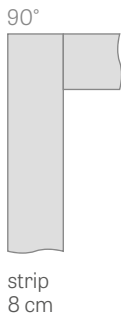

Door width	A	B	C	D	E	F	G
"60"	644	618	604	626	648	688	746*/786**
"70"	744	718	704	726	748	788	846*/886**
"80"	844	818	804	826	848	888	946*/986**
"90"	944	918	904	926	948	988	1046*/1086**
"100"	1044	1018	1004	1026	1048	1088	1146*/1186**

\* strip 6 cm / \*\* strip 8 cm

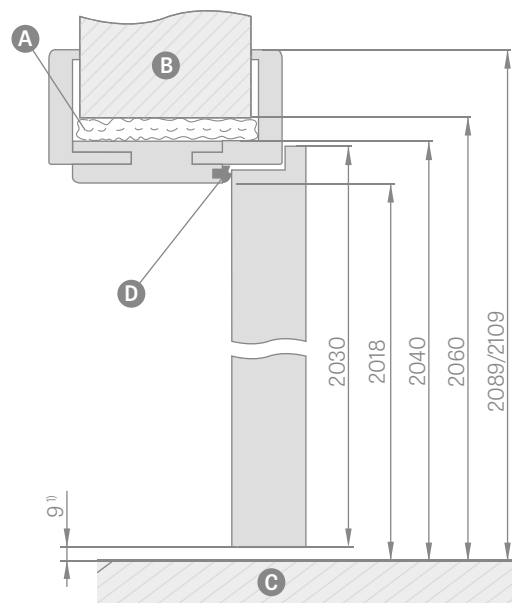

<sup>1)</sup> allowable deviation due to frame dimensional tolerance of +- 3mm (we recommend to check before installation)

**A** foam **B** wall **C** floor **D** rubber gasket

	Adjustment range min-max (mm)
1 component	80-100
	100-120
	120-140
	140-160
	160-180
	180-200
	200-220
	220-240
2 components	240-260
	260-280
	260-300
	280-300
	300-320
	320-340
3 components	340-360
	360-380
	380-400
	400-420

- The CPL 0.2 adjustable rebated frame is also used with CPL 0.7 door leaves
- Joints at 90 degrees possible for door frames with the 8 cm strips only.  
Additional charge for joining at 90 degrees.
- Electric door strike
- Door closer reinforcement
- Prices of fixed and adjustable door frames for double-leaf doors + **30 %**
- Movable square with 2 cm leaf extension and standard corner for adjustable frames in all laminates
- Extension 120 mm for adjustable frame, laminated and CPL 0.2 and lacquered
- It is possible to produce frames up to the range of 500-520 mm
- Tunnel type door frame for both rebated and non-rebated door widths of 60, 70, 80, 90, 100 are at the price of the rebated adjustable door frames.
- Tunnel type door frame for both rebated and non-rebated door widths of 110, 120, 130, 140, 150, 160, 170, 180, 190 are at the price of the adjustable door frame for rebated double-leaf doors
- Top panels glued to the wall (only for frames with 8 cm corner) - p. 134 **NEW**



## **Showroom Drag de Lemn Baneasa**

Adresa: Str. Promoroaca 3A, Sector 1, Bucuresti  
Telefon: 0771461001

[www.dragdelemn.ro](http://www.dragdelemn.ro)

## **Showroom Drag de Lemn Militari**

Adresa: Str. Preciziei 3, Sector 6, Bucuresti  
Telefon: 0771145113

[www.dragdelemn.ro](http://www.dragdelemn.ro)



### **TRANSPORT GRATUIT**

Livram gratuit comanda ta în Bucuresti și Ilfov. Pentru alte zone, tariful se calculează în funcție de comandă și de numărul de kilometri până la adresa ta.



### **MĂSURĂTORI GRATUITE**

Venim la adresa ta pentru a face măsurătorile și pentru a-ți da toate detaliile tehnice necesare. Acest serviciu este gratuit pentru București și Ilfov.



### **MONTAJ DE CALITATE**

Montăm cu echipe proprii toate produsele comercializate. Fie că vorbim de uși de interior, parchet laminat sau scări, montajul va fi întotdeauna la un nivel ridicat.



### **CURĂȚENIE**

Dacă dorești, putem lua ambalajele la finalul montajului pentru a le preda unui centru de reciclare ajutând astfel mediul înconjurător.



### **MODALITĂȚI DE PLATĂ**

Poți plăti comanda ta cu numerar, card sau virament bancar.



### **EXPERTI**

Apelează cu încredere la specialiștii noștri pentru orice nelămurire prin email la [office@upinteriors.ro](mailto:office@upinteriors.ro) sau sunând la numărul de telefon 0726 357 558