



POL-SKONE®
DOORS AND WINDOWS

naturally!



2026

SYSTEMS



REBATED SYSTEM
The door leaf has a rebate (notch, groove) that overlaps the door frame

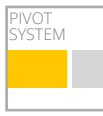

PIVOT SYSTEM
frameless system with the possibility of opening in both directions



NON-REBATED SYSTEM
The straight edge of the door leaf creates a uniform surface with the door frame



HARMONY SYSTEM
system with a door frame concealed in the wall



REVES SYSTEM
The door leaf has a reverse rebate (notch, groove) that creates a uniform surface with the door frame



SLIDING SYSTEM
possibility of use in a sliding system

DIMENSIONS

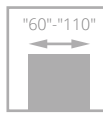

SINGLE-LEAF DOOR
(dimension range)



DOUBLE-LEAF DOOR
(dimension range)

PARAMETERS



PROPERTIES
sound insulation



PROPERTIES
thermal transmittance



PROPERTIES
fire resistance



PROPERTIES
smoke tightness



PROPERTIES
anti-burglary



PROPERTIES
resistance to climatic conditions



PROPERTIES
mechanical class I, II, III or IV



X-RAY



PROPERTIES
protection of the lower edge of the door leaves with a special preservative against moisture

CONSTRUCTION



DOOR LEAF CONSTRUCTION
wooden stile and rail, filling with a "honeycomb" structure layer



DOOR LEAF CONSTRUCTION
laminated wood



DOOR LEAF CONSTRUCTION
wooden stile and rail, perforated chipboard filling



DOOR LEAF CONSTRUCTION
high-quality MDF board



DOOR LEAF CONSTRUCTION
wooden stile and rail, solid chipboard filling



DOOR LEAF CONSTRUCTION
special POL-SKONE construction

ECO TOP ★ ★ ★ ★ ★

It performs excellently in everyday use in households.

UNI MAT PLUS ★ ★ ★ ★ ★
LAMISTONE
SILKSTONE

Laminates with a protective coating against abrasion and the effects of chemical agents. UNI MAT PLUS is a laminate with a silky haptic feel and a coating resistant to fingerprints.

SILKSTONE CPL ★ ★ ★ ★ ★
CPL LAMINATE

Laminates recommended for public utility buildings and for use in conditions of intensive exploitation of door joinery. Available in thicknesses of 0.2 mm and 0.5 mm

HPL LAMINATE ★ ★ ★ ★ ★

Extremely hard and durable surface with high resistance to use. This type of laminate is also used to produce kitchen countertops.

PREMIUM SURFACES

PAINTED ★ ★ ★ ★ ★
MONO1 MAT
MONO2 MAT
MONO3 MAT

Ecological paints from the RAL and NCS palettes in a three-layer painting system ensure color durability for many years. Matt or semi-matt surfaces.

VENEERED ★ ★ ★ ★ ★

Natural veneer coated with ecological UV lacquer, which ensures color durability and scratch resistance.

SILKWOOD ★ ★ ★ ★ ★

Natural veneer coated with ecological paints from the RAL and NCS palettes.

REALWOOD ★ ★ ★ ★ ★

Natural veneer coated with ultra-matt UV lacquer.

HOW TO PRICE DOORS

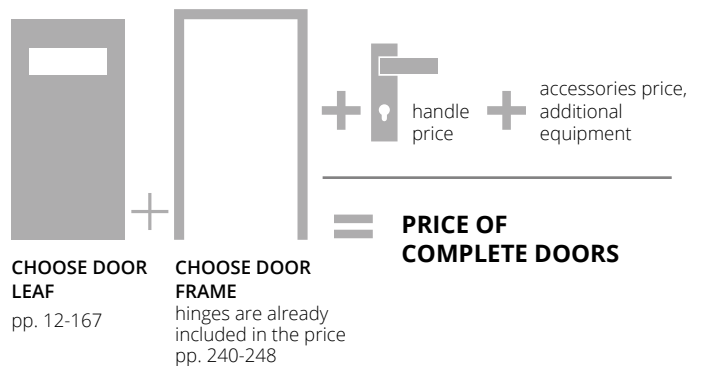

RIGHT OR LEFT DOOR?

right door

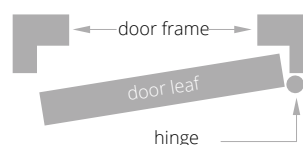

left door

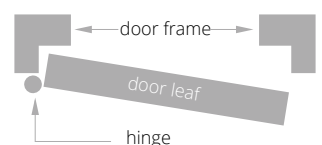

VISION

As a Polish family company, we wish to be the brand of first choice in the premium segment.

MISSION

Since 1990, we have been a manufacturer of the highest quality door and windows. We are building a strong brand associated with reliability, modern design, and technological innovation.

We are a family company, we care about long-term relationships with our business partners, and we treat our employees as our most valuable asset.



Wood is the primary material from which we manufacture our products. The raw material comes from our own sawmills. For the production of door, we use the best materials from proven and experienced suppliers. Production is carried out using the most modern production lines.



Znak odpowiedzialnej
gospodarki leśnej



FSC® and PEFC certificates guarantee that the raw materials used for production come exclusively from responsibly managed forests. This means that they are sourced in accordance with applicable law, environmental protection principles, care for the local community, and attention to economic aspects.

4 FACTORIES AND 2 POL-SKONE SAWMILLS



FACTORY Z1 LUBLIN



FACTORY AND SAWMILL Z2 NIEMCE



FACTORY Z4 LUBLIN



FACTORY AND SAWMILL Z3 BIŁGORAJ

TABLE OF CONTENTS

HIDDEN INTERIOR DOORS

HARMONY FONDO.....	10
HARMONY HIDDEN SYSTEM POL-SKONE.....	12
HARMONY HIDDEN MIRROR.....	14
REG-GO PACKAGE.....	15
FLEXI SYSTEM.....	15
HARMONY INVEST.....	16
HARMONY INVEST PRO.....	18

STEEL INTERIOR DOORS

GALIO.....	22
LOFT ART SLIDING SYSTEM - NEW.....	24
LUMO - NEW.....	26
GALIO PIVOT.....	28
GALIO DOUBLE-LEAF DOOR.....	30
LUMO DOUBLE-LEAF DOOR - NEW.....	32
STALIO.....	34
GALIO / STALIO.....	36

INTERIOR DOORS

DOORS LAMINATED

VISIO - NEW VERSIONS.....	40
VISIO LUX - NEW.....	42
VISIO M - NEW.....	44
VISIO M DOUBLE-LEAF DOOR - NEW.....	46

BESTSELLER

SEDO - NEW VERSION.....	48
VERI - NEW VERSION.....	50
MODO.....	52
EGRO.....	54
ESTO.....	56
ARCO.....	58
UNITO.....	60
SAMOS.....	62
FORTO - NEW VERSION.....	64
MAGRO.....	66
LAURA - NEW.....	68

SEMPRE.....	70
FORTIMO.....	74
SLIM.....	76
MONA.....	78
PASSO.....	80
HAPTIC.....	82
IMPULS.....	84
DECO.....	86
DECO EGGER.....	88
INVERNO.....	90
CREATO.....	92
SONATA - NEW VERSION.....	94
ADORE.....	96
EMPORE.....	98
MAESTO.....	100
SALEA - NEW VERSION.....	102
ETIUDA.....	104
ZENN.....	106

PREMIUM

DOORS PAINTED

MODERN.....	108
VILANO.....	110
MODESTO.....	112
PALAZZO.....	114
VERTIGO.....	116
MODENA.....	118
PRINCESTONE.....	120
CAMBIO.....	122
SUBITO - NEW VERSIONS.....	124
ESTATO.....	126
TIARA.....	128
SENTO.....	130
SUBLIME.....	132
FIORD.....	134
ROYALE.....	136
RIFLO.....	138

DOORS VENEERED

SEMPRE LUX.....	140
SEMPRE LUX.....	142
FORTIMO LUX.....	144
INTERSOLID.....	146
INTERSOLID II.....	148
KINGSTONE.....	150
DECO LUX.....	152
ESPINA.....	154
TEO - NEW VERSIONS.....	156
SONATA LUX - NEW VERSION.....	158
ESTATO LUX.....	160

FOLDING DOORS

FOLDING.....	162
--------------	-----

GLASS DOORS

LUMEN.....	164
LUMEN LOFT.....	166

SLIDING SYSTEMS

WALL-MOUNTED SLIDING SYSTEM.....	168
WALL-MOUNTED SLIDING PREMIUM SYSTEM.....	170
WALL-MOUNTED SLIDING MOVI SYSTEM.....	171
WALL-MOUNTED SLIDING PREMIUM GLASS SYSTEM.....	172
SLIDING SYSTEM FOR INSTALLATION IN THE WALL.....	174
SYNTESIS LINE CASSETTE.....	176

REINFORCED TECHNICAL DOORS

III MECHANICAL CLASS WITH PANEL CONSTRUCTION.....	178
DECO INVEST.....	180
G46.....	182

SPECIAL DOORS

ISOLA GARAGE DOOR - NEW.....	184
SWING.....	186
HIGRO.....	188
GAMMA.....	190

SOUNDPROOF TECHNICAL DOORS

TYPE A / TYPE B.....	192
AKUSTIK 32 DB.....	194
SR 37 DB.....	196
AKUSTIK 42 DB / AKUSTIK SEKURO 42 DB - NEW.....	198

ENTRANCE AND FIRE-RESISTANT DOOR

B-30/C-30	204
B-30 INVEST	206
RC3 INVEST / SR 37 EI30	208
RC3 INVEST 37 DB	210
RC3 / RC3 INVEST	212
CERBER PLUS RC2	214
CERBER PLUS	216
SEGURO / SEGURO PLUS - NEW	218
FR EI30 SR 42 REBATED	220
FR EI30 SR 37 DB NON-REBATED	222
FR EI30 REBATED	224
EI30 PLUS REBATED	226
EI30 PLUS NON-REBATED	228
EI60 PLUS REBATED	230
EI60 PLUS NON-REBATED	232
DOOR LEAF EI30 PLUS, EI60 PLUS, AKUSTIK 32 DB III MECHANICAL CLASS FOR METAL DOOR FRAME	234
FIRE DOORS FOR SHAFTS - EI30, EI60	235
EMERGENCY EXIT	236

DOOR FRAMES AND ACCESSORIES

FIXED POL-SKONE	240
FIXED DUO SYSTEM	241
ADJUSTABLE REBATED	242
ADJUSTABLE NON-REBATED	244
REVES SYSTEM	246
ADJUSTABLE REVES SYSTEM	247
ADJUSTABLE VERTIGO	248
VERTIGO TRANSOM PANEL	249
TUNNELS / WALL ENCLOSURE	251
CROWNS	252
STRIPS	253
SKIRTING BOARDS	253
ALUMINUM SKIRTING BOARDS	253
FIXED METAL POL-SKONE SYSTEM	254
FIXED METAL DUO POL-SKONE SYSTEM	255
ADJUSTABLE METAL POL-SKONE SYSTEM	256
ADJUSTABLE METAL DUO POL-SKONE SYSTEM	257
FIXED METAL DIAGONAL POL-SKONE SYSTEM	258
ADJUSTABLE METAL DIAGONAL POL-SKONE SYSTEM	259
FIXED METAL LUMEN	260
ADJUSTABLE METAL LUMEN	261
ADJUSTABLE METAL FOR DOORS EI30 PLUS, EI60 PLUS	262
ADJUSTABLE METAL DUO FOR DOORS EI30 PLUS, EI60 PLUS	263
FIXED METAL FOR DOORS EI30 PLUS, EI60 PLUS	264
FIXED METAL DUO FOR DOORS EI30 PLUS, EI60 PLUS	265
ADJUSTABLE METAL G46 POL-SKONE SYSTEM	266
ADJUSTMENT SYSTEM WITH MDF FOR FIXED METAL DOOR FRAME	267
ADJUSTABLE DOOR FRAMES FOR ENTRANCE DOORS	268
WOODEN DOOR FRAMES FOR TECHNICAL DOORS	269

WALL PANELS	271
GROOVED WALL PANELS	271
NON-STANDARD ENCLOSURES WITH CASINGS	272
NON-STANDARD ENCLOSURES WITH PANEL	273
METAL TOP AND SIDE LIGHTS	274
TOP AND SIDE LIGHTS FOR DIN/DIN DUO DOOR FRAME	275
TOP AND SIDE LIGHTS FOR FIXED DOOR FRAME	276
TOP AND SIDE LIGHTS FIRE-RESISTANT	276
EQUIPMENT FOR INTERIOR DOORS	277
ACCESSORIES	278
ABS EDGE	285
PORTHOLES	285
VENTILATION OPTIONS	286
ADDITIONAL EQUIPMENT	288
INTERIOR DOORS FOR ROOMS WITH HEAT RECOVERY VENTILATION SYSTEM	289
CAMBIO DOOR LEAFS WITH PICTOGRAM	290
STAINLESS STEEL PANEL WITH ICONS	290
DECORATIVE ELEMENTS	291
ALUMINUM DECORS	291
HANDLES FOR INTERIOR DOORS	292
CYLINDERS FOR INTERIOR DOORS	293
HANDLES FOR ENTRANCE AND EXTERIOR DOORS	294
CYLINDERS FOR ENTRANCE AND TECHNICAL DOORS	295
DIMENSIONS - INTERIOR DOORS	296
DIMENSIONS - TECHNICAL DOORS	297
DIMENSIONS OF DOOR LEAFS FOR INTERIOR DOORS	300
IMPORTANT USER INFORMATION	301
GLASS AND GLAZING	302

COLOR RANGE

COLOR RANGE	303
COLOR RANGE OF STEEL DOORS AND METAL DOOR FRAMES	311
HPL LAMINATES	312
TWO-COLORED DOORS	312
STANDARD PARAMETERS OF POL-SKONE DOORS	313
ADDITIONAL INFORMATION	313
COLOR RANGE OF INTERIOR DOORS	314
DOOR FRAMES FOR INTERIOR DOORS	315

You will also find information about our assortment under the QR codes:



HIDDEN DOORS



SLIDING DOORS



ENTRANCE DOORS



LOFT AND STEEL DOORS



FIRE DOORS



DOOR FRAMES



INTERIOR DOORS



SPECIAL DOORS



WALL PANELS



ACCESSORIES

CHOOSE YOUR DREAM DOOR

Color range

Do you prefer a uniform UNI color or the natural appearance of wood with a visible grain pattern? We have the color you are looking for! Are you looking for a door in a natural finish, painted, or laminate? You will find them all with us. In our offer, you can adjust these parameters to your expectations. You will find the full color range of our products on pages 303-310



Construction

Choose the construction that meets your aesthetic and functional needs.

- panel type** - simple door leafs with decorative frames or millings
- stile and rail type** - distinct form and details in the form of panels, glass panes, and infills



STILE AND RAIL TYPE



stile and rail made of laminated wood

MDF stile and rail with a thickness of 40 mm upper and lower edges protected against moisture using HOT FOIL technology

PANEL TYPE



wooden stile and rail, double-sided cladding 3,5 mm, lower edges protected with preservative

"honeycomb" filling

perforated chipboard filling

solid chipboard filling

Design

In our offer you will find doors in a wide stylistic range:

- solid - simple doors with a minimalist appearance
- solid with decorative details in the form of frames, profiles, millings, embossings
- with vertical or horizontal glazing in various configurations: with several glass panes or one, with a large or small glazed area



SOLID



SOLID WITH DECORATIVE ELEMENTS



GLAZING HORIZONTAL



GLAZING VERTICAL

CONSTRUCTION / DESIGN:

COLOR RANGE

**SOLID COLOR
RANGE UNI
LAMINATED**

**STILE AND RAIL TYPE
WITH MDF**

**STILE AND RAIL TYPE
WOODEN**

PANEL TYPE

SEDO p. 48	SEMPRE p. 70, 72	HAPTIC p. 82
VERI p. 50	FORTIMO p. 74	IMPULS p. 84
MODO p. 52	VISIO p. 40	DECO p. 86
EGRO p. 54	VISIO M p. 44, 46	DECO EGGER p. 88
ESTO p. 56	SLIM p. 76	INVERNO p. 90
ARCO p. 58	MONA p. 78	CREATO p. 92
UNITO p. 60	PASSO p. 80	SONATA p. 94
		ADORE p. 96
		EMPORE p. 98
		MAESTO p. 100
		SALEA p. 102
		ETIUDA p. 104

**WOOD COLOR
RANGE
LAMINATED**

FORTO p. 64	SEMPRE p. 70, 72	INVERNO p. 90
MAGRO p. 66	FORTIMO p. 74	SALEA p. 102
SAMOS p. 62	MONA p. 78	SONATA p. 94
ESTO p. 56	SLIM p. 76	ETIUDA p. 104
ARCO p. 58	VISIO p. 40	IMPULS p. 84
LAURA p. 68	VISIO M p. 44, 46	DECO EGGER p. 88

**FABRIC
STRUCTURE
LAMINATED**

		ZENN p. 106
--	--	-------------

**SOLID COLOR
RANGE UNI
PAINTED**

	MODERN p. 108	CAMBIO p. 122
	VILANO p. 110	SUBITO p. 124
	MODESTO p. 112	ESTATO p. 126
	PALAZZO p. 114	TIARA p. 128
	VERTIGO p. 116	SENTO p. 130
	MODENA p. 118	SUBLIME p. 132
	PRINCESTONE p. 120	FIORD p. 134
		ROYALE p. 136
		RIFLO p. 138

**WOOD COLOR RANGE
VENEERED**

	SEMPRE LUX p. 140, 142	DECO LUX p. 152
	FORTIMO LUX p. 144	ESPINA p. 154
	INTERSOLID p. 146	TEO p. 156
	INTERSOLID II p. 148	SONATA LUX p. 158
		ESTATO LUX p. 160

**VENEER PAINTED
WITH OPAQUE PAINTS
SILKWOOD**

	KINGSTONE p. 150	
		DECO LUX p. 152

**COLOR RANGE VENEER
COATED WITH ULTRA-
MATT UV LACQUER
REALWOOD**

	FORTIMO LUX p. 144	ESPINA p. 154
	INTERSOLID p. 146	DECO LUX p. 152
	SEMPRE LUX p. 140-142	ESTATO LUX p. 160
		SONATA LUX p. 158

PREMIUM

HIDDEN DOORS



unlimited possibilities

HARMONY - p. 12

HARMONY MIRROR - p. 14

REG-GO PACKAGE - p. 15

flexi system for HARMONY door frame - p. 15

HARMONY INVEST - p. 16

HARMONY INVEST PRO - p. 18



PAINTED



TILES
(up to a thickness of 4 mm)

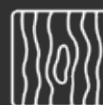

VENEER



LAMINATES



MIRROR

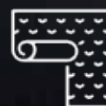

WALLPAPER



DECORATIVE
ELEMENTS



DEDICATED CATALOG
HARMONY DOOR

Hidden doors **HARMONY FONDO** with **HARMONY** door frame

For those who are looking for more than just a door

This is a solution for architects, investors, and clients individual, who value not only appearance but also function. Hidden door is a new standard in design of modern spaces – from luxurious apartments to elegant offices.



The door leaf **HARMONY FONDO** is another version of the model for the hidden aluminum door frame system from the **HARMONY** family.







The door leaf is available in a primer for self-painting. The primer is applied using an innovative, highly energy-efficient method of applying primer paint with lacquer rollers.

Doors that are invisible. Quality you can feel.

Minimalism has a new definition. The hidden door **HARMONY FONDO** **blends into the wall**, creating a uniform surface without visible door frames.

But it is not only about design – it is also about **quality** you can feel with every closing. Made from natural materials, durable and precisely finished.

Why are they different from all the others?

-  **Wooden stile and rail and top-quality fillings**
guarantee durability and stability
-  **The patented aluminum door frame**
ensures perfect fit, easy installation, and stability
-  **Top-quality locks and solid hinges**
– for years without compromise
-  **Full freedom of finishing**
– paint, wallpaper, attach a mirror, stucco, or tiles
-  **Ideal** for any interior, **including bathrooms**
and rooms with increased humidity
-  **Available immediately**
– shipping within 24 hours



DOORS AVAILABLE IMMEDIATELY!

HARMONY FONDO DOOR LEAF FOR SELF-FINISHING

- widths: "70", "80", "90"; standard height
- opening directions: left, right
- opening variants: inward opening ODW or outward opening ODZ
- filling: perforated board

DOOR FRAME FOR SELF-PAINTING

- raw aluminum
- fittings: concealed hinges adjustable in 3 planes in satin chrome color, magnetic lock WK (without key) and WC satin chrome

HARMONY MIRROR DOOR LEAF IN FONDO SURFACE FOR SELF-APPLICATION OF MIRROR

- width "80", standard height
- opening directions: left, right
- opening variants: inward opening ODW or outward opening ODZ
- filling: perforated board

HARMONY MIRROR DOOR FRAME FOR SELF-PAINTING

- raw aluminum
- fittings: satin chrome hinges, magnetic lock WK (without key) and WC satin chrome

MOST FREQUENTLY CHOSEN SETS DOOR LEAF + HARMONY DOOR FRAME

door leaf in HARMONY FONDO primer for self-finishing*
+ raw ALU door frame for self-painting

door leaf in primer for self-finishing*
+ raw ALU door frame for self-painting

door leaf in primer for self-finishing*
+ filling made of perforated chipboard
+ raw ALU door frame for self-painting

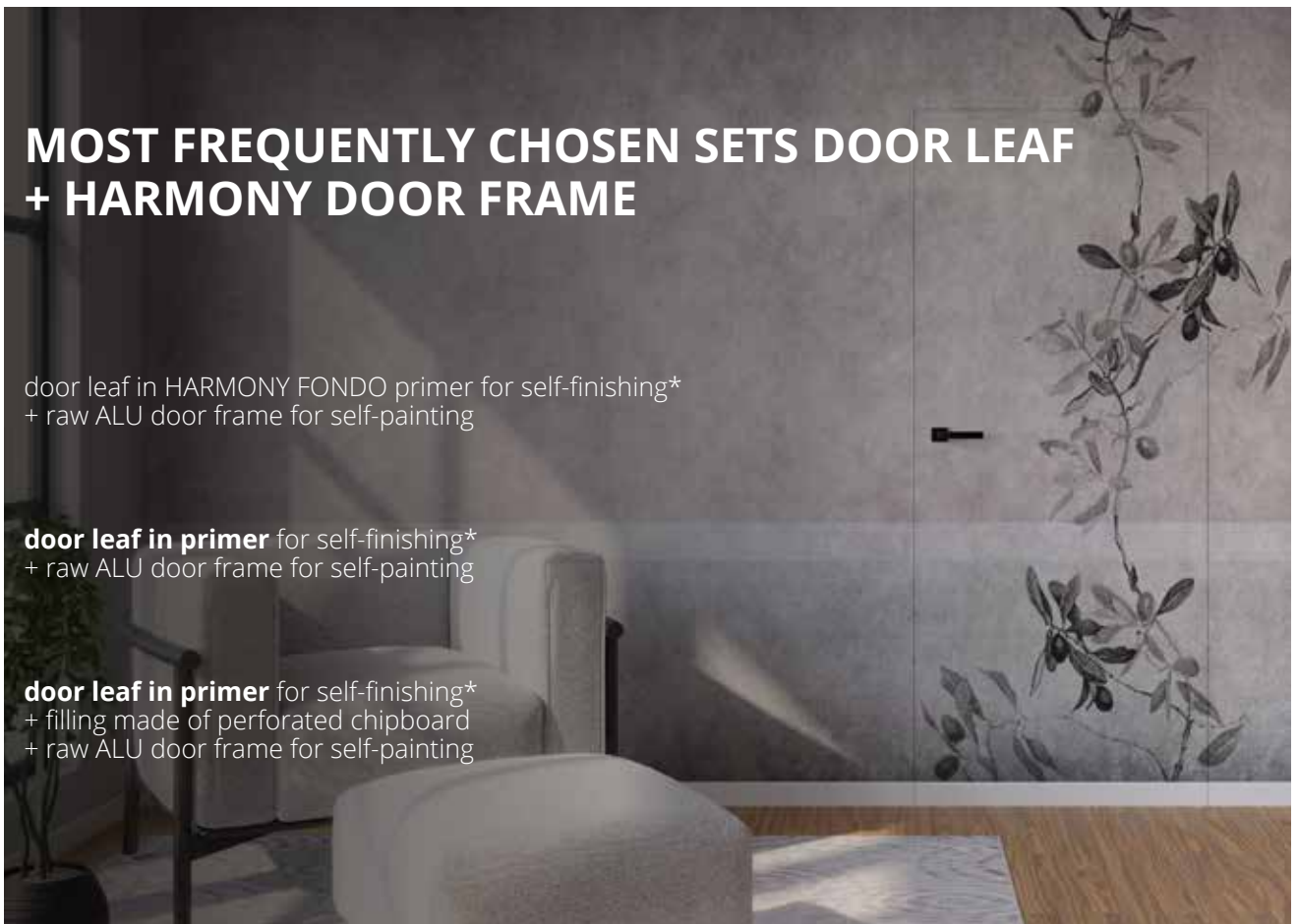

* applies to door leaves width "60"- "80" cm x height 2030/2020 mm

HARMONY HIDDEN SYSTEM POL-SKONE



HIDDEN DOORS

HARMONY



"60"- "100"



"120"- "200"



HARMONY door with HARMONY hidden door frame

Door leaf, on which you can attach a mirror or a decorative tile with a thickness of 4 mm.

This option allows for the creation of an elegant, functional finish of the door leaf, ideal for wardrobes, hallways, or bathrooms.

The solution requires the use of a door leaf thinned by 4 mm (ODZ or ODW) and a solid core, which ensures appropriate stability and durability of the structure.

(details in the extra charge table p.13)

mechanical class: 2nd class of mechanical strength i.e. medium operating conditions

*single-leaf door with HARMONY hidden door frame with solid core filling, equipped with a drop seal, has a sound insulation parameter of **Rw=27 dB**



HARMONY door with HARMONY hidden door frame

DOOR LEAF

height		standard	higher by 100 mm	higher by 200 mm	higher by 300 mm	higher by 400 mm				
raw door leaf with HARMONY FONDO primer for self-finishing	raw door leaf with primer for self-finishing	LAMISTONE	Laminated CPL 0.2	PAINTED 9003 white hinges	MONO1 MAT white hinges	MONO2 MAT black hinges	MONO3 MAT black hinges	VENEERED Group A	VENEERED Group B	VENEERED Group C, D, SILKWOOD, REALWOOD
		SILKSTONE								
		UNI MAT PLUS								

DOOR FRAMES

height	standard	higher by 100 mm	higher by 200 mm	higher by 300 mm	higher by 400 mm
door frame for self-painting (raw aluminum)	QL anodized silver hinges	PAINTED 9003, MONO1* white hinges	MONO2** black hinges		

*does not apply to colors NCS S 1002-Y50R, NCS S 1502Y-50R, NCS S 0500-N, NCS S 0502-Y

**does not apply to the NCS palette

number of hinges	
height / width	standard
"60"	2
"70"	
"80"	
"90"	3
"100"	

single-leaf door					double-leaf door				
type	S _d *	S _d **	S _o	S _s	type	S _d *	S _o *	S _d **	S _o **
"60"	693	696	710	625	"60"+"60"	1309	1325	1315	1330
"70"	793	796	810	725	"70"+"70"	1509	1525	1515	1530
"80"	893	896	910	825	"80"+"80"	1709	1725	1715	1730
"90"	993	996	1010	925	"90"+"90"	1909	1925	1915	1930
"90 plus"	1018	1021	1035	950	"100"+"100"	2109	2125	2115	2130
"100"	1093	1096	1110	1025					

	H _s	H _d	H _o
* door opening outwards	2020*	2062*	2070*
** door opening inwards			

S_d, H_d - width/height of the door on the external side of the door frame

S_o, H_o - width/height of the installation opening

S_s, H_s - width/height of the door leaf

INCLUDED IN THE PRICE OF THE DOOR

The structure of the door leaf consists of a stile and rail made of softwood, covered on both sides with HDF boards, filled with a layer of "honeycomb" structure. **The construction of the door allows it to be flush with the wall surface.** The thickness of the door leaf is 40 mm.

HARMONY HIDDEN SYSTEM

concealed hinge (adjustable in 3 planes), satin chrome color – number of hinges according to the table above

magnetic lock, satin chrome: for key, cylinder, bathroom lock, without keyhole

FOR EXTRA CHARGE

possibility to order HARMONY doors shortened by every 10 mm – maximum shortening 100 mm without extra charge

perforated chipboard filling

solid chipboard filling

adaptation of the door leaf for installation of a single-sided mirror or tile with a thickness of 4 mm (door leaf thinned by 4 mm ODZ and ODW) – requires the use of solid chipboard filling and an additional hinge ("60"."80" – 3 pcs.; "90"."100" – 4 pcs.) – does not apply to HARMONY FONDO

* for inward opening doors after consultation with the Sales Department

PRICE (PLN) **net**/gross (VAT 23%)

additional concealed hinge in white, black, or silver color

additional concealed hinge in gold color

change of hinge color to white or black without extra charge

change of hinge color to gold

preparation for an additional hinge (extra charge for the door leaf)

HOBES 2784 WB roller lock

adaptation of the door frame for HOBES 2784 roller lock (door opening outwards)*

possibility to order a door frame with EFF-EFF 138.13 E91 ProFix 2 reverse electric strike or EFF-EFF 118.13 A71 ProFix2 standard electric strike (door opening outwards)* p. 284

door frames in other colors according to the extra charge table p. 311

PVC protective covers for the door frame (1 set)

door closers, electric strikes pp. 281, 283

ventilation undercut pp. 286-287

drop seal (not possible to use in a door leaf thinned by 4 mm)

heat recovery ventilation without extra charge

REG-GO package

HARMONY HIDDEN MIRROR

FOR INSTALLATION WITH A MIRROR



Hidden door for installation with a 4 mm mirror, which allows you to create a uniform surface with a mirror affixed to the wall

- door leaf thickness 40 mm
- perforated board filling
- opening outwards

DOOR LEAF

height		standard			higher by 100 mm		higher by 200 mm	
raw door leaf in primer for self-finishing	LAMISTONE	PAINTED 9003 white hinges	MONO1 MAT white hinges	MONO2 MAT black hinges	MONO3 MAT black hinges	VENEERED Group A	VENEERED Group B	VENEERED Group C, D, SILKWOOD, REALWOOD
	SILKSTONE							
	UNI MAT PLUS							

DOOR FRAMES

height	standard	higher by 100 mm	higher by 200 mm	higher by 300 mm	higher by 400 mm
door frame for self-painting (raw aluminum)	QL anodized silver hinges	PAINTED 9003, MONO1* white hinges	MONO2** black hinges		
number of hinges					
height/ width	standard				
"60"	3				
"70"					
"80"					
"90"					
"100"					

*does not apply to colors NCS S 1002-Y50R, NCS S 1502Y-50R, NCS S 0500-N, NCS S 0502-Y
 **does not apply to the NCS palette

INCLUDED IN THE PRICE OF THE DOOR

The construction of the door leaf consists of a stile and rail made of softwood, covered on both sides with HDF boards, filled with perforated chipboard. **The door construction allows for self-installation of a 4 mm thick mirror on the hinge side.** The thickness of the door leaf is 40 mm (without the mirror).

HIDDEN SYSTEM HARMONY MIRROR

reinforced concealed hinge (adjustable in 3 planes) satin chrome color – number of hinges according to the table
 magnetic lock silver for key, cylinder, bathroom lock, without keyhole

FOR EXTRA CHARGE

additional concealed hinge for the Harmony Mirror door frame
 change of magnetic lock color to white, black or gold
 ventilation undercut pp. 286-287
 heat recovery ventilation without extra charge
 REG-GO package

REG-GO PACKAGE

package for stabilizing the position of hidden door leaves HARMONY and HARMONY MIRROR, door leaves of panel construction (not applicable to glazed versions) and ISOLA door leaves

Package contents

- stabilizing rods (2 pcs.) mounted in the door leaf on the lock and hinge sides
- structural wooden strip, 120 mm wide, on the lock and hinge sides

package for stabilizing the position of hidden door leaves HARMONY, HARMONY MIRROR and ISOLA, as well as door leaves of panel construction (not applicable to glazed versions)

stabilizing rods (2 pcs.) mounted in the door leaf on the lock and hinge sides

structural wooden strip, 120 mm wide, on the lock and hinge sides

door higher by 100 mm, 200 mm, 300 mm, 400 mm

door lower by 10 mm from standard (entire set) or 15 mm (door leaf only – heat recovery ventilation)

not possible to use a drop seal

not possible to use a ventilation undercut

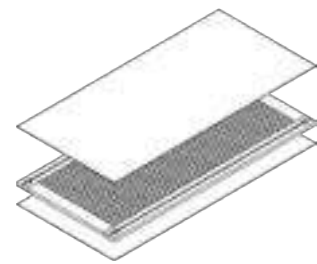

DOOR LEAF CONSTRUCTION

Hex key (Allen) 5 mm

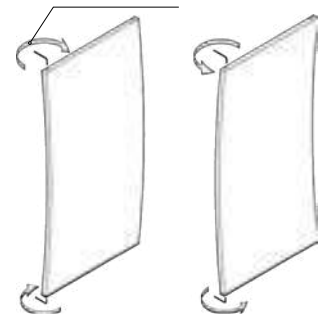

DOOR LEAF PLANE ADJUSTMENT



FLEXI SYSTEM

**PATENTED
VERSION**

MDF adjustment system for the **HARMONY, HARMONY MIRROR door frame**



trims joined at a 45° angle

symbol	range in mm*	symbol	range in mm*	PAINTED 9003**	MONO1 MAT	MONO2 MATT	MONO3 MATT	UNI MAT PLUS LAMISTONE SILKSTONE	VENEERED GROUP B (323, 400, 404, 405, 421, 422, 424)
HW1	85-90	HZ1	95-100						
HW2	90-95	HZ2	100-105						
HW3	95-105	HZ3	105-115						
HW4	105-130	HZ4	115-140						
HW5	130-150	HZ5	140-160						
HW6	150-170	HZ6	160-180						
HW7	170-190	HZ7	180-200						
HW8	190-210	HZ8	200-220						
HW9	210-230	HZ9	220-240						
HW10	230-250	HZ10	240-260						
HW11	250-270	HZ11	260-280						
HW12	270-290	HZ12	280-300						
HW13	290-310	HZ13	300-320						

* the thickness of the given aluminum door frame is included in the adjustment range
** available only with trims of 80 mm width

Trims joined at a 90° angle (applies to trim version C 90°)

COMPONENT ASSEMBLY					
adjustment range HARMONY ODW	adjustment range HARMONY ODZ	adjustable angle trim	panel		
HW1	85-90	HZ1	95-100	12 mm	46 mm
HW2	90-95	HZ2	100-105	12 mm	51 mm
HW3	95-105	HZ3	105-115	16 mm	56 mm
HW4	105-130	HZ4	115-140	32 mm	66 mm
HW5	130-150	HZ5	140-160	32 mm	91 mm
HW6	150-170	HZ6	160-180	32 mm	111 mm
HW7	170-190	HZ7	180-200	32 mm	131 mm
HW8	190-210	HZ8	200-220	32 mm	151 mm
HW9	210-230	HZ9	220-240	32 mm	171 mm
HW10	230-250	HZ10	240-260	32 mm	191 mm
HW11	250-270	HZ11	260-280	32 mm	211 mm
HW12	270-290	HZ12	280-300	32 mm	231 mm
HW13	290-310	HZ13	300-320	32 mm	251 mm

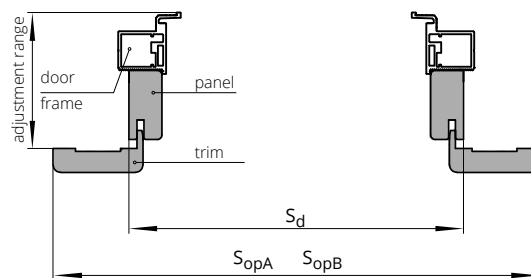

Installation dimension	opening inwards						opening outwards					
	Sd	SopA	SopB	Hd	HopA	HopB	Sd	SopA	SopB	Hd	HopA	HopB
"60"	683	783	823				663	763	803			
"70"	783	883	923				763	863	903			
"80"	883	983	1023	2066	2116	2136	863	963	1003	2047	2097	2117
"90"	983	1083	1123				963	1063	1103			
"90 plus"	1008	1108	1148				988	1088	1188			
"100"	1083	1183	1223				1063	1163	1203			

Maximum installation height ODW – Hd 2266 mm
Maximum installation height ODZ – Hd 2247 mm

The FLEXI system is sold as a set with a door frame

Sd – installation width
SopA – width on the outer side of the trim "60 mm"
SopB – width on the outer side of the trim "80 mm"
Hd – installation height
HopA – height on the outer side of the trim "60 mm"
HopB – height on the outer side of the trim "80 mm"



HARMONY INVEST

HIDDEN DOORS

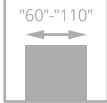

acoustic insulation
Rw = 37 dB

Interior entrance doors intended for rooms in public utility buildings, including offices, hotels, etc.

door width "60" - "90" - **4th class of mechanical strength** according to PN-EN 1192:2001
 door width "90 plus" - "110" - **3rd class of mechanical strength** according to PN-EN 1192:2001
 Acoustic insulation: **Rw= 37 dB, D₁-35, D₂-30**
 National Technical Assessment **ITB-KOT-2022/2187** edition 1

raw door leaf in primer for self-finishing

- _____ LAMISTONE CPL
- _____ UNI MAT PLUS
- _____ SILKSTONE
- _____ SILKSTONE CPL 0.5 mm
- _____ LAMINATED CPL 0.2 mm
- _____ PAINTED 9003
- _____ MONO1 MAT
- _____ MONO2 MAT
- _____ MONO3 MAT
- _____ VENEERED GROUP A
- _____ VENEERED GROUP B
- _____ VENEERED GROUP C, D
- _____ SILKWOOD / REALWOOD

DOOR FRAMES

door leaf width [mm]	625-960	1025-1125	625-960	1025x1125	625-960	1025x1125	625-960	1025-1125	625-960	1025-1125
door leaf height [mm]	2030/2020		2130/2120		2230/2220		2330/2320		2430/2420	
number of hinges	2 pcs.	3 pcs.	3 pcs.	3 pcs.	3 pcs.	3 pcs.	3 pcs.	3 pcs.	3 pcs.	3 pcs.

for self-finishing	QL anodized	PAINTED 9003	MONO1*	MONO2**
--------------------	-------------	--------------	--------	---------

extra charge for structural colors

*does not apply to colors NCS S 1002-Y50R, NCS S 1502Y-50R, NCS S 0500-N, NCS S 0502-Y
 **does not apply to the NCS palette



HARMONY INVEST door with aluminum door frame

COLOR RANGE - pp. 303-310

LAMISTONE CPL	SILKSTONE	SILKSTONE CPL 0.5 mm	UNI MAT PLUS	PAINTED	MONO1 MAT	MONO2 MAT	MONO3 MAT	LAMINATED CPL 0,2 mm	LAMINATED CPL 0,5 mm*	LAMINATED HPL*
VENEERED GROUP A	VENEERED GROUP B	VENEERED GROUP C	VENEERED GROUP D	VENEERED SILKWOOD	VENEERED REALWOOD					

*available for extra charge after consultation with the Sales Department

DOOR OPENING INWARDS ODW



	WIDTH [MM]			HEIGHT [MM]		
	Ss	Sd	So	Hs	Hd	Ho
"60"	625	715	735	1930	1982	1995
"70"	725	815	835	2030 - standard	2082	2095
"80"	825	915	935	2130	2182	2195
"90"	925	1015	1035	2230	2282	2295
"90 plus" *	960	1050	1070	2330	2382	2395
"100"	1025	1115	1135	2430	2482	2495
"110"	1125	1215	1235			

DOOR OPENING OUTWARDS ODZ

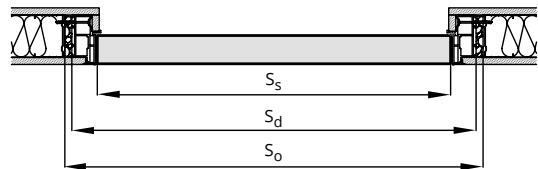

	WIDTH [MM]			HEIGHT [MM]		
	Ss	Sd	So	Hs	Hd	Ho
"60"	625	715	735	1920	1972	1985
"70"	725	815	835	2020 - standard	2072	2085
"80"	825	915	935	2120	2172	2185
"90"	925	1015	1035	2220	2272	2285
"90 plus" *	960	1050	1070	2320	2372	2385
"100"	1025	1115	1135	2420	2472	2485
"110"	1125	1215	1235			

Ss - width of the door leaf
Sd - width of the door on the external side of the door frame
So - width of the installation opening

Hs - height of the door leaf Hd - height of the door on the external side of the door frame
Ho - height of the installation opening

* investment width

INCLUDED IN THE PRICE OF THE DOOR

- The structure of the door leaf consists of a wooden stile and rail reinforced with a steel profile, filled with a special POL-SKONE construction, and a reinforced aluminum door frame. The construction of the door allows it to be flush with the wall surface. The thickness of the door leaf is 50 mm.
- drop seal
- hinges TECTUS TE 340 satin chrome color, strike plate silver color
- door frame painted RAL 9003 - hinges TECTUS TE 340 satin chrome color, strike plate satin chrome color
- door frame painted RAL 9005 - hinges TECTUS TE 340 black color, strike plate black color
- lock magnetic satin chrome for key (spacing 90 mm), for cylinder (spacing 85 mm) or for bathroom lock (spacing 90 mm)

FOR EXTRA CHARGE

- non-standard door sizes p. 296
- color range laminated CPL 0.5 mm ("60"- "90")*
- color range laminated CPL 0.5 mm ("90+"-"110")*
- ventilation undercut** pp. 286-287
- Geze Boxer 2-4 door closer p. 281
- reversible electric strike BIRA XS12R-C + strike plate SPEC 525 + Eco Schulte GBS 12 lock
- non-reversible electric strike BIRA XS12U-C + strike plate SPEC 525 + Eco Schulte GBS 12 lock
- non-reversible electric strike with switch BIRA XS12UW-C + strike plate SPEC 525 + Eco Schulte GBS 12 lock
- door frames in other colors according to the extra charge table p. 311

** doors with heat recovery ventilation cut or ventilation undercut do not have a drop seal or the declared acoustic and air permeability parameters.



HARMONY INVEST PRO

FOR PANEL INSTALLATION

HIDDEN DOORS

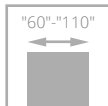

acoustic insulation
Rw = 37 dB

Interior entrance doors intended for rooms in public utility buildings, including offices, hotels, etc.

The construction of the door allows the door leaf to be flush with the surface of the POL-SKONE wall panel (13 mm).

width of doors opening outwards ODZP "60" - "90" **4th class of mechanical strength** according to PN-EN 1192:2001
width of doors opening outwards ODZP "90 plus" - "110" **3rd class of mechanical strength** according to PN-EN 1192:2001
width of doors opening inwards ODWP "60" - "110" **3rd class of mechanical strength** according to PN-EN 1192:2001
acoustic insulation: **Rw= 37 dB, D1-35, D2-30**
National Technical Assessment **ITB-KOT-2022/2187** edition 1

DOOR LEAF AND PANEL HARMONY INVEST PRO

color range	door leaf	panel*
unfinished for self-finishing		
LAMISTONE CPL		
UNI MAT PLUS		
SILKSTONE		
SILKSTONE CPL 0.5 mm		
LAMINATED CPL 0.2 mm		
PAINTED 9003		
MONO1 MAT		
MONO2 MAT		
MONO3 MAT		
VENEERED GROUP A		
VENEERED GROUP B		
VENEERED GROUP C, D		
SILKWOOD / REALWOOD		

* wall panels with a thickness of 13 mm for installation, price per m²

Maximum panel dimensions: width 1100 x height 2500 mm
- extra charge for dimensions 2301 – 2500 mm to the price per m²
- extra charge for dimensions 80 – 299 mm to the price per m²

ATTENTION! For panels with a height of 2200 to 2500 mm, visible veneer joint on micro-dowels

DOOR FRAMES

door leaf width [mm]	625-960	1025-1125	625-960	1025x1125	625-960	1025x1125	625-960	1025-1125	625-960	1025-1125
door leaf height [mm]	2030/2020		2130/2120		2230/2220		2330/2320		2430/2420	
number of hinges	2 pcs.	3 pcs.	3 pcs.	3 pcs.	3 pcs.	3 pcs.	3 pcs.	3 pcs.	3 pcs.	3 pcs.

ODW / ODZ

for self-finishing	PAINTED 9003	MONO1*	MONO2**
--------------------	--------------	--------	---------

extra charge for structural colors

*does not apply to colors NCS S 1002-Y50R, NCS S 1502Y-50R, NCS S 0500-N, NCS S 0502-Y

**does not apply to the NCS palette



HARMONY INVEST PRO door with aluminum door frame

COLOR RANGE – pp. 303-310

LAMISTONE CPL	SILKSTONE	SILKSTONE CPL 0.5 mm	UNI MAT PLUS	MONO1 MAT	MONO2 MAT	LAMINATED CPL 0,2 mm	LAMINATED CPL 0,5 mm*	LAMINATED HPL*
veneered group A	veneered group B	veneered group C	veneered group D	veneered silkwood	veneered realwood	PAINTED	BLACK MATT	*available for extra charge after consultation with the Sales Department

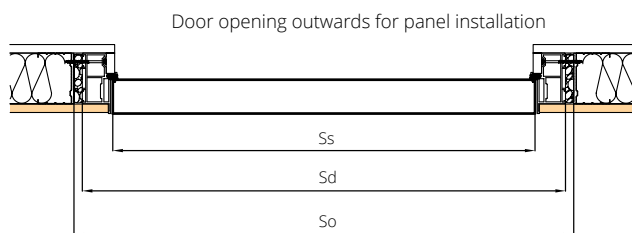
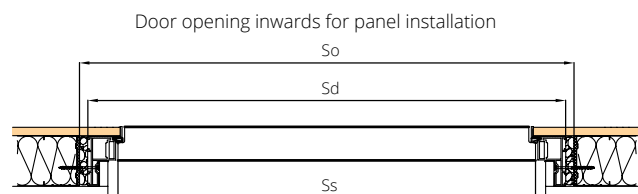

DOOR OPENING INWARDS ODW

WIDTH [MM]	HEIGHT [MM]		
	Ss	Sd	So
"60"	625	715	735
"70"	725	815	835
"80"	825	915	935
"90"	925	1015	1035
"90 plus" *	960	1050	1070
"100"	1025	1115	1135
"110"	1125	1215	1235

DOOR OPENING OUTWARDS ODZ

WIDTH [MM]	HEIGHT [MM]		
	Ss	Sd	So
"60"	625	715	735
"70"	725	815	835
"80"	825	915	935
"90"	925	1015	1035
"90 plus" *	960	1050	1070
"100"	1025	1115	1135
"110"	1125	1215	1235

Ss - width of the door leaf
 Sd - width of the door on the external side of the door frame
 So - width of the installation opening
 Hs - height of the door leaf Hd - height of the door on the external side of the door frame
 Ho - height of the installation opening

* investment width

INCLUDED IN THE PRICE OF THE DOOR

The structure of the door leaf consists of a wooden stile and rail reinforced with a steel profile, filled with a special POL-SKONE construction, and a reinforced aluminum door frame. **The construction of the door allows the door leaf to be flush with the surface of the POL-SKONE wall panel (13 mm).** The thickness of the door leaf is 50 mm.

drop seal

opening outwards: concealed hinges SIMONSWERK type TECTUS TE 541 3D FVZ, 3D adjustable ("60"- "90" – 2 pcs., "100"- "110" – 3 pcs.)

opening inwards: concealed hinges SIMONSWERK type TECTUS TE 240 3D, 3D adjustable ("60"- "110" – 3 pcs.) door higher than standard – 3 pcs.

magnetic lock, satin chrome, for key (spacing 90 mm), for cylinder (spacing 85 mm) or for bathroom lock (spacing 90 mm)

FOR EXTRA CHARGE

non-standard door sizes p. 296

color range laminated CPL 0.5 mm ("60"- "90")*

color range laminated CPL 0.5 mm ("90+"- "110")*

additional TECTUS TE 541 3D hinge, chrome	
additional TECTUS TE 541 3D hinge, white and black	
additional TECTUS TE 240 REVES hinge, silver	
additional TECTUS TE 240 REVES hinge, white or black	
additional TECTUS TE 240 REVES hinge, gold	
change of TE 240 hinge color to black, white	
change of TE 541 hinge color to black, white	
door closers, electric strikes, heat recovery ventilation	pp. 281, 283, 289
ventilation undercut**	pp. 286-287
matched wood grain of wall panels to the door according to the version (matching tolerance up to 10 mm) (extra charge to the price of panels)	

* extra charge for standard door height

** doors with heat recovery ventilation cut or ventilation undercut do not have a drop seal or declared acoustic and air permeability parameters.

- **flexible adjustment of door dimensions to the project**
- **doors available in single-leaf and double-leaf versions**
- **option to expand with top and side lights**
- **a wide selection of 4 mm thick tempered glass panes – clear, white satin, Antisol: grey, dark grey, brown, LINEA: transparent, white satin, MORU**

STEEL DOORS

The collection of steel doors perfectly matches loft and industrial arrangements, where open space and access to natural light are important. Solid construction made of the highest quality steel, large glazing of safe tempered glass, and narrow steel muntins in the color of the door leaf create an elegant and modern design. Complemented with stylish accessories – pull handles or door handles – these doors will also work perfectly in other types of interiors, giving them lightness and a timeless character.



**DEDICATED CATALOG
STEEL DOORS**





GALIO



non-rebated
SYSTEM

"60"- "100"



S1 / VS1



S2 / VS2



S3 / VS3



S5 / VS5



S7 / VS7



S9 / VS9



S10 / VS10



S11 / VS11



S12 / VS12

DOOR FRAMES

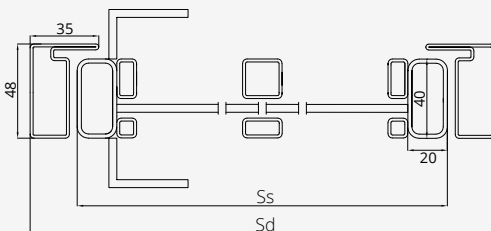

Ss - width of the door leaf
Sd - width on the external side of the door frame
S0 - width of the opening
Hs - height of the door leaf
Hd - height on the external side of the door frame
Ho - height of the opening

single-leaf door

type	S _s	S _d	S ₀
"60"	625	673	680
"70"	725	773	780
"80"	825	873	880
"90"	925	973	980
"90 plus"	965	1013	1020
"100"	1025	1073	1080

standard - Hs - 2040 mm, Hd - 2074 mm, Ho - 2077 mm

non-standard dimensions (not applicable to versions S10, S11, S12) -
consultation with the Technical Department required



GALIO door, version S5, door frame made of closed steel profile



LINEA tempered glass in white satin color, single-sided ornament – for extra charge



standard handle

COLOR RANGE – p. 311

STEEL STRUCTURE GROUP 1

- 0S1** RAL 9003
- 0S2** RAL 9005
- 0S0** anthracite (glitter effect)

STEEL STRUCTURE GROUP 2

- 0S3** copper (glitter effect)
- 0S4** cashmere (glitter effect)
- 0S5** sage
- 0S7** mocha

NEW



Galio hinge

GLAZING

- tempered glass transparent
- tempered glass white matt
- tempered glass Antisol grey
- tempered glass Antisol dark grey
- LINEA tempered glass transparent
- LINEA tempered glass white satin
- NEW** MORU tempered glass

INCLUDED IN THE PRICE OF THE DOOR

The frame of the door leaf is made of the highest quality steel profiles coated with structural powder paint. Metal muntins on the glass, 20 mm wide. The door frame is made of a closed steel profile.

tempered glass with a thickness of 4 mm: transparent, white satin (matt on the hinge side), Antisol grey

two magnets hidden under the gasket of the door frame

hinges of the metal door frame ("60"- "100" – 3 pcs.)

double-sided handle in the form of an angle bar in the color of the door leaf

FOR EXTRA CHARGE

non-standard door dimensions (p. 296)

LINEA tempered glass transparent or white satin with a thickness of 4 mm, single-sided ornament, MORU tempered glass with a thickness of 4 mm

tempered glass Antisol dark grey, brown with a thickness of 4 mm

welded handle in the color of the door leaf, 500 mm long, double-sided

handle 528 mm long, 12 mm diameter, for self-assembly, black or white color

color range	color of hinges	color of the glazing gasket (muntins)	color of screws for the frame	color of the caps in the door frame
0S1 RAL 9003 (white)	in the color of the door leaf	white	white	white
0S2 RAL 9005 (black)	in the color of the door leaf	black	black	black
0S0 anthracite	in the color of the door leaf	black	black	black
0S3 copper 0S4 cashmere 0S5 sage 0S7 mocha	in the color of the door leaf	black	black	black

NEW

LOFT ART

SLIDING SYSTEM

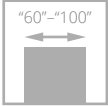

S1 / VS1



S2 / VS2



S3 / VS3



S5 / VS5



S7 / VS7



S9 / VS9



S10 / VS10



S11 / VS11



S12 / VS12

DOOR FRAMES

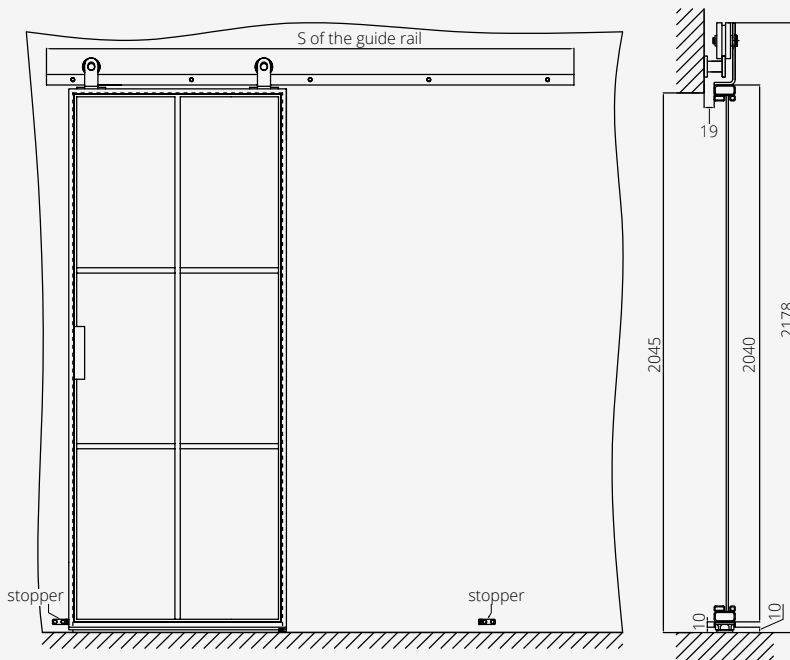

single-leaf door				
type	S_s	S_p	S_o	S of the guide rail
"60"	625	515	595	2000
"70"	725	615	695	2000
"80"	825	715	795	2000
"90"	925	815	895	2500
"100"	1025	915	995	2500

double-leaf door				
type	S_s	S_p	S_o	S of the guide rail
"60"+"60"	2 x 625	1060	1220	2 x 2000
"70"+"70"	2 x 725	1260	1420	2 x 2000
"80"+"80"	2 x 825	1460	1620	2 x 2000
"90"+"90"	2 x 925	1660	1820	2 x 2500
"100"+"100"	2 x 1025	1860	2020	2 x 2500

S_s - width of the door leaf
 S_p - passage width
 S_o - opening width
 S of the guide rail - width of the guide rail

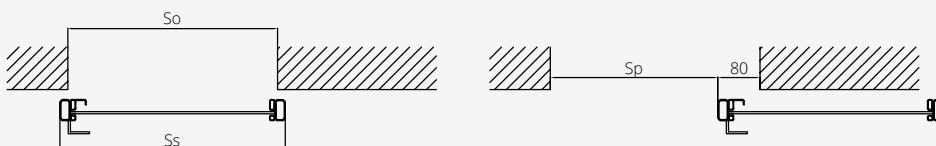



LOFT ART door sliding system, version S1

COLOR RANGE – p. 311

STEEL STRUCTURE GROUP 1	 0S1 RAL 9003	 0S2 RAL 9005	 0S0 anthracite (glitter effect)
	 0S3 copper (glitter effect)	 0S4 cashmere (glitter effect)	 0S5 sage

GLAZING

			
tempered glass transparent	tempered glass white matt	tempered glass Antisol grey	tempered glass Antisol dark grey

SET PRICE
= door leaf version + selected sliding system + soft closer

The LOFT ART wall-mounted sliding system is intended for GALIO door leaves. System without wall casing. Intended for installation on a finished wall.

The frame of the door leaf is made of the highest quality steel profiles coated with structural powder paint. Metal muntins on the glass, 20 mm wide. The door frame is made of a closed steel profile.

tempered glass with a thickness of 4 mm: transparent, white satin (matt on the hinge side), Antisol grey

double-sided handle in the form of an angle bar in the color of the door leaf

sliding system for single-leaf door width "60"- "80" (guide rail length 200 cm)

sliding system for single-leaf door width "90"- "100" (guide rail length 250 cm)

soft closer for one side

sliding system for double-leaf door (width "60"- "80")

sliding system for double-leaf door (width "90"- "100")

soft closer for both sides

NEW

LUMO



non-rebated
SYSTEM

"60"- "100"



S1 / VS1



S2 / VS2



S3 / VS3



S5 / VS5



S7 / VS7



S9 / VS9



S13 / VS13



S14 / VS14



S15 / VS15

DOOR FRAMES

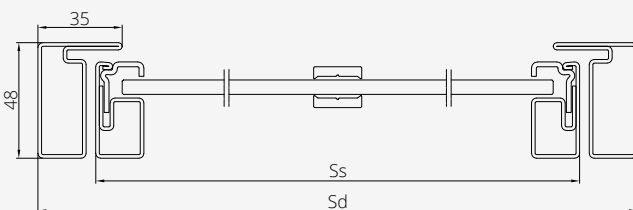

single-leaf door

type	S _s	S _d	S _o
"60"	625	673	680
"70"	725	773	780
"80"	825	873	880
"90"	925	973	980
"90 plus"	965	1013	1020
"100"	1025	1073	1080
standard - H _s - 2040 mm, H _d - 2074 mm, H _o - 2077 mm			
non-standard dimensions (does not apply to versions S14) - consultation with the Technical Department required			



LUMO door, version S13, door frame made of closed steel profile



standard handle



LUMO hinge

COLOR RANGE – p. 311

STEEL STRUCTURE GROUP 1

- 0S1** RAL 9003
- 0S2** RAL 9005
- 0S0** anthracite (glitter effect)

STEEL STRUCTURE GROUP 2

- 0S3** copper (glitter effect)
- 0S4** cashmere (glitter effect)
- 0S5** sage
- 0S7** mocha

NEW



glazing bars glued onto the glass

GLAZING



tempered glass transparent

tempered glass white matt

tempered glass Antisol grey

tempered glass Antisol dark grey



frame without visible screws

INCLUDED IN THE PRICE OF THE DOOR	
The frame of the door leaf is made of the highest quality steel profiles coated with structural powder paint. Frame without screws. Metal glazing bars glued onto the glass, 20 mm wide. The door frame is made of a closed steel profile.	
tempered glass 6 mm thick: transparent, white satin (matte glass on the hinge side), Antisol grey	
two magnets hidden under the gasket of the door frame	
hinges of the metal door frame ("60"- "100" – 3 pcs.)	
double-sided handle in the form of an angle bar in the color of the door leaf	
FOR EXTRA CHARGE	
non-standard door dimensions (p. 296)	
tempered Antisol glass, dark grey, brown, 6 mm thick	
laminated glass VSG 33.1 transparent, white	

color range	color of hinges	color of the caps in the door frame
0S1 RAL 9003 (white)	in the color of the door leaf	white
0S2 RAL 9005 (black)	in the color of the door leaf	black
0S0 anthracite	in the color of the door leaf	black
0S3 copper 0S4 cashmere 0S5 sage 0S7 mocha	in the color of the door leaf	black

GALIO PIVOT

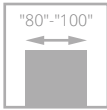

S1 / VS1



S2 / VS2

DOOR FRAMES

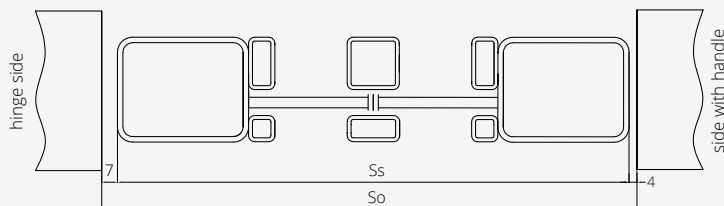

CLOSED DOOR

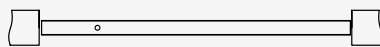

OPENED DOOR

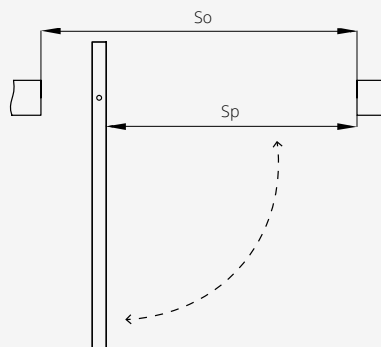

single-leaf door			
type	S _s	S _o	S _p
"80"	885	896	709
"90"	985	996	809
"100"	1085	1096	909
standard – H _s - 2120 mm, H _o - 2139 mm			

S_s – width of the door leaf
 S_o – width of the opening
 S_p – width of the passage opening

H_s – height of the door leaf
 H_o – height of the opening



GALIO PIVOT door, version S1



PIVOT hinge



handle with a length of 500 mm

COLOR RANGE – p. 311

STEEL STRUCTURE GROUP 1	0S1 RAL 9003	0S2 RAL 9005	0S0 anthracite (glitter effect)
	0S3 copper (glitter effect)	0S4 cashmere (glitter effect)	0S5 sage
STEEL STRUCTURE GROUP 2			NEW 0S7 mocha

GLAZING

tempered glass transparent	tempered glass white matt	tempered glass Antisol grey	tempered glass Antisol dark grey
LINEA tempered glass transparent 4 mm	LINEA tempered glass white satin	MORU tempered glass	

INCLUDED IN THE PRICE OF THE DOOR
The frame of the door leaf is made of the highest quality steel profiles coated with structural powder paint. Metal muntins on glass with a width of 20 mm. Thanks to the use of the PIVOT hinge, the door can be opened both outwards and inwards. The door leaf automatically locks at a 90° position, and the hinge enables automatic closing of the door leaf up to the closing point. The door operates in a frameless system.
tempered glass with a thickness of 4 mm: transparent, white satin (matt on the hinge side), Antisol grey
hinge PIVOT
welded handle in the color of the door leaf, 500 mm long, double-sided

FOR EXTRA CHARGE
non-standard door dimensions (p. 296)
LINEA tempered glass transparent or white satin with a thickness of 4 mm, single-sided ornament, MORU tempered glass with a thickness of 4 mm
tempered glass Antisol dark grey, brown with a thickness of 4 mm
handle with a length of 528 mm, diameter 12 mm, for self-assembly, black or white color
without extra charge

GALIO

DOUBLE-LEAF DOOR

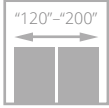

S1 / VS1



S2 / VS2



S3 / VS3



S5 / VS5



S7 / VS7



S9 / VS9



S10 / VS10



S11 / VS11



S12 / VS12

DOOR FRAMES

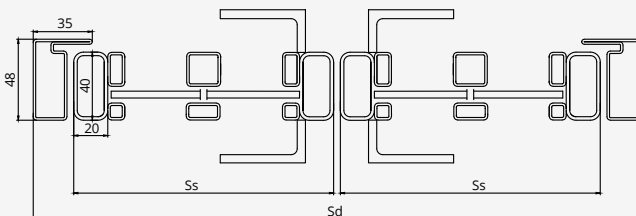

double-leaf door			
type	S _s	S _d	S _o
"60"+"60"	625 + 625	1304	1310
"70"+"70"	725 + 725	1504	1510
"80"+"80"	825 + 825	1704	1710
"90"+"90"	925 + 925	1904	1910
"100"+"100"	1025 + 1025	2104	2110
standard – H _s - 2040 mm, H _d - 2074 mm, H _o - 2077 mm			
non-standard dimensions (does not apply to versions S10, S11, S12) – consultation with the Technical Department required			



GALIO double-leaf door, version S1, door frame made of closed steel profile



LINEA tempered glass in white satin color, single-sided ornament – for extra charge



double-sided handle in the form of an angle bar

COLOR RANGE – p. 311

STEEL STRUCTURE GROUP 1

- 0S1** RAL 9003
- 0S2** RAL 9005
- 0S0** anthracite (glitter effect)

STEEL STRUCTURE GROUP 2

- 0S3** copper (glitter effect)
- 0S4** cashmere (glitter effect)
- 0S5** sage
- NEW 0S7** mocha



Galio hinge

GLAZING

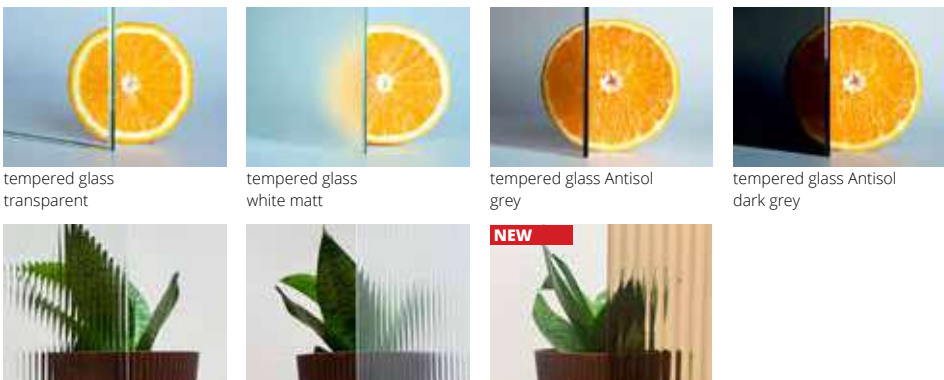

tempered glass transparent tempered glass white matt tempered glass Antisol grey tempered glass Antisol dark grey

LINEA tempered glass transparent LINEA tempered glass white satin MORU tempered glass

INCLUDED IN THE PRICE OF THE DOOR

The frame of the door leaf is made of the highest quality steel profiles coated with structural powder paint. Metal muntins on the glass, 20 mm wide. The door frame is made of a closed steel profile.

symmetrical division of door leaves

double-sided handle in the form of an angle bar in both door leaves, in the color of the door leaves

independent opening of door leaves using two handles

tempered glass with a thickness of 4 mm: transparent, white satin (matt on the hinge side), Antisol grey

two magnets hidden under the gasket of the door frame

hinges of the metal door frame ("60"×"60"-100"×"100" – 6 pcs.)

FOR EXTRA CHARGE

non-standard door dimensions (p. 296)

LINEA tempered glass transparent or white satin with a thickness of 4 mm, single-sided ornament, MORU tempered glass with a thickness of 4 mm

tempered glass Antisol dark grey, brown with a thickness of 4 mm

asymmetrical division of door leaves on request

welded handle in the color of the door leaf with a length of 500 mm, double-sided (1 pc.)

handle with a length of 528 mm, diameter 12 mm, for self-assembly, black or white color (1 pc.)

color range	color of hinges	color of the glazing gasket (muntins)	color of screws for the frame	color of the caps in the door frame
0S1 RAL 9003 (white)	in the color of the door leaf	white	white	white
0S2 RAL 9005 (black)	in the color of the door leaf	black	black	black
0S0 anthracite	in the color of the door leaf	black	black	black
0S3 copper 0S4 cashmere 0S5 sage 0S7 mocha	in the color of the door leaf	black	black	black

NEW

LUMO

DOUBLE-LEAF DOOR

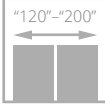

S1 / VS1



S2 / VS2



S3 / VS3



S5 / VS5



S7 / VS7



S9 / VS9



S13 / VS13



S14 / VS14



S15 / VS15

DOOR FRAMES

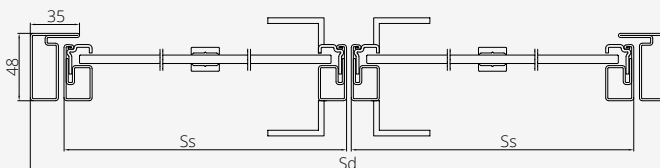

double-leaf door			
type	S _s	S _d	S _o
"60"+"60"	625 + 625	1304	1310
"70"+"70"	725 + 725	1504	1510
"80"+"80"	825 + 825	1704	1710
"90"+"90"	925 + 925	1904	1910
"100"+"100"	1025 + 1025	2104	2110
standard – H _s - 2040 mm, H _d - 2074 mm, H _o - 2077 mm			
non-standard dimensions (does not apply to versions S10, S11, S12) – consultation with the Technical Department required			



LUMO double-leaf door, version S9, door frame made of closed steel profile



standard handle



LUMO hinge

COLOR RANGE – p. 311

STEEL STRUCTURE GROUP 1

- 0S1**
RAL 9003
- 0S2**
RAL 9005
- 0S0**
anthracite
(glitter effect)

STEEL STRUCTURE GROUP 2

- 0S3**
copper
(glitter effect)
- 0S4**
cashmere
(glitter effect)
- 0S5**
sage
- NEW**
0S7
mocha



glazing bars glued onto the glass

GLAZING

tempered glass transparent

tempered glass white matt

tempered glass Antisol grey

tempered glass Antisol dark grey



frame without visible screws

INCLUDED IN THE PRICE OF THE DOOR

The frame of the door leaf is made of the highest quality steel profiles coated with structural powder paint. Frame without screws. Metal glazing bars glued onto the glass, 20 mm wide. The door frame is made of a closed steel profile.

tempered glass with a thickness of 6 mm: transparent, white satin (matt glass on the hinge side), Antisol grey

two magnets hidden under the gasket of the door frame

hinges of the metal door frame ("60"-100" – 3 pcs.)

double-sided handle in the form of an angle bar in the color of the door leaf

FOR EXTRA CHARGE

non-standard door dimensions (p. 296)

tempered Antisol glass, dark grey, brown, 6 mm thick

laminated glass VSG 33.1 transparent, white

color range	color of hinges	color of the caps in the door frame
0S1 RAL 9003 (white)	in the color of the door leaf	white
0S2 RAL 9005 (black)	in the color of the door leaf	black
0S0 anthracite	in the color of the door leaf	black
0S3 copper 0S4 cashmere 0S5 sage 0S7 mocha	in the color of the door leaf	black

STALIO



non-rebated
SYSTEM

"60"- "100"



S1 / VS1



S2 / VS2

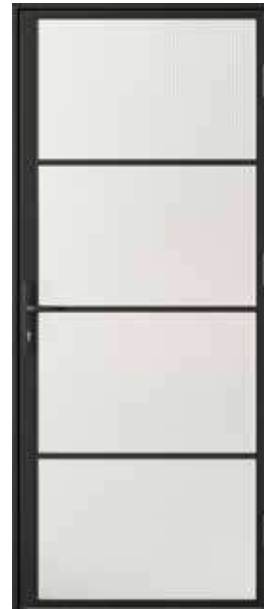

S3 / VS3



S5 / VS5



S7 / VS7



S9 / VS9

DOOR FRAMES

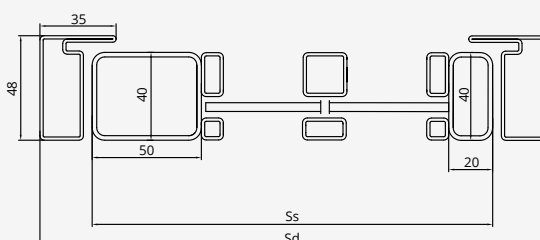

DIMENSIONS

width	S _s	S _d	S _o
"60"	625	676	682
"70"	725	776	782
"80"	825	876	882
"90"	925	976	982
"90 PLUS"	965	1016	1022
"100"	1025	1076	1082
standard - H _s - 2040 mm, H _d - 2074 mm, H _o - 2077 mm			
non-standard dimensions - consultation with the Technical Department required			



STALIO door, version S7, door frame made of closed steel profile



LINEA tempered glass in white satin color, single-sided ornament – for extra charge



hinge



WB lock with handle

COLOR RANGE – p. 311

STEEL STRUCTURE GROUP 1

- 0S1** RAL 9003
- 0S2** RAL 9005
- 0S0** anthracite (glitter effect)

STEEL STRUCTURE GROUP 2

- 0S3** copper (glitter effect)
- 0S4** cashmere (glitter effect)
- 0S5** sage
- NEW 0S7** mocha

GLAZING

- tempered glass transparent
- tempered glass white matt
- tempered glass Antisol grey
- tempered glass Antisol dark grey
- LINEA tempered glass transparent
- LINEA tempered glass white satin
- NEW** MORU tempered glass

INCLUDED IN THE PRICE OF THE DOOR

The frame of the door leaf is made of the highest quality steel profiles coated with structural powder paint. Metal muntins on the glass, 20 mm wide. The door frame is made of a closed steel profile.

tempered glass with a thickness of 4 mm: transparent, white satin (matt on the hinge side), Antisol grey

WB lock with handle on a long escutcheon

hinges of the metal door frame ("60"- "100" – 3 pcs.)

FOR EXTRA CHARGE

non-standard door dimensions (p. 296)

LINEA tempered glass, transparent or white satin, 4 mm thick, single-sided ornament, MORU tempered glass, 4 mm thick

tempered glass Antisol dark grey, brown with a thickness of 4 mm

insert 30/30 spacing, silver

color range	color of hinges	color of the glazing gasket (muntins)	color of screws for the frame	color of the caps in the door frame
0S1 RAL 9003 (white)	in the color of the door leaf	white	white	white
0S2 RAL 9005 (black)	in the color of the door leaf	black	black	black
0S0 anthracite	in the color of the door leaf	black	black	black
0S3 copper 0S4 cashmere 0S5 sage 0S7 mocha	in the color of the door leaf	black	black	black

GALIO / STALIO

TOP AND SIDE LIGHTS
side/top



non-rebated
SYSTEM

"60"- "100"

"120"- "200"



VERSION

PRICE OF TOP AND SIDE LIGHT = PRICE PER 1 m.b. x 2(A+B)
+ PRICE PER 1 m² OF GLASS x A x B

1 m.b. OF TOP AND SIDE LIGHT

1 m² OF GLASS:

tempered glass 4 mm transparent

tempered glass 4 mm white satin (matt on the hinge side)

antisol glass grey

antisol glass dark grey, brown

Linea glass white satin or transparent

Moru glass

DOOR FRAMES

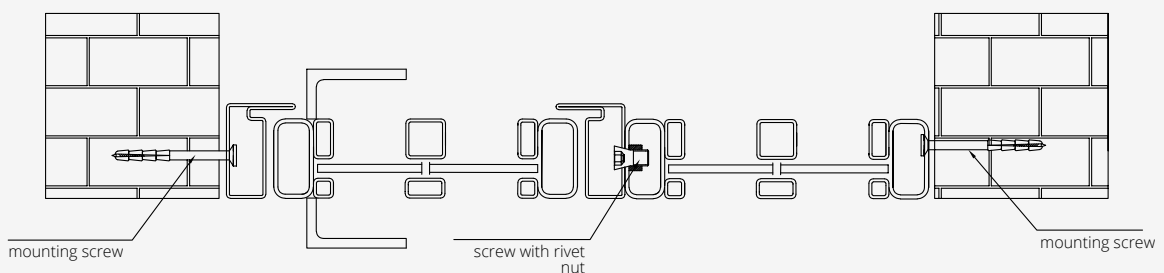



GALIO door with side and top top and side lights

GLAZING



tempered glass transparent



tempered glass white matt



tempered glass Antisol grey



tempered glass Antisol dark grey



LINEA tempered glass transparent



LINEA tempered glass white satin



MORU tempered glass

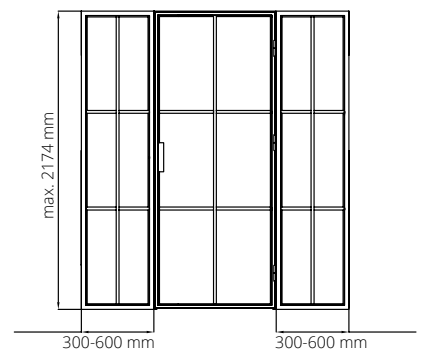
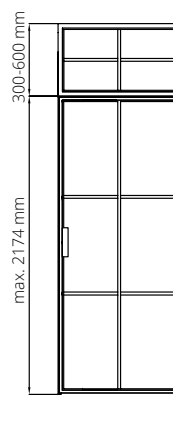
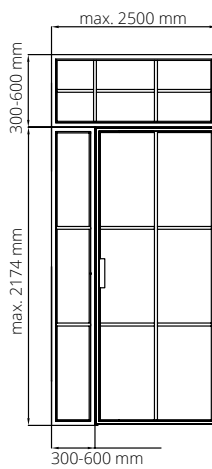
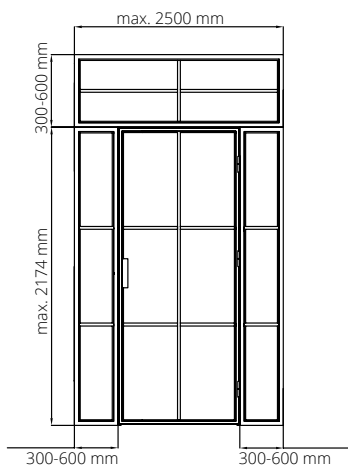

Arrangement/spacing of muntins in top and side lights after consultation with the Sales Department

INCLUDED IN THE PRICE

The frame of the top and side lights is made of the highest quality steel profiles coated with structural powder paint. Metal structural muntins on the glass, 20 mm wide.

maximum height of the side top and side light – 2174 mm

minimum width of the top and side light – 300 mm

in double-leaf doors, it is not possible to combine side top and side lights with upper ones

- **modern or classic**
- **wide color range of veneers, laminates and veneers**
- **rich color range of RAL and NCS**
- **wooden, panel or stile and rail type**
- **rebated, hidden, non-rebated system, reverse rebate, sliding systems**

INTERIOR DOORS

Interior doors are manufactured based on high-quality constructions and fillings, which allows them to meet the requirements of Clients and adapt to their needs. Classic doors or modern doors? The range of interior doors includes over 450 versions of doors, including stylish profiled doors, smooth, with glass or decorations.





VISIO



DOOR OPENED WITH A DEDICATED HANDLE

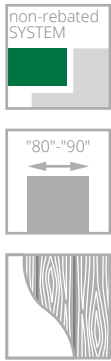

W01



W02



W03



W04



W05



W01S6



W01S8

DOOR FRAMES



fixed DUO



adjustable
DIN DUO



adjustable
DIN DUO SOLID



VISIO door, version W03, adjustable DIN DUO door frame

COLOR RANGE – pp. 303-310

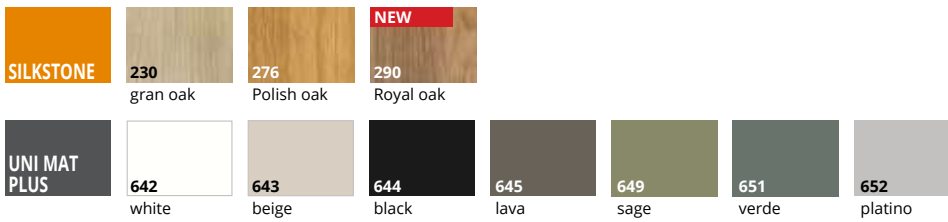

PURE handle



LIEVE handle



handle satin chrome white black gold

PURE

LIEVE

INCLUDED IN THE PRICE OF THE DOOR

Solid construction made of a wooden stile and rail from laminated wood. Vertical and horizontal stile and rail elements with a thickness of 40 mm and a width of 80 mm. Muntins in the color of the door leaf or black.

muntins with a width of 20 mm in the color of the door leaf or black – versions W01S6, W01S8, W04, W05

muntins with a width of 45 mm in the color of the door leaf or black – versions W02, W03

tempered glass, white matt or transparent, with a thickness of 6 mm

NON-REBATED SYSTEM

concealed hinge, satin nickel "80"- "90" – 3 pcs.

magnetic lock, satin nickel, without keyhole

color 644 black – black hinges and lock

color 642 white – white hinges and lock

FOR EXTRA CHARGE

non-standard door sizes p. 296

Antisol brown tempered glass with a thickness of 6 mm

dedicated PURE and LIEVE handles

NON-REBATED SYSTEM

change of hinge color to white or black

change of hinge color to gold

change of magnetic lock color to white, black or gold

NEW

VISIO LUX

DOOR OPENED WITH A DEDICATED HANDLE

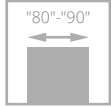

W01



W02



W03



W04



W05



W01S6



W01S8

DOOR FRAMES



fixed DUO



adjustable
DIN DUO









adjustable
DIN DUO SOLID



VISIO LUX door, version W02, adjustable DIN DUO door frame

COLOR RANGE – pp. 303-310

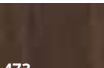
VENEERED GROUP A				
	334 European oak			
VENEERED GROUP D				
	NEW 461 caramel oak	NEW 462 truffle oak	NEW 463 chocolate oak	
VENEERED REALWOOD				
	470 nabucco matt	471 tosca matt	472 traviata matt	473 kastano matt

PURE handle



NEW
handle without
rosette

LIEVE handle



NEW
handle without
rosette

handle satin chrome white black gold

PURE

LIEVE

INCLUDED IN THE PRICE OF THE DOOR

Solid construction made of oak wood, covered with natural veneer, rounded edges. Vertical and horizontal stile and rails with a thickness of 40 mm and a width of 80 mm. Muntins in the color of the door leaf. REALWOOD - veneer covered with ultra-matt UV lacquer with visible wood grain. SILKWOOD - veneer painted with ecological paints from the RAL and NCS palettes.

muntins with a width of 20 mm in the color of the door leaf or black - versions W01S6, W01S8, W04, W05

muntins with a width of 45 mm in the color of the door leaf or black - versions W02, W03

tempered glass, white matt or transparent, with a thickness of 6 mm

NON-REBATED SYSTEM

concealed hinge, satin nickel "80"- "90" – 3 pcs.

magnetic lock, satin nickel, without keyhole

FOR EXTRA CHARGE

non-standard door sizes p. 296

Antisol brown tempered glass with a thickness of 6 mm

PURE and LIEVE handle

NON-REBATED SYSTEM

change of hinge color to white or black

change of hinge color to gold

change of magnetic lock color to white, black or gold

NEW

VISIO M

DOOR OPENED WITH A DEDICATED HANDLE

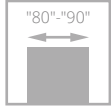

W01



W02



W03

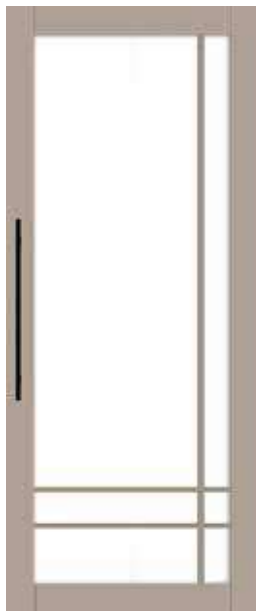

W04

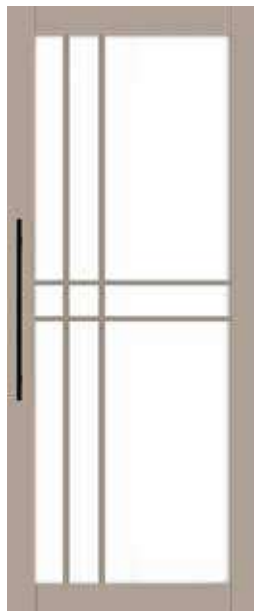

W05



01S6

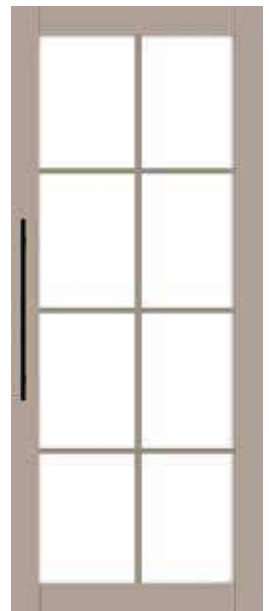

01S8

DOOR FRAMES



fixed DUO



adjustable
DIN DUO



adjustable
DIN DUO SOLID



VISIO M door, version 01S8, adjustable DIN DUO door frame



white handle





















silver handle



black handle

COLOR RANGE - pp. 303-310

SILKSTONE	 230 gran oak	 276 Polish oak	 NEW 290 Royal oak				
	 642 white	 643 beige	 644 black	 645 lava	 649 sage	 651 verde	 652 platino
	 334 European oak						
VENEERED GROUP A							
	 NEW 461 caramel oak	 NEW 462 truffle oak	 NEW 463 chocolate oak				
VENEERED REALWOOD	 470 nabucco matt	 471 tosca matt	 472 traviata matt	 473 kastano matt			

INCLUDED IN THE PRICE OF THE DOOR

Solid construction made of a wooden stile and rail from laminated wood. Vertical and horizontal stile and rail elements with a thickness of 40 mm and a width of 80 mm. Muntins in the color of the door leaf or black.

muntins with a width of 20 mm in the color of the door leaf or black - versions W01S6, W01S8, W04, W05

muntins with a width of 45 mm in the color of the door leaf or black - versions W02, W03

tempered glass, white matt or transparent, with a thickness of 6 mm

double-sided handle, length 530 mm and diameter 12 mm, satin chrome, black, white

NON-REBATED SYSTEM

concealed hinge, satin nickel "80"- "90" - 3 pcs.

magnetic catches in the door leaf and door frame

FOR EXTRA CHARGE

non-standard door sizes p. 296

Antisol brown tempered glass with a thickness of 6 mm

NON-REBATED SYSTEM

change of hinge color to white or black

NEW

VISIO M double-leaf door

DOOR OPENED WITH A DEDICATED HANDLE

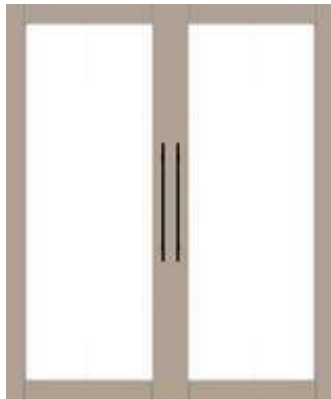

W01

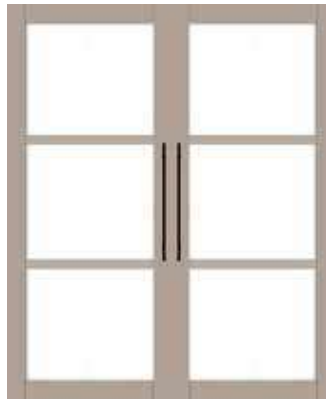

W02

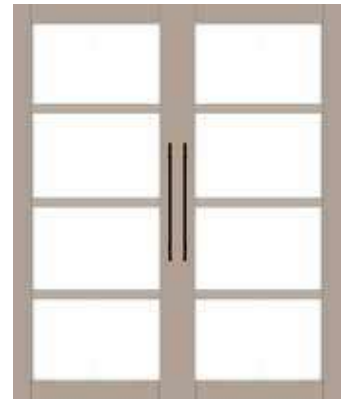

W03

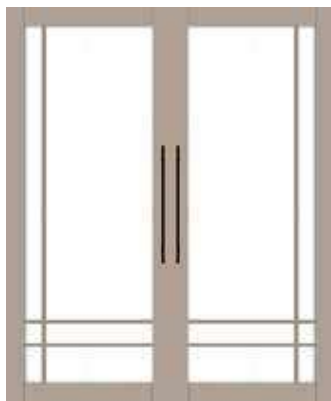

W04

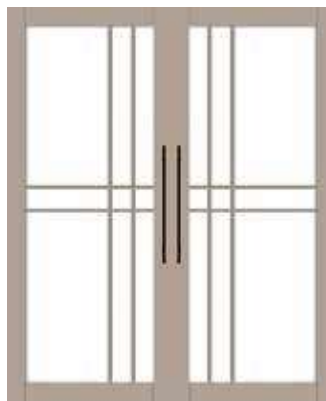

W05

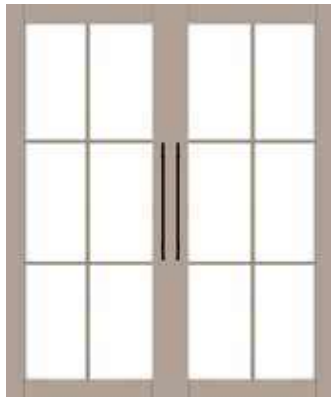

W01S6

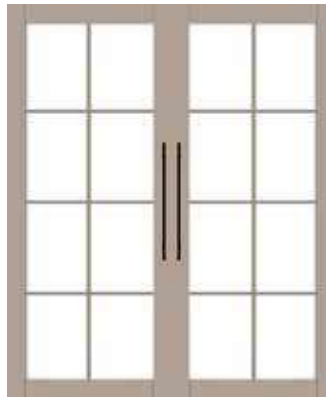

W01S8

DOOR FRAMES



fixed DUO



adjustable
DIN DUO



adjustable
DIN DUO SOLID



VISIO M DOUBLE-LEAF DOOR, version W01S6, adjustable DIN DUO door frame



white handle



















silver handle



black handle

COLOR RANGE – pp. 303-310

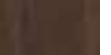
SILKSTONE	 230 gran oak	 276 Polish oak	 NEW 290 Royal oak				
	 642 white	 643 beige	 644 black	 645 lava	 649 sage	 651 verde	 652 platino
	 VENEERED GROUP A 334 European oak						
VENEERED GROUP D	 NEW 461 caramel oak	 NEW 462 truffle oak	 NEW 463 chocolate oak				
	 VENEERED REALWOOD 470 nabucco matt	 471 tosca matt	 472 traviata matt	 473 kastano matt			

INCLUDED IN THE PRICE OF THE DOOR

Solid construction made of a wooden stile and rail from laminated wood. Vertical and horizontal stile and rail elements with a thickness of 40 mm and a width of 80 mm. Muntins in the color of the door leaf or black.

muntins with a width of 20 mm in the color of the door leaf or black – versions W01S6, W01S8, W04, W05

muntins with a width of 45 mm in the color of the door leaf or black – versions W02, W03

tempered glass, white matt or transparent, with a thickness of 6 mm

double-sided handle, length 530 mm and diameter 12 mm, satin chrome, black, white

NON-REBATED SYSTEM

concealed hinge, satin nickel "80"- "90" – 3 pcs.

magnetic catches in the door leaf and door frame

FOR EXTRA CHARGE

non-standard door sizes

p. 296

Antisol brown tempered glass with a thickness of 6 mm

NON-REBATED SYSTEM

change of hinge color to white or black

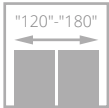
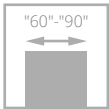

for door leaves with ventilation option



regarding door leaves with ventilation undercut



W00 / V01



W01S8 / V1S8



W01S8 black muntins



W01 / V1SD



W02 / V02



W03 / V03



W04 / V04



WLZ | WLA/Z

NEW VERSION

mirror*

* WLZ - mirror on the hinge side

WLA/Z - mirror on the side opposite to the hinge

DOOR FRAMES



fixed POL-SKONE system



adjustable DIN system



fixed metal



adjustable metal



adjustable AQUA DIN



adjustable DIN DUO



fixed metal



adjustable metal



adjustable AQUA DIN DUO



SEDO door, version W03, adjustable DIN door frame



muntin profile



LINEA tempered glass

COLOR RANGE – pp. 303-310

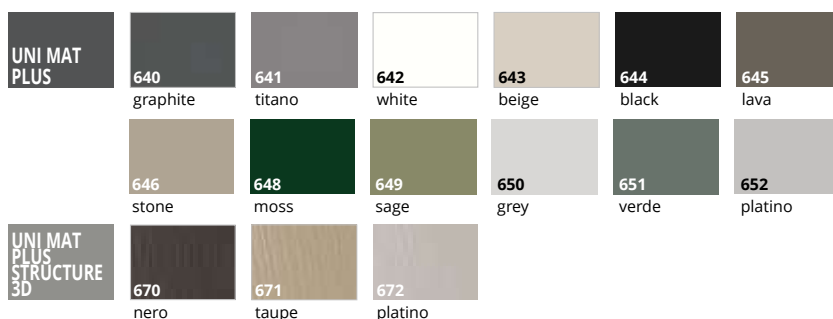

beveling of the edges at the stile and rail joints



mirror



MORU glass

INCLUDED IN THE PRICE OF THE DOOR
Stile and rails made of high-quality MDF (vertical and horizontal, 40 mm thick), muntins in the color of the door leaf or black. The UNI MAT PLUS surface, UNI MAT PLUS 3D STRUCTURE are characterized by a silky touch and a special coating resistant to fingerprints.
version W00, W02, W03, W04: panel 12 mm thick; version W01, W01S8: clear tempered glass or white matt glass 4 mm thick; laminated glass VSG 22.1, VSG 33.1 cannot be used
REBATED SYSTEM
visible hinge, silver galvanized "60"- "90" – 3 pcs.
type B – for DIN door frame system, type D – for wooden door frame, type M – for metal door frame
silver latch-bolt lock: for key, cylinder, bathroom lock, without keyhole
NON-REBATED SYSTEM
concealed hinge, satin nickel "60"- "90" – 3 pcs.
magnetic lock, satin chrome: for key, cylinder, bathroom lock, without keyhole

FOR EXTRA CHARGE	
non-standard door sizes	p. 296
clear Linea glass, 4 mm thick, single-sided ornament	
MORU tempered glass, 4 mm thick	
door closers, electric strikes	pp. 281, 283
drop seal	
heat recovery ventilation (applies to doors of standard height)	
ventilation undercut	
sliding systems	pp. 168-177

VERI

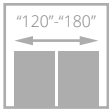
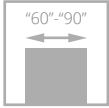

for door leaves with ventilation option



regarding door leaves with ventilation undercut



W00 / V01



W01 / V1SD



**NEW
VERSION**

V1SP



W02 / V02



W03 / V03



W04 / V04

DOOR FRAMES



adjustable
DIN system



fixed metal



adjustable metal



adjustable
AQUA DIN



adjustable
REVES system



adjustable
DIN DUO



fixed metal



adjustable metal



adjustable
AQUA DIN DUO



VERI door, version W00, adjustable DIN DUO door frame



frame profile



bevel at the stile and rail joints

COLOR RANGE – pp. 303-310

UNI MAT PLUS	640 graphite	641 titano	642 white	643 beige	644 black
	645 lava	646 stone	648 moss	649 sage	
	650 grey	651 verde	652 platino		
UNI MAT PLUS STRUCTURE 3D	670 nero	671 taupe	672 platino		

DECORATIVE OVERLAY

for DIN, DIN DUO and REVES door frames



Color range UNI MAT PLUS, LAMISTONE, SILKSTONE
Mouldings for self-cutting at a 45° angle



panel with finished edge glued to the glass – version V1SP

INCLUDED IN THE PRICE OF THE DOOR

Stile and rails made of high-quality MDF (vertical and horizontal, 40 mm thick), panel (12 mm thick). The surface of UNI MAT PLUS and UNI MAT PLUS STRUCTURE 3D is characterized by a silky haptic feel and a special coating resistant to fingerprints.

spatial decorative frame

tempered glass white matt with a thickness of 4 mm (version W01)

double-sided HDF panel in the color range of the door leaf with a thickness of 3.5 mm, edges protected (version V1SP)

REBATED SYSTEM

visible hinge, silver galvanized “60”-“90” – 3 pcs.

type B - for door frame DIN system,

type M - for metal door frame

silver latch-bolt lock: for key, cylinder, bathroom lock, without keyhole

NON-REBATED SYSTEM

concealed hinge, satin nickel “60”-“90” – 3 pcs.

magnetic lock, satin chrome: for key, cylinder, bathroom lock, without keyhole

FOR EXTRA CHARGE

non-standard door sizes

p. 296

tempered transparent glass with a thickness of 4 mm

tempered Antisol grey glass (version V1SP)

tempered Antisol dark grey, brown glass (version V1SP)

laminated glass VSG 22.1 in black color (version W01, V1SP)

laminated glass VSG 22.1 in white color (version W01, V1SP)

it is not possible to use laminated glass VSG 33.1

REBATED SYSTEM

change of lock color to black

NON-REBATED SYSTEM

change of hinge color to white or black

change of hinge color to gold

change of magnetic lock color to white, black or gold

non-rebated lock with latch (silver, white, black or gold) - **NEW**

REVES SYSTEM (reverse rebate) - number of hinges

“60”-“80” - 2 pcs, “90” - 3 pcs.

additional concealed TE hinge, silver

change of TE hinge color to white or black

change of TE hinge color to gold

door closers, electric strikes

pp. 281, 283

drop seal

heat recovery ventilation (applies to doors of standard height)

ventilation undercut

sliding systems

pp. 168-177

MODO

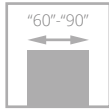

for door leaves with ventilation option



regarding door leaves with ventilation undercut



W00 / V01



W01 / V1SD



V1SP



W02 / V02



W03 / V03



W04 / V04

DOOR FRAMES



adjustable
DIN system



fixed metal



adjustable metal



adjustable
AQUA DIN



adjustable
REVES system



adjustable
DIN DUO



fixed metal



adjustable metal



adjustable
AQUA DIN DUO



MODO door, version W00, adjustable DIN door frame



frame profile



panel with finished edge glued to the glass – version V1SP

COLOR RANGE – pp. 303-310

UNI MAT PLUS	640 graphite	641 titano	642 white	643 beige	644 black
	645 lava	646 stone	648 moss	649 sage	
	650 grey	651 verde	652 platino		
UNI MAT PLUS STRUCTURE 3D	670 nero	671 taupe	672 platino		

DECORATIVE OVERLAY

for DIN, DIN DUO and REVES door frames



Color range UNI MAT PLUS, LAMISTONE, SILKSTONE

Mouldings for self-cutting at a 45° angle

INCLUDED IN THE PRICE OF THE DOOR

Stile and rails made of high-quality MDF (vertical and horizontal, 40 mm thick), panel (12 mm thick). The surface of UNI MAT PLUS and UNI MAT PLUS STRUCTURE 3D is characterized by a silky haptic feel and a special coating resistant to fingerprints.

spatial decorative frame

tempered glass white matt with a thickness of 4 mm (version W01)

double-sided HDF panel in the color range of the door leaf with a thickness of 3.5 mm, edges protected (version V1SP)

REBATED SYSTEM

visible hinge, silver galvanized "60"- "90" – 3 pcs.

type B - for door frame DIN system,

type M - for metal door frame

silver latch-bolt lock: for key, cylinder, bathroom lock, without keyhole

NON-REBATED SYSTEM

concealed hinge, satin nickel "60"- "90" – 3 pcs.

magnetic lock, satin chrome: for key, cylinder, bathroom lock, without keyhole

FOR EXTRA CHARGE

non-standard door sizes p. 296

tempered transparent glass with a thickness of 4 mm

tempered Antisol grey glass (version V1SP)

tempered Antisol dark grey, brown glass (version V1SP)

laminated glass VSG 22.1 in black color (version W01, V1SP)

laminated glass VSG 22.1 in white color (version W01, V1SP)

it is not possible to use laminated glass VSG 33.1

REBATED SYSTEM

change of lock color to black

NON-REBATED SYSTEM

change of hinge color to white or black

change of hinge color to gold

change of magnetic lock color to white, black or gold

non-rebated lock with latch (silver, white, black or gold) - **NEW**

REVES SYSTEM (reverse rebate) - number of hinges

"60"- "80" - 2 pcs, "90" - 3 pcs.

additional concealed TE hinge, silver

change of TE hinge color to white or black

change of TE hinge color to gold

door closers, electric strikes pp. 281, 283

drop seal

heat recovery ventilation (applies to doors of standard height)

ventilation undercut

sliding systems pp. 168-177

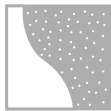
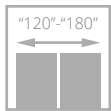
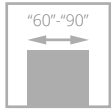

for door leaves with ventilation option



regarding door leaves with undercut



W00 / V01



W01 / V1SD



W02 / V02



W03 / V2SD



W04 / V03



W05 / V3SD

DOOR FRAMES



adjustable
DIN system



fixed metal



adjustable metal



adjustable
AQUA DIN



adjustable
REVES system



adjustable
DIN DUO



fixed metal



adjustable metal



adjustable
AQUA DIN DUO



EGRO door, version W00, adjustable DIN DUO door frame



spatial panel



LINEA tempered glass



connection of vertical stile and rail with horizontal stile and rail

COLOR RANGE – pp. 303-310

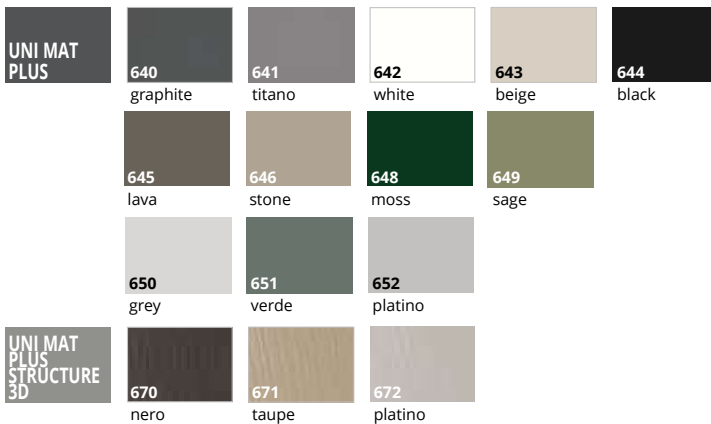

INCLUDED IN THE PRICE OF THE DOOR

Stile and rails made of high-quality MDF (vertical and horizontal, 40 mm thick), spatial panel made of MDF (16 mm thick). The surface of UNI MAT PLUS and UNI MAT PLUS STRUCTURE 3D is characterized by a silky haptic feel and a special coating resistant to fingerprints.

tempered glass white matt with a thickness of 4 mm

REBATED SYSTEM

visible hinge, silver galvanized "60"- "90" – 3 pcs.

type B - for door frame DIN system,

type M - for metal door frame

silver latch-bolt lock: for key, cylinder, bathroom lock, without keyhole

NON-REBATED SYSTEM

concealed hinge, satin nickel "60"- "90" – 3 pcs.

magnetic lock, satin chrome: for key, cylinder, bathroom lock, without keyhole

FOR EXTRA CHARGE

non-standard door sizes p. 296

tempered transparent glass with a thickness of 4 mm

tempered LINEA transparent glass with a thickness of 4 mm, single-sided ornament

MORU tempered glass, 4 mm thick

it is not possible to use laminated glass VSG 33.1

REBATED SYSTEM

change of lock color to black

NON-REBATED SYSTEM

change of hinge color to white or black

change of hinge color to gold

change of magnetic lock color to white, black or gold

non-rebated lock with latch (silver, white, black or gold) - **NEW**

REVES SYSTEM (reverse rebate) - number of hinges

"60"- "80" - 2 pcs, "90" - 3 pcs.

additional concealed TE hinge, silver

change of TE hinge color to white or black

change of TE hinge color to gold

door closers, electric strikes pp. 281, 283

drop seal

heat recovery ventilation (applies to doors of standard height)

ventilation undercut

sliding systems pp. 168-177

heat recovery ventilation (applies to doors of standard height)

ventilation undercut

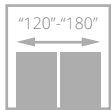
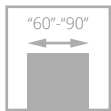

regarding door leaves with ventilation undercut



V03



V3S1



V3S2



V3S3



V3S4



V3S5

DOOR FRAMES



fixed POL-SKONE system



adjustable DIN system



fixed metal



adjustable metal



adjustable AQUA DIN



adjustable DIN DUO



fixed metal



adjustable metal



adjustable AQUA DIN DUO



ESTO door, version V3S5, adjustable DIN door frame

COLOR RANGE - pp. 303-310

LAMISTONE CPL						
	213 super white	231 Halif oak	250 Terra oak	289 grey		
	SILKSTONE					
		230 gran oak	276 Polish oak	290 Royal oak		
NEW						
UNI MAT PLUS						
	640 graphite	641 titano	642 white	643 beige	645 lava	646 stone

INCLUDED IN THE PRICE OF THE DOOR

Stile and rails made of high-quality MDF (vertical 40 mm thick and horizontal 35 mm thick), panels made of MDF (22 mm thick). The surface of UNI MAT PLUS is characterized by a silky haptic feel and a special coating resistant to fingerprints.

white matt glass with a thickness of 4 mm

REBATED SYSTEM

visible hinge, silver galvanized "60"- "90" - 3 pcs.
 type B - for DIN door frame system,
 type D - for wooden door frame,
 type M - for metal door frame
 silver latch-bolt lock: for key, cylinder, bathroom lock, without keyhole

NON-REBATED SYSTEM

concealed hinge, satin nickel "60"- "90" - 3 pcs.
 magnetic lock, satin chrome: for key, cylinder, bathroom lock, without keyhole

FOR EXTRA CHARGE

non-standard door sizes p. 296
 tempered transparent glass with a thickness of 4 mm
 laminated glass VSG 22.1 black color (applies to 1 pane)
 it is not possible to use laminated glass VSG 33.1
 door closers, electric strikes pp. 281, 283
 drop seal
 heat recovery ventilation (applies to doors of standard height)
 ventilation undercut
 sliding systems pp. 168-177

REBATED SYSTEM

change of lock color to black

NON-REBATED SYSTEM

change of hinge color to white or black
 change of hinge color to gold
 change of magnetic lock color to white, black or gold
 non-rebated lock with latch (silver, white, black or gold) - **NEW**

ARCO

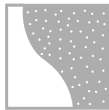
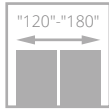
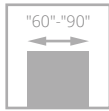

regarding door leaves with ventilation undercut



W02P / V02



W2S / V2S2



W02 / V2S5



W2D / V1SD



W03P / V03



W3S / V3S2



W03 / V3S5

DOOR FRAMES



adjustable DIN system



fixed metal



adjustable metal



adjustable AQUA DIN



adjustable DIN DUO



fixed metal



adjustable metal



adjustable AQUA DIN DUO



ARCO door, version W03P, adjustable DIN door frame



stile and rail vertical grain, panels and infill horizontal





panels, glazing



for extra charge: **laminated glass VSG 22.1 in black color**

COLOR RANGE – pp. 303-310

ECO TOP		120 white
		233 Salinas oak
LAMISTONE CPL		234 natural oak
		250 Terra oak
		230 gran oak
SILKSTONE		276 Polish oak
		290 Royal oak
		293 Royal anthracite
		295 Royal merbau

INCLUDED IN THE PRICE OF THE DOOR

Stile and rails made of high-quality MDF (vertical 40 mm thick and horizontal 35 mm thick). Vertical elements – vertical grain, horizontal elements – horizontal grain in wood-like decors.

FSC® Mix certificate available only upon Client's request

glass white matt, brown matt or transparent, 4 mm thick
tempered white matt glass, 4 mm thick (version W2D)

REBATED SYSTEM

visible hinge, silver galvanized "60"- "90" – 3 pcs.
type B – for DIN door frame system,
type D – for wooden door frame,
type M – for metal door frame
silver latch-bolt lock: for key, cylinder, bathroom lock, without keyhole

NON-REBATED SYSTEM

concealed hinge, satin nickel "60"- "90" – 3 pcs.
magnetic lock, satin chrome: for key, cylinder, bathroom lock, without keyhole

FOR EXTRA CHARGE

non-standard door sizes	p. 296
tempered transparent glass with a thickness of 4 mm	
laminated glass VSG 22.1 white, black or transparent (applies to 1 pane) – version W02	
laminated glass VSG 22.1 white, black or transparent (applies to 1 pane) – version W03	
door closers, electric strikes	pp. 281, 283
drop seal	
heat recovery ventilation (applies to doors of standard height)	
ventilation undercut	
sliding systems	pp. 168-177

REBATED SYSTEM

change of lock color to black

NON-REBATED SYSTEM

change of hinge color to white or black

change of hinge color to gold

change of magnetic lock color to white, black or gold

non-rebated lock with latch (silver, white, black or gold) - **NEW**

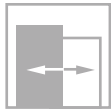
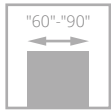

for door leaves with ventilation option



regarding door leaves with ventilation undercut



W02P / V02



W2S / V2S2



W02 / V2S5



W03P / V03



W3S / V3S2



W03 / V3S5

DOOR FRAMES



fixed POL-SKONE system



adjustable DIN system



fixed metal



adjustable metal



adjustable AQUA DIN



adjustable DIN DUO



fixed metal



adjustable metal



adjustable AQUA DIN DUO



UNITO door, version W02, adjustable DIN door frame



stile and rail



panels, glazing

COLOR RANGE – pp. 303-310

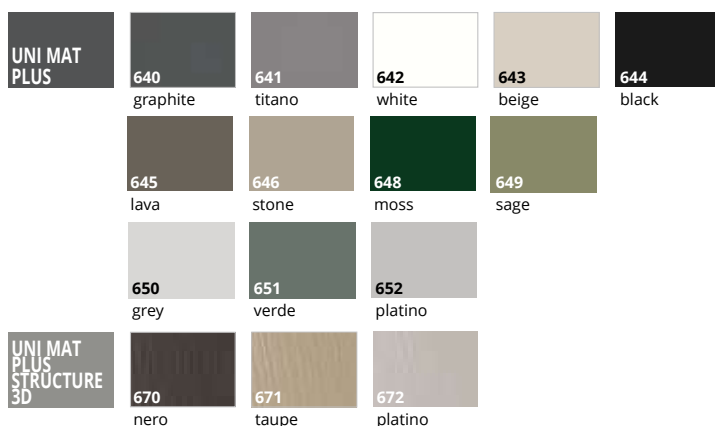

for extra charge: **laminated glass VSG 22.1 in black color**

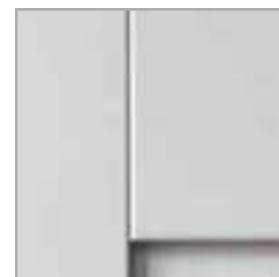

beveling of the edges at the stile and rail joints

INCLUDED IN THE PRICE OF THE DOOR
Stile and rails made of high-quality MDF (vertical and horizontal 40 mm thick), panels made of MDF (16 mm thick). The surface of UNI MAT PLUS and UNI MAT PLUS STRUCTURE 3D is characterized by a silky haptic feel and a special coating resistant to fingerprints.
glass white matt or brown matt, 4 mm thick (versions V2S2, V2S5, V3S2, V3S5)
infill panel 4 mm thick in the color of the door leaf with UNI MAT PLUS surface (version V02)
REBATED SYSTEM
visible hinge, silver galvanized "60"-"90" – 3 pcs.
type B – for DIN system door frame,
type D – for wooden door frame,
type M – for metal door frame
silver latch-bolt lock: for key, cylinder, bathroom lock, without keyhole
NON-REBATED SYSTEM
concealed hinge, satin nickel "60"-"90" – 3 pcs.
magnetic lock, satin chrome: for key, cylinder, bathroom lock, without keyhole

FOR EXTRA CHARGE	
non-standard door sizes	p. 296
laminated glass VSG 22.1 black (applies to 1 pane) – version V2S5	
laminated glass VSG 22.1 black (applies to 1 pane) – version V3S5	
door closers, electric strikes	pp. 281, 283
drop seal	
heat recovery ventilation (applies to doors of standard height)	
ventilation undercut	
sliding systems	pp. 168-177
REBATED SYSTEM	
change of lock color to black	
NON-REBATED SYSTEM	
change of hinge color to white or black	
change of hinge color to gold	
change of magnetic lock color to white, black or gold	
non-rebated lock with latch (silver, white, black or gold) - NEW	

SAMOS

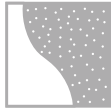
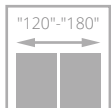
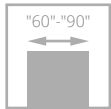

regarding door leaves with ventilation undercut



V01



V156



V158



V151



V155



V153

DOOR FRAMES



fixed POL-SKONE system



adjustable DIN system



fixed metal



adjustable metal



adjustable AQUA DIN



adjustable DIN DUO



fixed metal



adjustable metal



adjustable AQUA DIN DUO



SAMOS door, version V1S5, adjustable DIN door frame





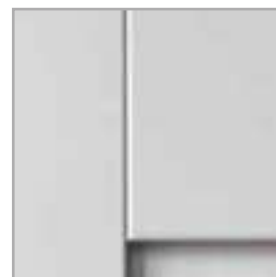



LINEA tempered glass



beveling of the edges at the stile and rail joints

COLOR RANGE – pp. 303-310

LAMISTONE CPL	 233 Salinas Oak	 234 natural oak	 250 Terra oak
	 230 gran oak	 276 Polish oak	 NEW 290 Royal oak

INCLUDED IN THE PRICE OF THE DOOR

Stile and rails made of high-quality MDF (vertical and horizontal, 40 mm thick), muntins in the color of the door leaf or black.

versions V1S6, V1S8, V1S1, V1S5, V1S3 tempered white matt or transparent glass, 4 mm thick, no possibility to use laminated glass VSG 22.1 and VSG 33.1

REBATED SYSTEM

visible hinge, silver galvanized "70"- "90" – 3 pcs.

type B – for DIN door frame system,

type D – for wooden door frame,

type M – for metal door frame

silver latch-bolt lock: for key, cylinder, bathroom lock, without keyhole

NON-REBATED SYSTEM

concealed hinge, satin nickel "60"- "90" – 3 pcs.

magnetic lock, satin chrome: for key, cylinder, bathroom lock, without keyhole

FOR EXTRA CHARGE

non-standard door sizes p. 296

clear Linea glass, 4 mm thick, single-sided ornament

MORU tempered glass, 4 mm thick

door closers, electric strikes pp. 281, 283

drop seal

heat recovery ventilation (applies to doors of standard height)

ventilation undercut

sliding systems pp. 168-177

FORTO

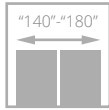
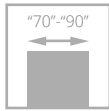

for door leaves with ventilation option



regarding door leaves with ventilation undercut



NEW VERSION

V00



V01



V15



V25

DOOR FRAMES



fixed POL-SKONE system



adjustable DIN system



adjustable DIN SOLID



fixed metal



adjustable metal



adjustable AQUA DIN



fixed DUO



adjustable DIN DUO



adjustable DIN DUO SOLID



adjustable VERTIGO



fixed metal



adjustable metal



adjustable AQUA DIN DUO



FORTO door, version V1S, adjustable SYSTEM DIN door frame





glazing

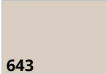

protection of the bottom stile and rail using the HOT FOIL method

COLOR RANGE – pp. 303-310

LAMISTONE CPL						
	231 Halif oak	233 Salinas oak	250 Terra oak	263 premium walnut		
	SILKSTONE					
		230 gran oak	276 Polish oak	290 Royal oak		
UNI MAT PLUS						
	640 graphite	641 titano	642 white	643 beige	644 black	645 lava
						
	646 stone	648 moss	649 sage	650 grey	651 verde	652 platino

INCLUDED IN THE PRICE OF THE DOOR
Stile and rails made of high-quality MDF protected against moisture using the HOT FOIL method (vertical elements with a thickness of 40 mm, horizontal elements with a thickness of 35 mm), MDF panel (16 mm thick), infill panel (4 mm thick). Vertical elements – vertical grain, horizontal elements – horizontal grain in wood-like decors.
VSG 22.1 laminated glass with a thickness of 4 mm in white or black color
REBATED SYSTEM
visible hinge, silver galvanized "70"- "90" – 3 pcs.
type B – for DIN door frame system,
type D – for wooden door frame,
type M – for metal door frame
silver latch-bolt lock: for key, cylinder, bathroom lock, without keyhole
NON-REBATED SYSTEM
concealed hinge, satin nickel "70"- "90" - 3 pcs.
magnetic lock, satin chrome: for key, cylinder, bathroom lock, without keyhole

FOR EXTRA CHARGE	
non-standard door sizes	p. 296
transparent Linea glass with a thickness of 4 mm (applies to 1 pane)	
door closers, electric strikes	pp. 281, 283
drop seal	
heat recovery ventilation (applies to doors of standard height)	
ventilation undercut	
sliding systems	pp. 168-177

MAGRO

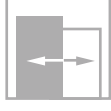
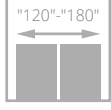
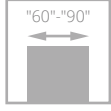

for door leaves with ventilation option



regarding door leaves with ventilation undercut



V03



V3SA

DOOR FRAMES



fixed POL-SKONE system



adjustable DIN system



adjustable DIN SOLID



fixed metal



adjustable metal



adjustable AQUA DIN



fixed DUO



adjustable DIN DUO



adjustable DIN DUO SOLID



adjustable VERTIGO



fixed metal



adjustable metal











adjustable AQUA DIN DUO

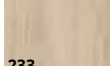
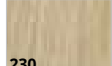

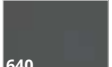
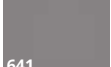
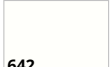
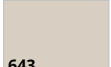
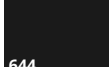
protection of the bottom stile and rail using the HOT FOIL method

MAGRO door, version V03, adjustable DIN SYSTEM door frame

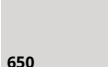
COLOR RANGE – pp. 303-310

LAMISTONE CPL	 250 Terra oak	 233 Salinas oak				
	 230 gran oak	 276 Polish oak	 NEW 290 Royal oak			
UNI MAT PLUS	 640 graphite	 641 titano	 642 white	 643 beige	 644 black	 645 lava
	 646 stone	 648 moss	 649 sage	 650 grey	 651 verde	 652 platino

INCLUDED IN THE PRICE OF THE DOOR

Stile and rails made of high-quality MDF protected against moisture using the HOT FOIL method (vertical elements with a thickness of 40 mm, horizontal elements with a thickness of 35 mm), MDF panel (22 mm thick, 260 mm high), infill panel (4 mm thick). Vertical elements – vertical grain, horizontal elements – horizontal grain in wood-like decors.

white matt glass, brown matt glass, Antisol dark grey glass with a thickness of 4 mm

REBATED SYSTEM

visible hinge, silver galvanized “60”-“90” – 3 pcs.

type B – for DIN door frame system,

type D – for wooden door frame,

type M – for metal door frame

silver latch-bolt lock: for key, cylinder, bathroom lock, without keyhole

NON-REBATED SYSTEM

concealed hinge, satin nickel “60”-“90” – 3 pcs.

magnetic lock, satin chrome: for key, cylinder, bathroom lock, without keyhole

FOR EXTRA CHARGE

non-standard door sizes p. 296

laminated glass VSG 22.1 black color (applies to 1 pane)

door closers, electric strikes, drop seal, heat recovery ventilation not applicable

ventilation undercut

sliding systems pp. 168-177

NEW

LAURA

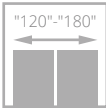
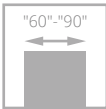

for door leaves with ventilation option



W01 / V01



W02 / V1S1



W03 / V1S2



W04 / V1S3



W05 / V1S4

DOOR FRAMES



fixed POL-SKONE system



adjustable DIN system

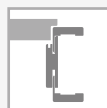

adjustable DIN SOLID



adjustable AQUA DIN



fixed DUO

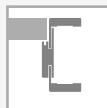

adjustable DIN DUO



adjustable DIN DUO SOLID

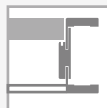

adjustable VERTIGO



adjustable AQUA DIN DUO



combination of stile and rail, panels, and glass

LAURA door, version W04, adjustable door frame DIN DUO SOLID

COLOR RANGE – pp. 303-310

LAMISTONE CPL		213 super white
SILKSTONE		276 Polish oak
		NEW 290 Royal oak

INCLUDED IN THE PRICE OF THE DOOR

Vertical stile and rails made of high-quality MDF with a thickness of 40 mm, panels with a thickness of 25 mm. Upper edge of the door leaf without rebate (in rebated and non-rebated systems).

white matt glass, brown matt glass or transparent glass with a thickness of 4 mm (versions W01-W05)

REBATED SYSTEM

visible hinge, brushed nickel "60"- "80" - 2 pcs., "90" - 3 pcs.
type K - for door frame system DIN,
type C - for wooden door frame
silver latch-bolt lock: for key, cylinder, bathroom lock, without keyhole

NON-REBATED SYSTEM

concealed hinge, satin nickel "60"- "80" - 2 pcs., "90" - 3 pcs.
magnetic lock, satin chrome: for key, cylinder, bathroom lock, without keyhole

FOR EXTRA CHARGE

non-standard door sizes p. 296
tempered transparent glass with a thickness of 4 mm
ventilation undercut
sliding systems pp. 168-177

REBATED SYSTEM

additional visible hinge type K, type C brushed nickel or black
change of lock color to black

NON-REBATED SYSTEM

change of hinge color to white or black
change of hinge color to gold
change of magnetic lock color to white, black or gold
non-rebated lock with latch (silver, white, black or gold)
- NEW

SEMPRE

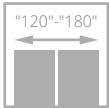
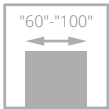

for door leaves with ventilation option



W00 / V01



W01 / V1SD



V1SP



WLZ | WLA/Z

mirror*



W05 VERSE / V6SD

MORE VERSIONS
ON THE NEXT
PAGE



* WLZ - mirror on the hinge side
WLA/Z - mirror on the side opposite to the hinge

DOOR FRAMES



fixed POL-SKONE system



adjustable DIN system



adjustable DIN SOLID



fixed metal



adjustable metal



adjustable AQUA DIN



fixed DUO



adjustable DIN DUO

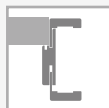

adjustable DIN DUO SOLID

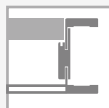

adjustable VERTIGO

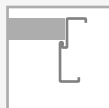

fixed metal



adjustable metal



adjustable AQUA DIN DUO



SEMPRE door, version W01, adjustable DIN SYSTEM door frame



glazing



for extra charge: VSG 22.1 laminated glass in black color

COLOR RANGE - pp. 303-310

LAMISTONE CPL					
	213 super white	231 Halif oak	243 delano oak	263 premium walnut	
	SILKSTONE				
		230 gran oak	276 Polish oak	290 Royal oak	293 Royal anthracite
UNI MAT PLUS					
	642 white	295 Royal merbau			



panel with finished edge glued to the glass - version V1SP

EXTENSIONS FOR SEMPRES DOOR

PRICE OF DOOR LEAF WITH EXTENSION = 2 x PRICE OF DOOR LEAF

WIDTH (rebated system)			WIDTH (non-rebated system)		
type	Ss with rebate	Sds	type	Ss	Sds
"40" + "70"		431	"40" + "70"		412
"50" + "70"	744	531	"50" + "70"	725	512
"60" + "70"		631	"60" + "70"		612
"40" + "80"		431	"40" + "80"		412
"50" + "80"	844	531	"50" + "80"	825	512
"60" + "80"		631	"60" + "80"		612
"40" + "90"		431	"40" + "90"		412
"50" + "90"	944	531	"50" + "90"	925	512
"60" + "90"		631	"60" + "90"		612

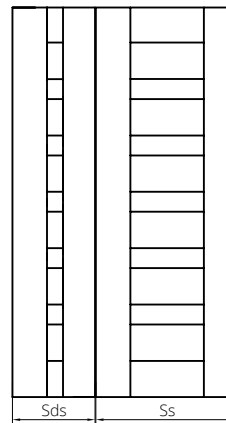

- INCLUDED IN THE PRICE OF THE DOOR**
- Solid construction made of a wooden frame, panels, and infill panels. Vertical elements - vertical grain, horizontal elements - horizontal grain in wood-like decors.
 - white matt glass, brown matt glass, graphite matt glass or transparent glass with a thickness of 4 mm
 - tempered glass white matt with a thickness of 4 mm - version W01, V1SP
 - tempered glass white matt with a thickness of 6 mm - version W05 VERSE
 - panel with a thickness of 12 mm - version W00
 - HDF panel in the color of the door leaf with a thickness of 3.5 mm (double-sided), edges protected - version V1SP
 - single-sided mirror - version WLZ, WLA/Z
 - version W05 VERSE - applies to widths "70" - "100"

- REBATED SYSTEM**
- visible hinge, brushed nickel "60"- "80" - 2 pcs., "90" - 3 pcs.
 - type K - for door frame DIN system,
 - type C - for wooden door frame,
 - type M silver - for metal door frame
 - silver latch-bolt lock: for key, cylinder, bathroom lock, without keyhole

- NON-REBATED SYSTEM**
- concealed hinge, satin nickel "60"- "80" - 2 pcs., "90" - 3 pcs.
 - magnetic lock, satin chrome: for key, cylinder, bathroom lock, without keyhole

- FOR EXTRA CHARGE**
- non-standard door sizes p. 296
 - tempered transparent glass with a thickness of 4 mm
 - laminated glass VSG 22.1 black color (version W02)
 - laminated glass VSG 22.1 black color (version W03)
 - door closers, electric strikes pp. 281, 283
 - drop seal
 - heat recovery ventilation without extra charge
 - ventilation undercut (pp. 286-287)
 - sliding systems pp. 168-177

- REBATED SYSTEM**
- additional visible hinge type M silver
 - additional visible hinge type M black
 - additional visible hinge type K, type C brushed nickel or black
 - change of lock color to black

- NON-REBATED SYSTEM**
- additional concealed hinge satin nickel
 - change of hinge color to white or black
 - change of hinge color to gold
 - change of magnetic lock color to white, black or gold
 - non-rebated lock with latch (silver, white, black or gold) - NEW

SEMPRE

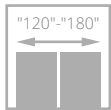
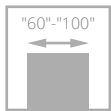

for door leaves with ventilation option



W02P / V02



W02 / V2S5



W02S2 / V2S2



W02S3 / V2S3



W02S4 / V2S4



W03P / V03



W03 / V3S5



W03S2 / V3S2



W03S3 / V3S3



W03S4 / V3S4

**MORE VERSIONS
ON THE PREVIOUS
PAGE**

DOOR FRAMES



fixed POL-SKONE system



adjustable DIN system



adjustable DIN SOLID



fixed metal



adjustable metal



adjustable AQUA DIN



fixed DUO



adjustable DIN DUO



adjustable DIN DUO SOLID



adjustable VERTIGO



fixed metal



adjustable metal



adjustable AQUA DIN DUO

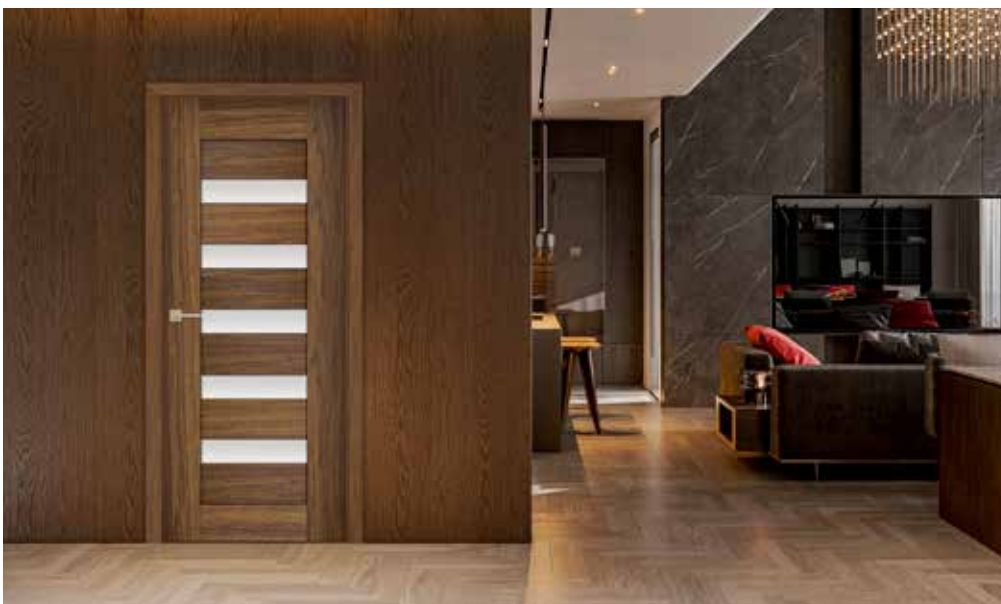

SEMPRE door, version W02, adjustable door frame DIN SYSTEM



glazing



for extra charge: VSG 22.1 laminated glass in black color

COLOR RANGE - pp. 303-310

LAMISTONE CPL					
	213 super white	231 Halif oak	243 delano oak	263 premium walnut	
	SILKSTONE				
		230 gran oak	276 Polish oak	290 Royal oak	293 Royal anthracite
		295 Royal merbau			
UNI MAT PLUS					
	642 white				



panel with finished edge glued to the glass - version V1SP

EXTENSIONS FOR SEMPRE DOOR

PRICE OF DOOR LEAF WITH EXTENSION = 2 x PRICE OF DOOR LEAF

WIDTH (rebated system)			WIDTH (non-rebated system)		
type	Ss with rebate	Sds	type	Ss	Sds
"40" + "70"		431	"40" + "70"		412
"50" + "70"	744	531	"50" + "70"	725	512
"60" + "70"		631	"60" + "70"		612
"40" + "80"		431	"40" + "80"		412
"50" + "80"	844	531	"50" + "80"	825	512
"60" + "80"		631	"60" + "80"		612
"40" + "90"		431	"40" + "90"		412
"50" + "90"	944	531	"50" + "90"	925	512
"60" + "90"		631	"60" + "90"		612

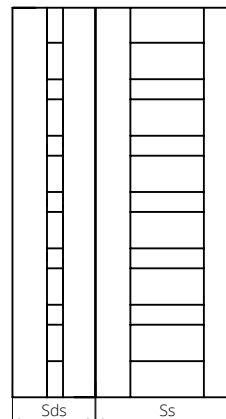

- INCLUDED IN THE PRICE OF THE DOOR**
- Solid construction made of a wooden frame, panels, and infill panels.
 - Vertical elements - vertical grain, horizontal elements - horizontal grain in wood-like decors.
 - white matt glass, brown matt glass, graphite matt glass or transparent glass with a thickness of 4 mm
 - tempered glass white matt with a thickness of 4 mm - version W01, V1SP
 - tempered glass white matt with a thickness of 6 mm - version W05 VERSE
 - panel with a thickness of 12 mm - version W00
 - HDF panel in the color of the door leaf with a thickness of 3.5 mm (double-sided), edges protected - version V1SP
 - single-sided mirror - version WLZ, WLA/Z
 - version W05 VERSE - applies to widths "70" - "100"

- REBATED SYSTEM**
- visible hinge, brushed nickel "60"- "80" - 2 pcs., "90" - 3 pcs.
 - type K - for door frame DIN system,
 - type C - for wooden door frame,
 - type M silver - for metal door frame
 - silver latch-bolt lock: for key, cylinder, bathroom lock, without keyhole

- NON-REBATED SYSTEM**
- concealed hinge, satin nickel "60"- "80" - 2 pcs., "90" - 3 pcs.
 - magnetic lock, satin chrome: for key, cylinder, bathroom lock, without keyhole

- FOR EXTRA CHARGE**
- non-standard door sizes p. 296
 - tempered transparent glass with a thickness of 4 mm
 - laminated glass VSG 22.1 black color (version W02)
 - laminated glass VSG 22.1 black color (version W03)
 - door closers, electric strikes pp. 281, 283
 - drop seal
 - heat recovery ventilation without extra charge
 - ventilation undercut (pp. 286-287)
 - sliding systems pp. 168-177

- REBATED SYSTEM**
- additional visible hinge type M silver
 - additional visible hinge type M black
 - additional visible hinge type K, type C brushed nickel or black
 - change of lock color to black

- NON-REBATED SYSTEM**
- additional concealed hinge satin nickel
 - change of hinge color to white or black
 - change of hinge color to gold
 - change of magnetic lock color to white, black or gold
 - non-rebated lock with latch (silver, white, black or gold) - NEW

FORTIMO

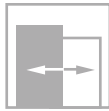
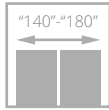
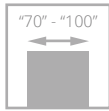

W01 / V01



W01S1 / V1S



for door leaves with ventilation option



W03S1 / V2S



INTERIOR DOORS STILE AND RAIL TYPE LAMINATED

DOOR FRAMES



fixed POL-SKONE system



adjustable DIN system



adjustable DIN SOLID



fixed metal



adjustable metal



adjustable AQUA DIN



fixed DUO



adjustable DIN DUO



adjustable DIN DUO SOLID



adjustable VERTIGO



fixed metal



adjustable metal



adjustable AQUA DIN DUO



glazing

FORTIMO door, version W03S1, adjustable door frame DIN

COLOR RANGE – pp. 303-310

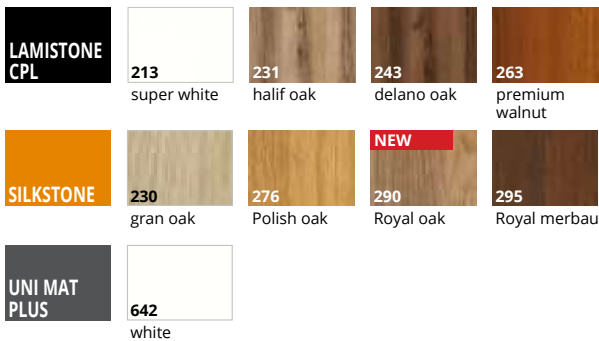

INCLUDED IN THE PRICE OF THE DOOR

Solid construction made of a wooden stile and rail. Vertical elements – vertical grain, horizontal elements – horizontal grain in wood-like decors.
tempered glass white matt with a thickness of 4 mm
width "60" (applies to versions W01, W01S1)

REBATED SYSTEM

visible hinge, silver galvanized "70"- "90" – 3 pcs.
type K - for door frame DIN system,
type C - for wooden door frame,
type M - for metal door frame
silver latch-bolt lock: for key, cylinder, bathroom lock, without keyhole

NON-REBATED SYSTEM

concealed hinge, satin nickel "70"- "90" - 3 pcs.
magnetic lock, satin chrome: for key, cylinder, bathroom lock, without keyhole

FOR EXTRA CHARGE

non-standard door sizes p. 296
tempered glass brown matt, graphite matt or transparent with a thickness of 4 mm
laminated glass VSG 22.1 white matt or transparent
laminated glass VSG 22.1 black
door closers, electric strikes pp. 281, 283
drop seal
heat recovery ventilation (applies to doors of standard height)
ventilation undercut
sliding systems pp. 168-177

REBATED SYSTEM

additional visible hinge type M silver
additional visible hinge type M black
additional visible hinge type K, type C brushed nickel or black
change of lock color to black

NON-REBATED SYSTEM

change of hinge color to white or black
change of hinge color to gold
change of magnetic lock color to white, black or gold
non-rebated lock with latch (silver, white, black or gold) - **NEW**

SLIM

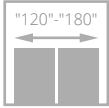
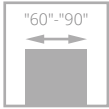

for door leaves with ventilation option



regarding door leaves with ventilation undercut



V03



V3S1



V3SA



V3S2



V3S3



V3S4



V3S5

DOOR FRAMES



fixed POL-SKONE system



adjustable DIN system



adjustable DIN SOLID



fixed metal



adjustable metal



adjustable AQUA DIN



fixed DUO



adjustable DIN DUO



adjustable DIN DUO SOLID



adjustable VERTIGO



fixed metal



adjustable metal



adjustable AQUA DIN DUO



SLIM door, version V3S5, adjustable door frame DIN

COLOR RANGE – pp. 303-310

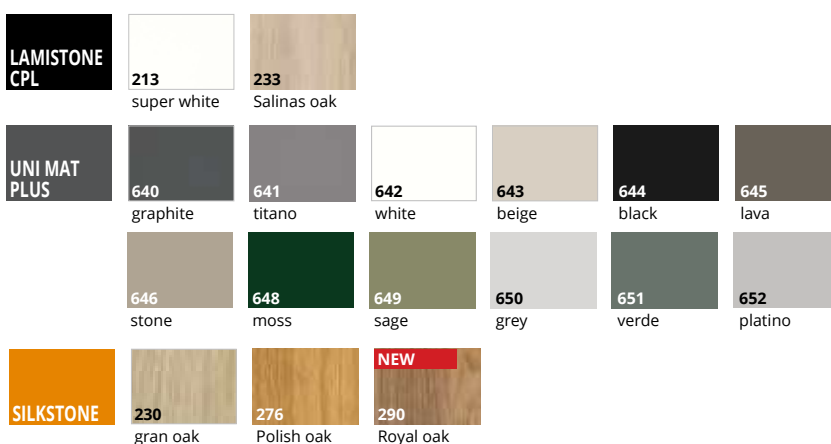

INCLUDED IN THE PRICE OF THE DOOR
Solid construction made of a stile and rail from laminated wood. Vertical stile and rail with a thickness of 40 mm, horizontal stile and rail with a thickness of 35 mm, MDF panels with a thickness of 22 mm and a height of 260 mm. Vertical elements – vertical grain, horizontal elements – horizontal grain in wood-like decors.
glass white matt or brown matt with a thickness of 4 mm - versions V3S1, V3S2, V3S3, V3S4, V3S5, V3SA
panel in the color of the door leaf with a thickness of 4 mm - versions V03, V3S1, V3S2, V3S3, V3S4, V3SA
REBATED SYSTEM visible hinge, brushed nickel "60"- "80" - 2 pcs., "90" - 3 pcs. type K - for door frame DIN system, type C - for wooden door frame, type M silver - for metal door frame silver latch-bolt lock: for key, cylinder, bathroom lock, without keyhole
NON-REBATED SYSTEM concealed hinge, satin nickel "60"- "80" - 2 pcs., "90" - 3 pcs. magnetic lock, satin chrome: for key, cylinder, bathroom lock, without keyhole
color 644 black
rebated system - silver hinges and black lock
non-rebated system - black hinges and lock
color 642 white, super white 213
rebated system - silver hinges and lock
non-rebated system - white hinges and lock

FOR EXTRA CHARGE	
non-standard door sizes	p. 296
laminated glass VSG 22.1 black - applies to 1 pane	
door closers, electric strikes	not possible
drop seal	
heat recovery ventilation (applies to doors of standard height)	
ventilation undercut	
sliding systems	pp. 168-177
REBATED SYSTEM additional visible hinge type M silver additional visible hinge type M black additional visible hinge type K, type C brushed nickel or black change of lock color to black	
NON-REBATED SYSTEM change of hinge color to white or black change of hinge color to gold change of magnetic lock color to white, black or gold non-rebated lock with latch (silver, white, black or gold) - NEW	

MONA

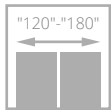
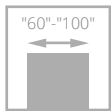

for door leaves with ventilation option



W01S1 / V1S with black pane



W02S2 / V2S with black pane (does not apply to "60")



DOOR FRAMES



fixed POL-SKONE system



adjustable DIN system



adjustable DIN SOLID



fixed metal



adjustable metal



adjustable AQUA DIN



fixed DUO



adjustable DIN DUO



adjustable DIN DUO SOLID



adjustable VERTIGO













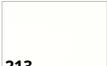

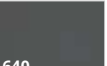
adjustable AQUA DIN DUO

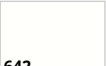
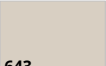
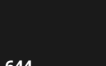

black pane

MONA door, version W02S2, adjustable door frame DIN DUO SYSTEM

COLOR RANGE – pp. 303-310

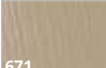
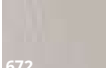
LAMISTONE CPL						
	213 super white	231 Halif oak	243 delano oak			
UNI MAT PLUS						
	640 graphite	641 titano	642 white	643 beige	644 black	645 lava
						
	646 stone	648 moss	649 sage	650 grey	651 verde	652 platino
	UNI MAT PLUS STRUCTURE 3D					
670 nero		671 taupe	672 platino			

INCLUDED IN THE PRICE OF THE DOOR
Solid construction made of a wooden stile and rail. Vertical elements – vertical grain, horizontal elements – horizontal grain in wood-like decors. laminated glass VSG 22.1 black with a thickness of 4.2 mm
REBATED SYSTEM visible hinge, brushed nickel "60"-80" - 2 pcs., "90" - 3 pcs. type K - for door frame DIN system, type C - for wooden door frame, type M silver - for metal door frame silver latch-bolt lock: for key, cylinder, bathroom lock, without keyhole
NON-REBATED SYSTEM concealed hinge, satin nickel "60"-80" - 2 pcs., "90" - 3 pcs. magnetic lock, satin chrome: for key, cylinder, bathroom lock, without keyhole

FOR EXTRA CHARGE	
non-standard door sizes	p. 296
tempered glass brown matt, graphite matt or transparent with a thickness of 4 mm	
laminated glass VSG 22.1 white matt or transparent	
door closers, electric strikes	pp. 281, 283
drop seal	
heat recovery ventilation (applies to doors of standard height)	
ventilation undercut	
sliding systems	pp. 168-177
REBATED SYSTEM	
additional visible hinge type M silver	
additional visible hinge type M black	
additional visible hinge type K, type C brushed nickel or black	
change of lock color to black	
NON-REBATED SYSTEM	
change of hinge color to white or black	
change of hinge color to gold	
change of magnetic lock color to white, black or gold	
non-rebated lock with latch (silver, white, black or gold) - NEW	

PASSO

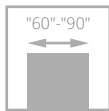

for door leaves with ventilation option



W01 / V01



W02 / V1S1



W03 / V1S2



W04 / V1S3



W05 / V1S4

DOOR FRAMES



fixed POL-SKONE system



adjustable DIN system



adjustable DIN SOLID



adjustable AQUA DIN



fixed DUO



adjustable DIN DUO



adjustable DIN DUO SOLID



adjustable VERTIGO



adjustable AQUA DIN DUO



combination of stile and rail, panels, and glass

PASSO door, version W03 (door on the left), W02 (door on the right), adjustable door frame DIN DUO SOLID

COLOR RANGE – pp. 303-310

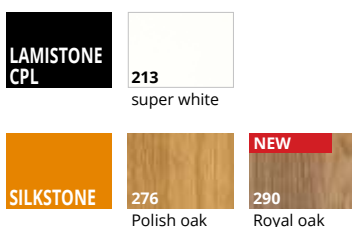

INCLUDED IN THE PRICE OF THE DOOR

Solid construction made of a stile and rail from laminated wood. The upper edge of the door leaf without a rebate (in the rebated and non-rebated system).

white matt glass, brown matt glass or transparent glass with a thickness of 4 mm (versions W01-W05)

REBATED SYSTEM

visible hinge, brushed nickel "60"- "80" - 2 pcs., "90" - 3 pcs.
type K - for door frame system DIN, type C - for wooden door frame
silver latch-bolt lock: for key, cylinder, bathroom lock, without keyhole

NON-REBATED SYSTEM

concealed hinge, satin nickel "60"- "80" - 2 pcs., "90" - 3 pcs.
magnetic lock, satin chrome: for key, cylinder, bathroom lock, without keyhole

FOR EXTRA CHARGE

non-standard door sizes p. 296

tempered transparent glass with a thickness of 4 mm

ventilation undercut

sliding systems pp. 168-177

REBATED SYSTEM

additional visible hinge type K, type C brushed nickel or black

change of lock color to black

NON-REBATED SYSTEM

change of hinge color to white or black

change of hinge color to gold

change of magnetic lock color to white, black or gold

non-rebated lock with latch (silver, white, black or gold) - **NEW**

HAPTIC

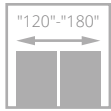
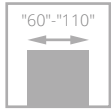

00 / V00



02 / V2S



04 / V4SD



05 / V5SD



03SD / V3SD

DOOR FRAMES



adjustable
DIN system



adjustable
DIN SOLID



fixed metal



adjustable metal



adjustable
AQUA DIN



adjustable
REVES system



fixed DUO



adjustable
DIN DUO



adjustable
DIN DUO SOLID



adjustable
VERTIGO



fixed metal



adjustable metal



adjustable
AQUA DIN DUO



HAPTIC door, version 00, adjustable DIN door frame

COLOR RANGE – pp. 303-310

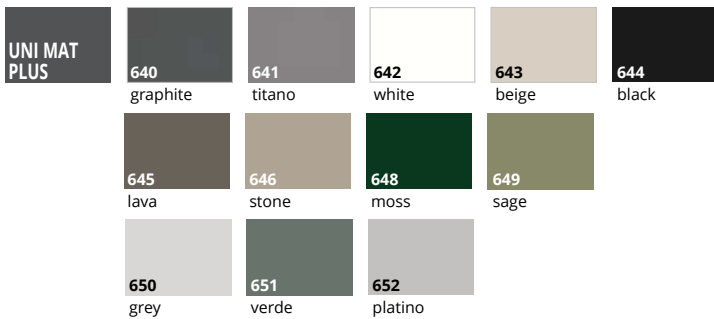

ABS EDGES

without extra charge



INCLUDED IN THE PRICE OF THE DOOR	
Solid construction made of a wooden frame, filled with a layer of "honeycomb" structure. UNI MAT PLUS Surface is characterized by a special coating resistant to fingerprints.	
glass white matt, brown matt or transparent, 4 mm thick	
tempered glass white matt or brown matt with a thickness of 4 mm (version 03SD)	
REBATED SYSTEM	
visible hinge silver galvanized "60"-80" - 2 pcs., "90" - 3 pcs.	
type K, type T - for DIN system door frame,	
type C - for wooden door frame, type M - for metal door frame	
silver latch-bolt lock: for key, cylinder, bathroom lock, without keyhole	
NON-REBATED SYSTEM	
concealed hinge, satin nickel "60"-80" - 2 pcs., "90" - 3 pcs.	
magnetic lock, satin chrome: for key, cylinder, bathroom lock, without keyhole	
FOR EXTRA CHARGE	
non-standard door sizes	p. 296
tempered and laminated glass	p. 302
stile and rail (enabling self-shortening up to 50 mm)	
stile and rail (enabling self-shortening up to 90 mm)	
perforated chipboard filling	
solid chipboard filling (third hinge recommended)	
door closers, electric strikes	pp. 281, 283
reinforcement for door closer	
drop seal	

heat recovery ventilation	without extra charge
ventilation undercut (pp. 286-287)	
ABS edge in black, white, titano, Polish oak or anthracite color (not applicable to the REVES system)	without extra charge
sliding systems	pp. 168-177
REBATED SYSTEM	
additional visible hinge type M silver galvanized	
additional visible hinge type M black	
additional visible hinge type K, type C silver galvanized or black	
additional visible hinge type T silver	
change of hinge color type T to black or gold	
change of lock color to black	
in the case of a door leaf with a door closer and a DIN or metal door frame, type T hinges should be used in the following quantities: "60"-80" - 3 pcs.; "90"-110" - 4 pcs.; extra charge for additional hinge type T	
NON-REBATED SYSTEM	
additional concealed hinge satin nickel	
change of hinge color to white or black	
change of hinge color to gold	
change of magnetic lock color to white, black or gold	
non-rebated lock with latch (silver, white, black or gold) - NEW	
REVES SYSTEM (reverse rebate) - version 00	
additional concealed TE hinge, silver	
change of TE hinge color to white or black	
change of TE hinge color to gold	

IMPULS

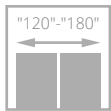
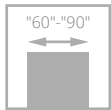

W01 / V00



W02 / V2S



W03 / V3SD



W05 / V1SD



W06 / V4SD



W07 / V5SD



W13 / V1SA



W14 / V1SA

DOOR FRAMES



fixed POL-SKONE system



adjustable DIN system



adjustable DIN SOLID



fixed metal



adjustable metal



adjustable AQUA DIN



adjustable REVES system



fixed DUO



adjustable DIN DUO



adjustable DIN DUO SOLID



adjustable VERTIGO



fixed metal



adjustable metal



adjustable AQUA DIN DUO



frame profile



door frame

IMPULS door, version W14, adjustable SYSTEM DIN door frame

COLOR RANGE – pp. 303-310



* while stocks last

INCLUDED IN THE PRICE OF THE DOOR	
Solid construction made of a wooden frame, filled with a layer of "honeycomb" structure.	
glass white matt, brown matt or transparent with a thickness of 4 mm (version W03, W05)	
tempered glass white matt or brown matt with a thickness of 4 mm (version 03SD)	
REBATED SYSTEM	
visible hinge silver galvanized "60"-80" - 2 pcs., "90" - 3 pcs.	
type K, type T - for DIN system door frame, type C - for wooden door frame, type M - for metal door frame	
silver latch-bolt lock: for key, cylinder, bathroom lock, without keyhole	
NON-REBATED SYSTEM	
concealed hinge, satin nickel "60"-80" - 2 pcs., "90" - 3 pcs.	
magnetic lock, satin chrome: for key, cylinder, bathroom lock, without keyhole	
FOR EXTRA CHARGE	
non-standard door sizes	p. 296
tempered and laminated glass	p. 302
stile and rail (enabling self-shortening up to 50 mm)	
stile and rail (enabling self-shortening up to 90 mm)	
perforated chipboard filling	
solid chipboard filling (third hinge recommended)	
door closers, electric strikes	pp. 281, 283
reinforcement for door closer	
drop seal	
heat recovery ventilation	without extra charge

ventilation undercut (pp. 286-287)	
ABS edge in black, white, titano, Polish oak or anthracite color (not applicable to the REVES system)	without extra charge
sliding systems	pp. 168-177
REBATED SYSTEM	
additional visible hinge type M silver galvanized	
additional visible hinge type M black	
additional visible hinge type K, type C silver galvanized or black	
additional visible hinge type T silver	
change of hinge color type T to black or gold	
change of lock color to black	
in the case of a door leaf with a door closer and a DIN or metal door frame, type T hinges should be used in the following quantities: "60"-80" - 3 pcs.; "90"-110" - 4 pcs.; extra charge for additional hinge type T	
NON-REBATED SYSTEM	
additional concealed hinge satin nickel	
change of hinge color to white or black	
change of hinge color to gold	
change of magnetic lock color to white, black or gold	
non-rebated lock with latch (silver, white, black or gold) - NEW	
REVES SYSTEM (reverse rebate) - version 00	
additional concealed TE hinge, silver	
change of TE hinge color to white or black	
change of TE hinge color to gold	

DECO

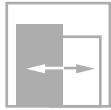
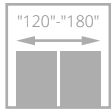
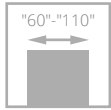

00 / V00



02 / V2S



03SD / V3SD



04 / V4SD



05 / V5SD

INTERIOR DOORS PANEL TYPE LAMINATED

DOOR FRAMES



fixed POL-SKONE system



adjustable DIN system



adjustable DIN SOLID



fixed metal



adjustable metal



metal DIAGONAL



adjustable AQUA DIN



adjustable REVES system



fixed DUO



adjustable DIN DUO



adjustable DIN DUO SOLID



fixed metal



adjustable metal



adjustable AQUA DIN DUO



DECO door, version 00, adjustable DIN SYSTEM door frame

frame

glazing

COLOR RANGE – pp. 303-310

LAMINATED CPL 0,2 mm	820	222	821	863	225	227	844	280	833	834
	white	grey	anthracite	premium walnut	Terra oak	delano oak	black	Halif oak	Salinas oak	natural oak
LAMINATED CPL 0,5 mm*	945	922	926	963	946	961	933	934	825	
	white structure	grey structure	anthracite structure	premium walnut	black structure	Halif oak	Salinas oak	natural oak	Terra oak	
LAMINATED HPL*										

For door leaves with structured laminate, the surface of the door frame is with smooth laminate.

* available for extra charge after consultation with the Sales Department

INCLUDED IN THE PRICE OF THE DOOR	
Solid construction made of a wooden frame, filled with a layer of "honeycomb" structure. The surface is covered with CPL laminate with a thickness of 0.2 mm and 0.5 mm or HPL with a thickness of 0.8 mm - resistant to abrasion and chemicals.	
glass white matt or transparent with a thickness of 4 mm	
tempered glass white matt with a thickness of 4 mm (version 03SD)	
REBATED SYSTEM	
visible hinge silver galvanized "60"- "80" - 2 pcs., "90" - 3 pcs.	
type K, type T - for DIN system door frame, type C - for wooden door frame, type M - for metal door frame	
silver latch-bolt lock: for key, cylinder, bathroom lock, without keyhole	
NON-REBATED SYSTEM	
concealed hinge, satin nickel "60"- "80" - 2 pcs., "90" - 3 pcs.	
magnetic lock, satin chrome: for key, cylinder, bathroom lock, without keyhole	
FOR EXTRA CHARGE	
non-standard door sizes	p. 296
tempered and laminated glass	p. 302
stile and rail (enabling self-shortening up to 50 mm)	
stile and rail (enabling self-shortening up to 90 mm)	
perforated chipboard filling	
solid chipboard filling (third hinge recommended)	
extra charge for CPL laminate 0.5 mm ("90+" - "110")*	
door closers, electric strikes	pp. 281, 283
reinforcement for door closer	
drop seal	

* extra charge for standard door height

heat recovery ventilation	without extra charge
ventilation undercut (pp. 286-287)	
edge in black, grey or graphite color	without extra charge
ABS edge in black, white, titano, Polish oak or anthracite color (not applicable to the REVES system)	without extra charge
sliding systems	pp. 168-177
REBATED SYSTEM	
additional visible hinge type M silver galvanized	
additional visible hinge type M black	
additional visible hinge type K, type C silver galvanized or black	
additional visible hinge type T silver	
change of hinge color type T to black or gold	
change of lock color to black	
in the case of a door leaf with a door closer and a DIN or metal door frame, type T hinges should be used in the following quantities: "60"- "80" - 3 pcs.; "90"- "110" - 4 pcs.; extra charge for additional hinge type T	
NON-REBATED SYSTEM	
additional concealed hinge satin nickel	
change of hinge color to white or black	
change of hinge color to gold	
change of magnetic lock color to white, black or gold	
non-rebated lock with latch (silver, white, black or gold) - NEW	
REVES SYSTEM (reverse rebate) - version 00	
additional concealed TE hinge, silver	
change of TE hinge color to white or black	
change of TE hinge color to gold	

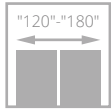
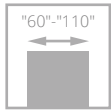

00 / V00



02 / V2S



03SD / V3SD



04 / V4SD



05 / V5SD

It is possible to order doors for widths "100", "110" and higher after consultation with the Sales Department

DOOR FRAMES



adjustable
DIN system



adjustable
DIN SOLID



fixed metal



adjustable metal



metal DIAGONAL



adjustable
AQUA DIN



adjustable
DIN DUO



adjustable
DIN DUO SOLID

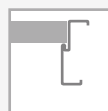

fixed metal



adjustable metal



adjustable
AQUA DIN DUO



frame cross-section

DECO EGGER door, version 00, adjustable DIN SYSTEM door frame

COLOR RANGE – pp. 303-310

LAMINATED HPL EGGER 0.8 mm GROUP A	H54 cashmere ST9	H55 grey ST9	H56 alpine white ST9	LAMINATED HPL EGGER 0.8 mm GROUP B	H50 light vincenza oak ST12	H51 vincenza oak ST12	H52 natural kendal oak ST12	H53 oiled kendal oak ST12	H57 natural hickory ST10
	574 cashmere ST9	575 grey ST9	576 alpine white ST9		LAMINATED CPL EGGER 0.2 mm GROUP A	570 light vincenza oak ST12	571 vincenza oak ST12	572 natural kendal oak ST12	573 oiled kendal oak ST12

ADJUSTABLE DOOR FRAME WITH 80 MM TRIMS, with trims joined at a 45° angle

DIN		DIN AQUA		DIN SOLID		DIN DUO		DIN DUO AQUA		DIN DUO SOLID	
symbol	EGGER 0.2 LAMINATE	symbol	EGGER 0.2 LAMINATE	symbol	EGGER 0.2 LAMINATE	symbol	EGGER 0.2 LAMINATE	symbol	EGGER 0.2 LAMINATE	symbol	EGGER 0.2 LAMINATE
ZP1A		ZP1A		ZP1A		ZD1		ZD1		ZD1	
ZP1B		ZP1B		ZP1B		ZD2		ZD2		ZD2	
ZP2		ZP2		ZP2		ZD3		ZD3		ZD3	
ZP3		ZP3		ZP3		ZD4		ZD4		ZD4	
ZP4		ZP4		ZP4		ZD5		ZD5		ZD5	
ZP5		ZP5		ZP5		ZD6		ZD6		ZD6	
ZP6		ZP6		ZP6		ZD7		ZD7		ZD7	
ZP7		ZP7		ZP7		ZD8		ZD8		ZD8	
ZP8		ZP8		ZP8		ZD9		ZD9		ZD9	
ZP9		ZP9		ZP9		ZD10		ZD10		ZD10	
ZP10		ZP10		ZP10		ZD11		ZD11		ZD11	
ZP11		ZP11		ZP11		ZD12		ZD12		ZD12	
						ZD13		ZD13		ZD13	

INCLUDED IN THE PRICE OF THE DOOR

Solid construction made of a wooden frame, filled with a layer of "honeycomb" structure. The surface is covered with CPL 0.2 laminate or HPL EGGER with a thickness of 0.8 mm, featuring high resistance to mechanical damage and scratches. It is characterized by resistance to moisture, temperature changes, and ease of maintenance.

glass white matt or transparent with a thickness of 4 mm

tempered glass white matt with a thickness of 4 mm (version 03SD)

REBATED SYSTEM

visible hinge silver galvanized "60"- "80" - 2 pcs., "90" - 3 pcs.
type K, type T - for DIN system door frame, type C - for wooden door frame, type M - for metal door frame
silver latch-bolt lock: for key, cylinder, bathroom lock, without keyhole

NON-REBATED SYSTEM

concealed hinge, satin nickel "60"- "80" - 2 pcs., "90" - 3 pcs.
magnetic lock, satin chrome: for key, cylinder, bathroom lock, without keyhole

FOR EXTRA CHARGE

non-standard door sizes	p. 296
tempered and laminated glass	p. 302
stile and rail (enabling self-shortening up to 50 mm)	
stile and rail (enabling self-shortening up to 90 mm)	
perforated chipboard filling	
solid chipboard filling (third hinge recommended)	
door closers, electric strikes	pp. 281, 283
reinforcement for door closer	

drop seal

heat recovery ventilation

without extra charge

ventilation undercut (pp. 286-287)

edge in black, grey or graphite color

without extra charge

ABS edge in black, white, titano, Polish oak or anthracite color (not applicable to the REVES system)

without extra charge

sliding systems

pp. 168-177

REBATED SYSTEM

additional visible hinge type M silver galvanized
additional visible hinge type M black
additional visible hinge type K, type C silver galvanized or black
additional visible hinge type T silver
change of hinge color type T to black or gold

change of lock color to black

in the case of a door leaf with a door closer and a DIN or metal door frame, T-type hinges should be used in the following quantities: "60"- "80" - 3 pcs., "90"- "110" - 4 pcs., extra charge for an additional T-type hinge.

NON-REBATED SYSTEM

additional concealed hinge satin nickel
change of hinge color to white or black
change of hinge color to gold
change of magnetic lock color to white, black or gold
non-rebated lock with latch (silver, white, black or gold) - **NEW**

INVERNO

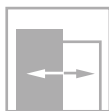
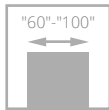

00 / V01



OSD / V1SD



V1SP



01 / V02



01SD / V2SD

DOOR FRAMES



fixed POL-SKONE system



adjustable DIN system



adjustable DIN SOLID



fixed metal



adjustable metal



adjustable AQUA DIN



adjustable REVES system



fixed DUO



adjustable DIN DUO



adjustable DIN DUO SOLID



adjustable VERTIGO



fixed metal



adjustable metal



adjustable AQUA DIN DUO



door INVERNO, version 01, adjustable DIN SYSTEM door frame



moulding profile



panel with finished edge glued to the glass - version V1SP

COLOR RANGE - pp. 303-310

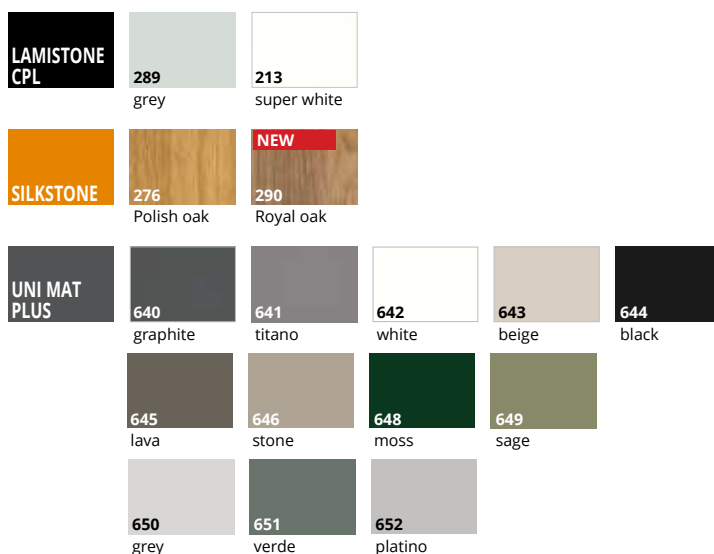

INCLUDED IN THE PRICE OF THE DOOR

The structure of the door leaf consists of a wooden stile and rail, filled with a perforated board. Decorative profile frame in the color of the door leaf. tempered glass white matt with a thickness of 4 mm (versions OSD, 01SD, V1SP)

it is not possible to use transparent glass

REBATED SYSTEM

visible hinge silver galvanized "60"- "80" - 2 pcs., "90" - 3 pcs.
type K - for door frame DIN system, type C - for wooden door frame, type M - for metal door frame
silver latch-bolt lock: for key, cylinder, bathroom lock, without keyhole

NON-REBATED SYSTEM

concealed hinge, satin nickel "60"- "80" - 2 pcs., "90" - 3 pcs.
magnetic lock, satin chrome: for key, cylinder, bathroom lock, without keyhole

FOR EXTRA CHARGE

non-standard door sizes	p. 296
tempered Antisol grey glass (version V1SP)	
tempered Antisol dark grey, brown glass (version V1SP)	
door closers, electric strikes	pp. 281, 283
drop seal	
heat recovery ventilation (applies to doors of standard height)	
ventilation undercut	
sliding systems	pp. 168-177

REBATED SYSTEM

additional visible hinge type M silver galvanized
additional visible hinge type M black
additional visible hinge type K, type C galvanized silver or black
change of lock color to black
in the case of a door leaf with a door closer and a DIN or metal door frame, type T hinges should be used in the following quantities: "60"- "80" - 3 pcs.; "90"- "110" - 4 pcs.; extra charge for additional hinge type T

NON-REBATED SYSTEM

additional concealed hinge satin nickel
change of hinge color to white or black
change of hinge color to gold
change of magnetic lock color to white, black or gold
non-rebated lock with latch (silver, white, black or gold) - **NEW**
REVES SYSTEM (reverse rebate - applies to versions V01, V02) above the ZW4 range, the door opening angle is 88°
additional concealed TE hinge, silver
change of TE hinge color to white or black
change of TE hinge color to gold

CREATO

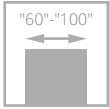

A01 / V1SA



A02 / V2SA

TEMPERED GLASS WHITE MATT OR GRAPHITE WITH A THICKNESS OF 6 MM



A01 / V1SA



A02 / V2SA

TRANSPARENT, LAMINATED GLASS WHITE MATT OR BLACK



A01 / V1SA

LINEA BLACK GLASS

DOOR FRAMES



fixed system
POL-SKONE



adjustable
DIN SOLID



adjustable
DIN system



fixed metal



adjustable metal



adjustable
AQUA DIN



adjustable
REVES system



fixed DUO



adjustable
DIN DUO



adjustable
DIN DUO SOLID



adjustable
VERTIGO



fixed metal



adjustable metal



adjustable
AQUA DIN DUO



CREATO door, version A01, adjustable DIN SYSTEM door frame



concealed white hinge - option



LINEA black glass VSG/ESG 44.4 with double-sided ornament (version A01)



transparent glass, white matt, black or graphite (version A01, A02)

COLOR RANGE - pp. 303-310

UNI MAT PLUS	640 graphite	641 titano	642 white	643 beige	644 black
	645 lava	646 stone	648 moss	649 sage	
	650 grey	651 verde	652 platino		

INCLUDED IN THE PRICE OF THE DOOR

The structure of the door leaf consists of a wooden stile and rail, filled with a perforated board. The UNI MAT PLUS surface is characterized by a special coating resistant to fingerprints.

laminated safety glass VSG 44.2 in white matt, black or transparent color, thickness 8.5 mm (glazing width version A01-58 mm, A02-208 mm)*

tempered Linea black glass VSG/ESG 44.4 with double-sided ornament
tempered glass white matt or graphite, thickness 6 mm

versions with black laminated glass: black lock, hinges type T or concealed black; versions with transparent or white matt laminated glass: silver lock and hinges

REBATED SYSTEM

visible hinge silver galvanized "60"- "80" - 2 pcs., "90" - 3 pcs.
type T - for DIN system and metal door frame,
type C or D silver - for wooden door frame
silver latch-bolt lock: for key, cylinder, bathroom lock, without keyhole

NON-REBATED SYSTEM

concealed satin nickel hinge "60"- "70" - 2 pcs., "80"- "90" - 3 pcs.
magnetic lock, satin chrome: for key, cylinder, bathroom lock, without keyhole

FOR EXTRA CHARGE

non-standard door sizes	p. 296
solid chipboard filling (third hinge recommended)	
door closers, electric strikes	pp. 281, 283
drop seal	not possible
heat recovery ventilation	without extra charge
ventilation undercut in version A01 in widths "60"- "100" (pp. 286-287)	
ventilation undercut in version A02 in widths "70"- "100" (pp. 286-287)	
sliding systems (not applicable to version A01)	pp. 168-177
edge of the door leaf in black color (not applicable to REVES system)	without extra charge

REBATED SYSTEM

additional visible hinge type T silver	
additional visible hinge type T black	
change of hinge color type T to black or gold	
additional visible hinge silver type D	
additional visible hinge type C silver or black	
change of lock color to black	

NON-REBATED SYSTEM

additional concealed hinge satin nickel	
change of hinge color to white or black	
change of hinge color to gold	
change of magnetic lock color to white, black or gold	
non-rebated lock with latch (silver, white, black or gold) - NEW	

REVES SYSTEM (reverse rebate)

additional concealed TE hinge, silver	
change of TE hinge color to white or black	
change of TE hinge color to gold	

*dimension tolerance +/- 2 mm

SONATA

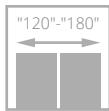
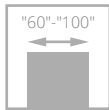

W1 / VD1



W2 / VD2



W4 / VD4



W5 / VD5



W6 / VD6



W7 / VD7



W8 / VD8



W09 / VD9



W10 / VD10



W11 / VD11



W12 / VD12

NEW VERSION

LINTEL PANEL (p. 249)



INTERIOR DOORS PANEL TYPE LAMINATED

DOOR FRAMES



fixed POL-SKONE system



adjustable DIN system



adjustable DIN SOLID



fixed metal



adjustable metal



adjustable AQUA DIN



adjustable REVES system



fixed DUO



adjustable DIN DUO



adjustable DIN DUO SOLID



adjustable VERTIGO



fixed metal



adjustable metal



adjustable AQUA DIN DUO



SONATA door, version W2, adjustable door frame VERTIGO



aluminum decors on the surface of the door leaf in matt copper, matt gold color (version W09, W10, W11, W12)



aluminum decors on the surface of the door leaf in black matt, chrome matt color (version W09, W10, W11, W12)

COLOR RANGE – pp. 303-310



aluminum decors on the surface of the door leaf in chrome gloss (not applicable to versions W4, W6), black, gold gloss (option) – p. 290



aluminum decors on the surface of the door leaf in chrome matt color (standard)

INCLUDED IN THE PRICE OF THE DOOR

The structure of the door leaf consists of a wooden stile and rail, filled with a perforated board.

aluminum decors with a width of 25 mm and 10 mm in chrome matt, black matt, copper matt, gold matt color - versions W09, W10, W11
 aluminum decors with a width of 25 mm in chrome matt, black matt, copper matt, gold matt color - version W12; aluminum decors with a width of 7.2 mm in black, chrome gloss (not applicable to versions W4, W6), gold gloss, chrome matt - versions W1-W8

no possibility to use a ventilation gap - versions W8, W09, W10, W11, W12

REBATED SYSTEM

visible hinge silver galvanized "60"- "80" - 2 pcs., "90" - 3 pcs.
 type K - for door frame DIN system, type C - for wooden door frame, type M - for metal door frame
 silver latch-bolt lock: for key, cylinder, bathroom lock, without keyhole

NON-REBATED SYSTEM

concealed satin nickel hinge "60"- "70" - 2 pcs., "80" "90" - 3 pcs.
 magnetic lock, satin chrome: for key, cylinder, bathroom lock, without keyhole

FOR EXTRA CHARGE

- non-standard door sizes p. 296
- door closers, electric strikes pp. 281, 283
- reinforcement for door closer
- solid chipboard filling (3rd hinge recommended)
- stile and rail allowing self-shortening up to 50 mm (not applicable to W8, W09, W10, W11, W12)
- stile and rail allowing self-shortening up to 90 mm (not applicable to W8, W09, W10, W11, W12)
- in the case of a door leaf with a door closer and a DIN or metal door frame, T type hinges should be used in the following quantities: "60"- "80" – 3 pcs.; "90"- "100" – 4 pcs.; extra charge for an additional T type hinge

drop seal	
heat recovery ventilation	without extra charge
ventilation undercut (pp. 286-287)	
sliding systems	pp. 168-177
aluminum edge (non-rebated system)	
edge of the door leaf in black, grey or graphite color	without extra charge

REBATED SYSTEM

- additional visible hinge type M silver galvanized
- additional visible hinge type M black
- additional visible hinge type K, type C silver galvanized or black
- change of lock color to black

NON-REBATED SYSTEM

- additional concealed hinge satin nickel
- change of hinge color to white or black
- change of hinge color to gold
- change of magnetic lock color to white, black or gold
- non-rebated lock with latch (silver, white, black or gold) - **NEW**

REVES SYSTEM (reverse rebate)

- additional concealed TE hinge, silver
- change of TE hinge color to white or black
- change of TE hinge color to gold

ADORE

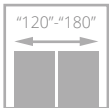
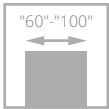

V01



V1SD



V02



V2SD

TRANSOM PANEL (p. 250)



DOOR FRAMES



fixed POL-SKONE system



adjustable DIN system



adjustable DIN SOLID



fixed metal



adjustable metal



adjustable AQUA DIN



adjustable REVES system



fixed DUO



adjustable DIN DUO



adjustable DIN DUO SOLID



adjustable VERTIGO



fixed metal



adjustable metal



adjustable AQUA DIN DUO



decorative strip

ADORE door, version V01, adjustable DIN SYSTEM door frame

COLOR RANGE – pp. 303-310

UNI MAT PLUS	640 graphite	641 titano	642 white	643 beige	644 black
	645 lava	646 stone	648 moss	649 sage	
	650 grey	651 verde	652 platino		
LAMISTONE CPL	210 filo	211 fibra	212 lino		

INCLUDED IN THE PRICE OF THE DOOR

The structure of the door leaf consists of a wooden stile and rail, filled with a perforated board. Profile decorative frame with a width of 35 mm in the color of the door leaf. The UNI MAT PLUS surface is characterized by a special coating resistant to fingerprints.

for LAMISTONE CPL surfaces, the edge of the door leaf is the UNI MAT PLUS surface: color filo 210 - edge stone 646, color fibra 211 - edge lava 645, color lino 212 - edge titano 641

REBATED SYSTEM

visible hinge silver galvanized "60"- "80" - 2 pcs., "90" - 3 pcs.
type T - for DIN system and metal door frame,
type C - for wooden door frame
silver latch-bolt lock: for key, cylinder, bathroom lock, without keyhole

NON-REBATED SYSTEM

concealed hinge, satin nickel "60"- "80" - 2 pcs., "90" - 3 pcs.
magnetic lock, satin chrome: for key, cylinder, bathroom lock, without keyhole

SYSTEM HARMONY

the opening angle of the door leaf is maximum 80° - above a wall thickness of 135 mm

FOR EXTRA CHARGE

non-standard door sizes p. 296

REBATED SYSTEM

additional visible hinge type M silver galvanized
additional visible hinge type M black
additional visible hinge type K, type C silver galvanized or black
change of lock color to black
door closers, electric strikes pp. 281, 283
drop seal
heat recovery ventilation (applies to doors of standard height)
ventilation undercut
sliding systems pp. 168-177

NON-REBATED SYSTEM

additional concealed hinge satin nickel
change of hinge color to white or black
change of hinge color to gold
change of magnetic lock color to white, black or gold
non-rebated lock with latch (silver, white, black or gold) - **NEW**
REVES SYSTEM (reverse rebate) above the ZW4 range, the door opening angle is 80°, number of hinges "60"- "80" - 2 pcs., "90" - 3 pcs.
additional concealed TE hinge, silver
change of TE hinge color to white or black
change of TE hinge color to gold

EMPORE

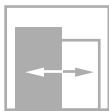
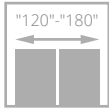
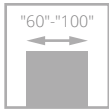

V01



V02



V03



V04



V05

DOOR FRAMES



fixed POL-SKONE system



adjustable DIN system



fixed metal



adjustable metal



adjustable AQUA DIN



adjustable REVES system



fixed DUO



adjustable DIN DUO



adjustable VERTIGO

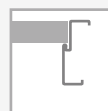

fixed metal



adjustable metal



adjustable AQUA DIN DUO



frame profile

EMPORE door, version V01, adjustable DIN SYSTEM door frame

COLOR RANGE – pp. 303-310

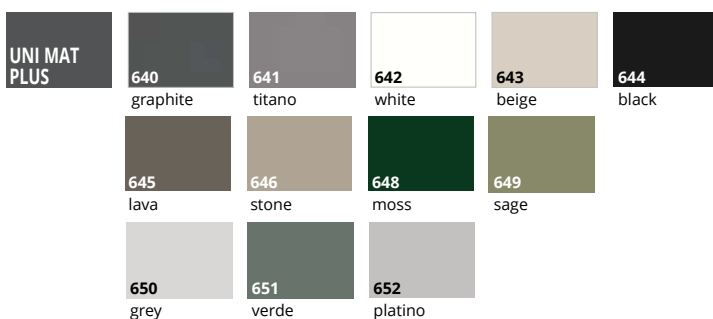

INCLUDED IN THE PRICE OF THE DOOR

The structure of the door leaf consists of a wooden stile and rail, filled with a perforated board. Decorative profile frame in the color of the door leaf. The UNI MAT PLUS surface is characterized by a special coating resistant to fingerprints.

REBATED SYSTEM

visible hinge silver galvanized "60"- "80" - 2 pcs., "90" - 3 pcs.
type K - for door frame DIN system, type C - for wooden door frame, type M - for metal door frame
silver latch-bolt lock: for key, cylinder, bathroom lock, without keyhole

NON-REBATED SYSTEM

concealed hinge, satin nickel "60"- "80" - 2 pcs., "90" - 3 pcs.
magnetic lock, satin chrome: for key, cylinder, bathroom lock, without keyhole

FOR EXTRA CHARGE

non-standard door sizes p. 296

REBATED SYSTEM

additional visible hinge type M silver galvanized
additional visible hinge type M black
additional visible hinge type K, type C silver galvanized or black
change of lock color to black
door closers, electric strikes pp. 281, 283
reinforcement for door closer
drop seal
heat recovery ventilation (applies to doors of standard height)
ventilation undercut
sliding systems pp. 168-177

NON-REBATED SYSTEM

additional concealed hinge satin nickel
change of hinge color to white or black
change of hinge color to gold
change of magnetic lock color to white, black or gold
non-rebated lock with latch (silver, white, black or gold) - **NEW**
REVES SYSTEM (reverse rebate) above the ZW4 range, the door opening angle is 80°
additional concealed TE hinge, silver
change of TE hinge color to white or black
change of TE hinge color to gold

DUE to the decorative frame on the door leaf, the maximum door opening angle in the HARMONY system from a wall thickness of 135 mm is 80°

MAESTO

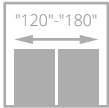
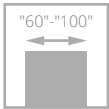

W01 / VD1



W02 / VD2



W03 / VD3

DOOR FRAMES



adjustable
DIN system



adjustable
DIN SOLID



fixed metal



adjustable metal



adjustable
AQUA DIN



adjustable
REVES system



adjustable
DIN DUO



adjustable
DIN DUO SOLID



adjustable
VERTIGO



fixed metal



adjustable metal



adjustable
AQUA DIN DUO



MAESTO door, version W02, adjustable DIN door frame



profile of the decorative frame



dedicated handle in copper color
- p. 292

COLOR RANGE - pp. 303-310

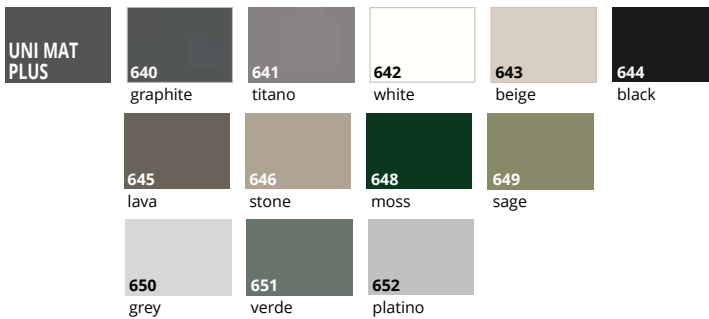

INCLUDED IN THE PRICE OF THE DOOR
The structure of the door leaf consists of a wooden stile and rail, filled with a perforated board. Profile decorative frame with a width of 30 mm in the color of the door leaf. The UNI MAT PLUS surface is characterized by a special coating resistant to fingerprints.
decorative aluminum decors in matt copper, matt gold or matt black color with a width of 25 mm
REBATED SYSTEM
visible black hinge "60"- "80" - 2 pcs., "90" - 3 pcs.
type T - for DIN system and metal door frame, color white 642 - hinges in silver color
black latch-bolt lock, silver: for key, cylinder, bathroom lock, without keyhole, color white 642 - lock in silver color
NON-REBATED SYSTEM
concealed black hinge "60"- "80" - 2 pcs., "90" - 3 pcs. color white 642 - hinges in white color
black magnetic lock: for key, cylinder, bathroom lock, without keyhole, color white 642 - lock in white color
SYSTEM HARMONY ODW
the opening angle of the door leaf is maximum 80° above a wall thickness of 115 mm

FOR EXTRA CHARGE	
non-standard door sizes	p. 296
door closers, electric strikes	pp. 281, 283
drop seal	
heat recovery ventilation (applies to doors of standard height)	
ventilation undercut	
sliding systems	pp. 168-177
REBATED SYSTEM	
additional visible hinge type T silver	
additional visible hinge type T black	
change of T type hinge color to black	
change of lock color to black	
NON-REBATED SYSTEM	
additional concealed hinge satin nickel	
change of hinge color to white or black	
change of hinge color to gold	
change of magnetic lock color to white or black	without extra charge
non-rebated lock with latch (silver, white, black or gold) - NEW	
REVES SYSTEM (reverse rebate) above the ZW3 range, the door opening angle is 80°	
additional concealed TE hinge, silver	
change of TE hinge color to white or black	
change of TE hinge color to gold	

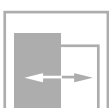
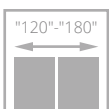
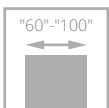

VD9



VD10



VD11



VD12

LINTEL PANEL (p. 249)



DOOR FRAMES



fixed POL-SKONE system



adjustable DIN system



adjustable DIN SOLID



fixed metal



adjustable metal



adjustable AQUA DIN



adjustable REVES system



fixed DUO



adjustable DIN DUO



adjustable DIN DUO SOLID



adjustable VERTIGO



fixed metal



adjustable metal



adjustable AQUA DIN DUO



SALEA door, version VD9, adjustable DIN door frame



aluminum decors on the surface of the door leaf in matt chrome color



aluminum decorative elements on the surface of the door leaf in matt gold color



aluminum decorative elements on the surface of the door leaf in matt copper color



aluminum decorative elements on the surface of the door leaf in matt black color

COLOR RANGE - pp. 303-310

LAMISTONE CPL	213 super white	241 sandy elm V*	242 grey elm V*	260 white oak	250 Terra oak	233 Salinas oak
	289 grey	263 premium walnut	231 Halif oak	531 anthracite		
SILKSTONE	230 gran oak	276 Polish oak	NEW 290 Royal oak	293 Royal anthracite	295 Royal merbau	297 Royal nougat

* while stocks last

INCLUDED IN THE PRICE OF THE DOOR

The structure of the door leaf consists of a wooden stile and rail, filled with a layer of "honeycomb" structure

aluminum decorative elements with a width of 25 mm and 10 mm in matt black, matt copper, matt gold colors - versions VD09, VD10, VD11

aluminum decorative elements with a width of 25 mm in matt black, matt copper, matt gold colors - version VD12

REBATED SYSTEM

visible hinge silver galvanized "60"- "80" - 2 pcs., "90" - 3 pcs.

type K - for door frame DIN system, type C - for wooden door frame, type M - for metal door frame

silver latch-bolt lock: for key, cylinder, bathroom lock, without keyhole

NON-REBATED SYSTEM

concealed hinge satin nickel "60"- "70" - 2 pcs., "80"- "90" - 3 pcs.

magnetic lock, satin chrome: for key, cylinder, bathroom lock, without keyhole

FOR EXTRA CHARGE

non-standard door sizes	p. 296
door closers, electric strikes	pp. 281, 283
drop seal	
heat recovery ventilation	without extra charge
ventilation undercut (pp. 286-287)	
sliding systems	pp. 168-177
aluminum edge (non-rebated system)	

REBATED SYSTEM

additional visible hinge type M silver galvanized

additional visible hinge type M black

additional visible hinge type K, type C silver galvanized or black

change of lock color to black

in the case of a door leaf with a door closer and a DIN or metal door frame, type T hinges should be used in the following quantities: "60"- "80" - 3 pcs.; "90"- "110" - 4 pcs.; extra charge for additional hinge type T

NON-REBATED SYSTEM

additional concealed hinge satin nickel

change of hinge color to white or black

change of hinge color to gold

change of magnetic lock color to white, black or gold

non-rebated lock with latch (silver, white, black or gold) - **NEW**

REVES SYSTEM (reverse rebate)

additional concealed TE hinge, silver

change of TE hinge color to white or black

change of TE hinge color to gold

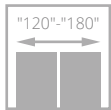
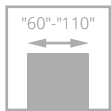

B0 / V00



B1 / VD11



A01 / V1SA



A02 / V2SA

DOOR FRAMES



fixed POL-SKONE system



adjustable DIN system



adjustable DIN SOLID



fixed metal



adjustable metal



adjustable AQUA DIN



fixed DUO



adjustable DIN DUO



adjustable DIN DUO SOLID



adjustable VERTIGO



fixed metal



adjustable metal



adjustable AQUA DIN DUO



ETIUDA door, version B1 (door on the left), version A01 (door on the right), fixed door frame SYSTEM POL-SKONE



aluminum decorative strips



option: aluminum decorative strips in black color

COLOR RANGE – pp. 303-310



* while stocks last



option: aluminum glazing beads in black color

INCLUDED IN THE PRICE OF THE DOOR	
The structure of the door leaf consists of a wooden stile and rail, filled with a layer of "honeycomb" structure (version B1 filled with solid board).	
The edge of the door leaf without the upper rebate (in the rebated and non-rebated system). Aluminum decorative strips (version B1), decorative glazing beads in silver or black color (versions A01, A02).	
tempered glass white matt or brown matt with a thickness of 6 mm (glazing width in version A01-58 mm, A02-208 mm*)	
it is not possible to use glass in black color	
REBATED SYSTEM	
visible hinge silver galvanized "60"- "80" - 2 pcs., "90" - 3 pcs.	
type K - for door frame DIN system, type C - for wooden door frame, type M - for metal door frame	
silver latch-bolt lock: for key, cylinder, bathroom lock, without keyhole	
NON-REBATED SYSTEM	
concealed hinge, satin nickel "60"- "80" - 2 pcs., "90" - 3 pcs.	
magnetic lock, satin chrome: for key, cylinder, bathroom lock, without keyhole	
FOR EXTRA CHARGE	
non-standard door sizes	p. 296
tempered glass graphite or transparent with a thickness of 6 mm	
change of color of decorative strips to black	
stile and rail (allowing self-shortening up to 50 mm) (applies to version B0)	
stile and rail (allowing self-shortening up to 90 mm) (applies to version B0)	
perforated chipboard filling (applies to versions B0, A01, A02)	

*dimension tolerance +/- 2 mm

solid chipboard filling (applies to versions B0, A01, A02)	
door closers, electric strikes	pp. 281, 283
reinforcement for door closer (does not apply to versions A01, A02)	
drop seal - does not apply to versions A01 and A02	
heat recovery ventilation	without extra charge
ventilation undercut (pp. 286-287)	
ventilation undercut version A02	
sliding systems (not applicable to version A01)	pp. 168-177
aluminum edge (non-rebated system)	
edge of the door leaf in black, grey or graphite color	without extra charge
REBATED SYSTEM	
additional visible hinge type M silver galvanized	
additional visible hinge type M black	
additional visible hinge type K, type C galvanized silver or black	
change of lock color to black	
in the case of a door leaf with a door closer and a DIN or metal door frame, T-type hinges should be used in the following quantities: "60"- "80" – 3 pcs., "90"- "110" – 4 pcs., extra charge for an additional T-type hinge.	
NON-REBATED SYSTEM	
additional concealed hinge satin nickel	
change of hinge color to white or black	
change of hinge color to gold	
change of magnetic lock color to white, black or gold	
non-rebated lock with latch (silver, white, black or gold) - NEW	

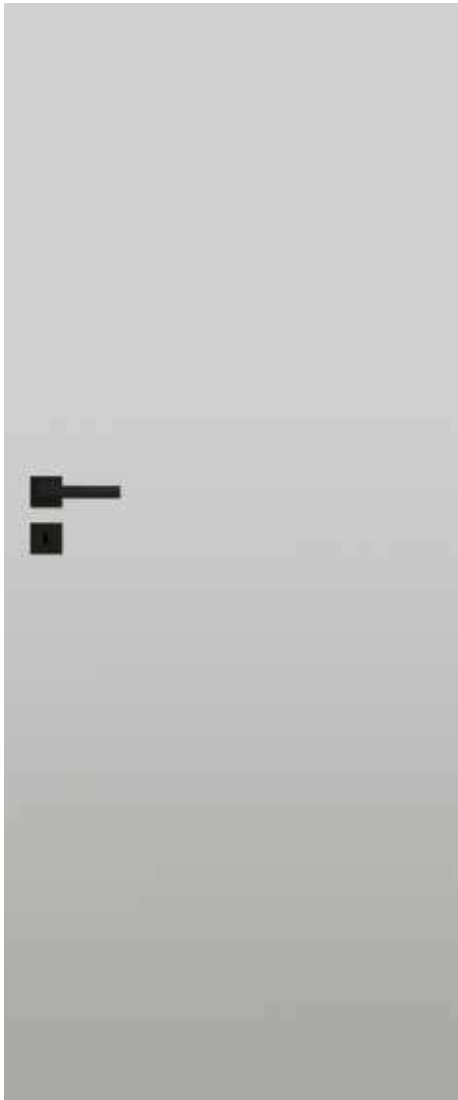
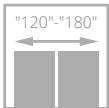
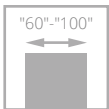

W00 / V01

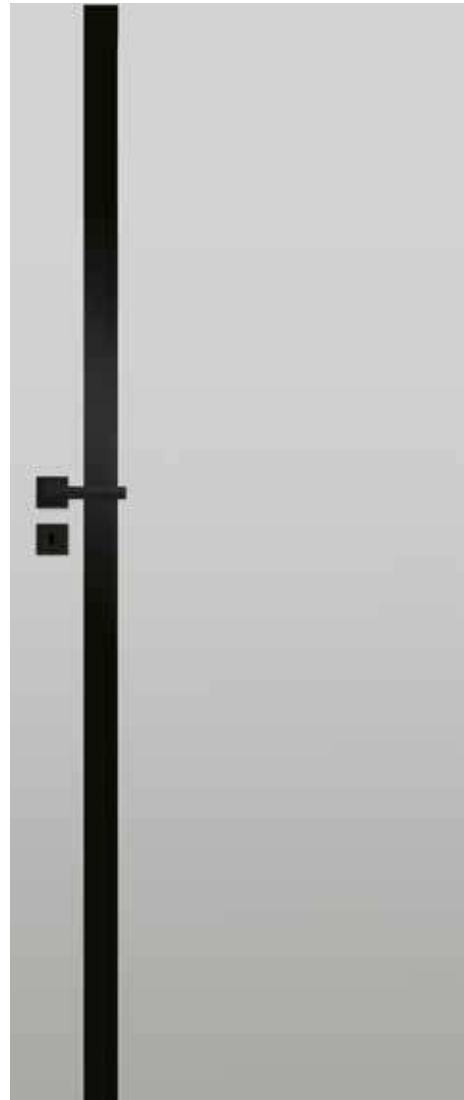

A01 / V1SA

DOOR FRAMES



adjustable
DIN system



adjustable
DIN SOLID



fixed metal



adjustable metal



adjustable
AQUA DIN



adjustable
REVES system



adjustable
DIN DUO



adjustable
DIN DUO SOLID



adjustable
VERTIGO



fixed metal



adjustable metal



adjustable
AQUA DIN DUO



ZENN door, version A01, adjustable DIN door frame

COLOR RANGE – pp. 303-310

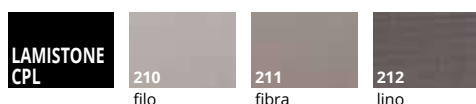

filo color – stone edge



fibra color – lava edge

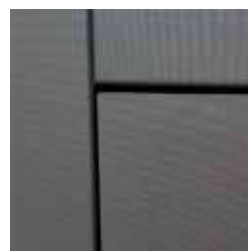

lino color – titano edge

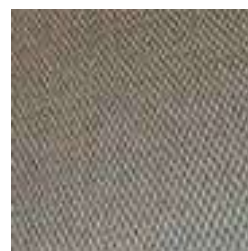

unique surface CPL 0.15
with the structure of **linen fabric** interwoven with **metallic sheen**

INCLUDED IN THE PRICE OF THE DOOR

The structure of the door leaf consists of a wooden stile and rail, filled with a perforated board. The door frame is always in black color. Unique CPL 0.15 surface with the structure of linen fabric interwoven with metallic sheen.

laminated glass VSG 44.4 in matt black color with a thickness of 8.4 mm

the edge of the door leaf is the UNI MAT PLUS surface: filo color 210 - stone edge 646, fibra color 211 - lava edge 645, lino color 212 - titano edge 641

visible black hinge "60"- "80" - 2 pcs., "90" - 3 pcs.

type T - for DIN system and metal door frame

black latch-bolt lock: for key, cylinder, bathroom lock, without keyhole

NON-REBATED SYSTEM

concealed black hinge "60"- "80" - 2 pcs., "90" - 3 pcs.

black magnetic lock: for key, cylinder, bathroom lock, without keyhole

FOR EXTRA CHARGE

non-standard door sizes p. 296

solid chipboard filling - applies to version W00 (third hinge recommended)

stile and rail (enabling self-shortening up to 90 mm)

door closers, electric strikes pp. 281, 283

reinforcement for door closer

drop seal

heat recovery ventilation without extra charge

ventilation undercut (pp. 286-287)

sliding systems (not applicable to version A01) pp. 168-177

REBATED SYSTEM

additional visible hinge type T black

NON-REBATED SYSTEM

additional concealed black hinge

non-rebated lock with black latch - **NEW**

REVES SYSTEM (reverse rebate)

additional concealed TE black hinge

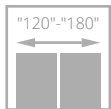
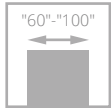

for door leaves with ventilation option



01 / V01



0156 / V156



02 / V02



0256 / V256



05 / V05



0558 / V558



08 / V08



08510 / V8510

DOOR FRAMES



fixed POL-SKONE system



adjustable DIN system



fixed metal



adjustable metal



adjustable AQUA DIN



adjustable REVES system



fixed DUO



adjustable DIN DUO



adjustable VERTIGO



fixed metal



adjustable metal



adjustable AQUA DIN DUO



door MODERN, version 02 with crown, adjustable DIN SYSTEM door frame



profile of the stile and rail of the door leaf



concealed hinge DUO white – option for the system. non-rebated system



painting trim and crowns

COLOR RANGE – pp. 303-310

PAINTED	MONO1 MAT	MONO2 MAT	MONO3 MAT
001 RAL white 9003	OMA RAL 9010 matt OMB RAL 9016 matt OME RAL 9001 matt OMF RAL 9002 matt OMS RAL 7047 grey matt OMG RAL 7035 matt OMH RAL 7004 matt OM6 NCS S 2005-Y50R beige matt OMD NCS S 1502-Y50R light beige matt OMC NCS S 1002-Y50R sand grey matt 000 NCS S 0500-N white OMI NCS S 0502-Y matt	OM7 NCS S 4010-G50Y sage matt OM4 RAL 5011 indigo matt OM1 RAL 5014 sky blue matt OMJ RAL 1015 matt OMK RAL 7044 matt OML RAL 7038 matt OND RAL 7037 matt OMM NCS S 0300-N matt OMN NCS S 1502-Y matt OMO NCS S 1000-N matt OMP NCS S 1002-Y matt OMQ NCS S 1500-N matt OMR NCS S 3005-Y50R matt OMS NCS S 4005-Y50R matt OMT NCS S 2005-R80B matt OMU NCS S 1502-R matt 002 RAL 9005 BLACK black	ON1 NCS S 8000-N matt ON2 RAL 7016 matt ON3 RAL 7024 matt ON4 NCS S 8500-N matt ON6 NCS S 7000-N matt ON7 NCS S 6005-Y50R matt ON8 RAL 1019 matt ON9 RAL 1013 matt ONA RAL 6003 matt ONB RAL 6013 matt ONC RAL 6012 matt

INCLUDED IN THE PRICE OF THE DOOR

Solid construction made of a wooden stile and rail. Three-layer painting system ensuring color durability for many years. The bottom edge of the door leaf is protected with a special impregnating agent against moisture.

wooden muntins

glass white matt or transparent with a thickness of 4 mm

color black RAL 9005

magnetic lock, lock faceplate and concealed black hinges

REBATED SYSTEM

visible hinge silver galvanized "60"- "80" - 2 pcs., "90" - 3 pcs.

type K – for door frame DIN system, type C – for wooden door frame, type M – for metal door frame

silver latch-bolt lock: for key, cylinder, bathroom lock, without keyhole

NON-REBATED SYSTEM

concealed hinge, satin nickel "60"- "80" - 2 pcs., "90" - 3 pcs.

magnetic lock, satin chrome: for key, cylinder, bathroom lock, without keyhole

FOR EXTRA CHARGE

non-standard door sizes

p. 296

door closers, electric strikes

pp. 281, 283

drop seal

heat recovery ventilation

without extra charge

ventilation undercut

sliding systems

pp. 168-177

REBATED SYSTEM

additional visible hinge type M silver galvanized

additional visible hinge type M black

additional visible hinge type K, type C galvanized silver or black

change of lock color to black

NON-REBATED SYSTEM

additional concealed hinge satin nickel

change of hinge color to white or black

change of hinge color to gold

change of magnetic lock color to white, black or gold

non-rebated lock with latch (silver, white, black or gold) - **NEW**

REVES SYSTEM (reverse rebate)

additional concealed TE hinge, silver

change of TE hinge color to white or black

change of TE hinge color to gold

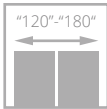
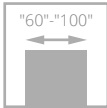

W00



V1SP



OSD / V1SD

DOOR FRAMES



fixed POL-SKONE system



adjustable DIN system



fixed metal



adjustable metal



adjustable AQUA DIN



adjustable REVES system



fixed DUO



adjustable DIN DUO



adjustable VERTIGO



fixed metal



adjustable metal



adjustable AQUA DIN DUO



VILANO door, version W00, adjustable DIN door frame



concealed hinge DUO white – option for the system. non-rebated system



frame profile

COLOR RANGE – pp. 303-310

PAINTED	MONO1 MAT	MONO2 MAT	MONO3 MAT
001 RAL white 9003	OMA RAL 9010 matt OMB RAL 9016 matt OME RAL 9001 matt OMF RAL 9002 matt OMS RAL 7047 grey matt OMG RAL 7035 matt OMH RAL 7004 matt OM6 NCS S 2005-Y50R beige matt OMD NCS S 1502-Y50R light beige matt OMC NCS S 1002-Y50R sand grey matt 000 NCS S 0500-N white OMI NCS S 0502-Y matt	OM7 NCS S 4010-G50Y sage matt OM4 RAL 5011 indigo matt OM1 RAL 5014 sky blue matt OMJ RAL 1015 matt OMK RAL 7044 matt OML RAL 7038 matt OND RAL 7037 matt OMM NCS S 0300-N matt OMN NCS S 1502-Y matt OMO NCS S 1000-N matt OMP NCS S 1002-Y matt OMQ NCS S 1500-N matt OMR NCS S 3005-Y50R matt OMS NCS S 4005-Y50R matt OMT NCS S 2005-R80B matt OMU NCS S 1502-R matt 002 RAL 9005 BLACK black	ON1 NCS S 8000-N matt ON2 RAL 7016 matt ON3 RAL 7024 matt ON4 NCS S 8500-N matt ON6 NCS S 7000-N matt ON7 NCS S 6005-Y50R matt ON8 RAL 1019 matt ON9 RAL 1013 matt ONA RAL 6003 matt ONB RAL 6013 matt ONC RAL 6012 matt



panel with finished edge glued to the glass – version V1SP

INCLUDED IN THE PRICE OF THE DOOR
Solid construction made of a wooden stile and rail. Three-layer painting system ensuring color durability for many years. The bottom edge of the door leaf is protected with a special impregnating agent against moisture.
tempered glass white matt, 6 mm thick (transparent glass cannot be used)
color black RAL 9005
magnetic lock, lock faceplate and concealed black hinges
REBATED SYSTEM
visible hinge silver galvanized "60"- "80" - 2 pcs., "90" - 3 pcs.
type K – for door frame DIN system, type C – for wooden door frame, type M – for metal door frame
silver latch-bolt lock: for key, cylinder, bathroom lock, without keyhole
NON-REBATED SYSTEM
concealed hinge, satin nickel "60"- "80" - 2 pcs., "90" - 3 pcs.
magnetic lock, satin chrome: for key, cylinder, bathroom lock, without keyhole

FOR EXTRA CHARGE	
non-standard door sizes	p. 296
door closers, electric strikes	pp. 281, 283
drop seal	
heat recovery ventilation	without extra charge
ventilation undercut	
sliding systems	pp. 168-177
REBATED SYSTEM	
additional visible hinge type M silver galvanized	
additional visible hinge type M black	
additional visible hinge type K, type C silver galvanized or black	
change of lock color to black	
NON-REBATED SYSTEM	
additional concealed hinge satin nickel	
change of hinge color to white or black	
change of hinge color to gold	
change of magnetic lock color to white, black or gold	
non-rebated lock with latch (silver, white, black or gold) - NEW	
REVES SYSTEM	(reverse rebate) above the ZW4 range, the door opening angle is 88°
additional concealed TE hinge, silver	
change of TE hinge color to white or black	
change of TE hinge color to gold	

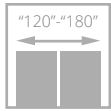
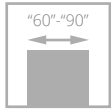

for door leaves with ventilation option



W00



W01



W03



W04

DOOR FRAMES



fixed POL-SKONE system



adjustable DIN system



adjustable AQUA DIN



adjustable REVES system



fixed DUO



adjustable DIN DUO



adjustable VERTIGO



adjustable AQUA DIN DUO



milling on the surface of the door leaf

MODESTO door, version W03, adjustable DIN door frame

COLOR RANGE – pp. 303-310

PAINTED	MONO1 MAT	MONO2 MAT	MONO3 MAT
001 RAL white 9003	OMA RAL 9010 matt OMB RAL 9016 matt OME RAL 9001 matt OMF RAL 9002 matt OM5 RAL 7047 grey matt OMG RAL 7035 matt OMH RAL 7004 matt OM6 NCS S 2005-Y50R beige matt OMD NCS S 1502-Y50R light beige matt OMC NCS S 1002-Y50R sand grey matt 000 NCS S 0500-N white OMI NCS S 0502-Y matt	OM7 NCS S 4010-G50Y sage matt OM4 RAL 5011 indigo matt OM1 RAL 5014 sky blue matt OMJ RAL 1015 matt OMK RAL 7044 matt OML RAL 7038 matt OND RAL 7037 matt OMM NCS S 0300-N matt OMN NCS S 1502-Y matt OMO NCS S 1000-N matt OMP NCS S 1002-Y matt OMQ NCS S 1500-N matt OMR NCS S 3005-Y50R matt OMS NCS S 4005-Y50R matt OMT NCS S 2005-R80B matt OMU NCS S 1502-R matt 002 RAL 9005 BLACK black	ON1 NCS S 8000-N matt ON2 RAL 7016 matt ON3 RAL 7024 matt ON4 NCS S 8500-N matt ON6 NCS S 7000-N matt ON7 NCS S 6005-Y50R matt ON8 RAL 1019 matt ON9 RAL 1013 matt ONA RAL 6003 matt ONB RAL 6013 matt ONC RAL 6012 matt

INCLUDED IN THE PRICE OF THE DOOR
Solid construction with a wooden frame, panel thickness 12 mm. Three-layer painting system ensuring color durability for many years. The bottom edge of the door leaf is protected with a special impregnating agent against moisture.
color black RAL 9005 magnetic lock, lock faceplate and concealed black hinges
REBATED SYSTEM visible hinge silver galvanized "60"- "80" - 2 pcs., "90" - 3 pcs. type K – for door frame DIN system, type C – for wooden door frame latch-bolt lock silver: for key, cylinder, bathroom lock, without keyhole
NON-REBATED SYSTEM concealed hinge satin nickel "60"- "80" - 2 pcs., "90" - 3 pcs. magnetic lock satin chrome: for key, cylinder, bathroom lock, without keyhole

FOR EXTRA CHARGE	
non-standard door sizes	p. 296
door closers, electric strikes	pp. 281, 283
drop seal	
heat recovery ventilation	without extra charge
ventilation undercut	
sliding systems	pp. 168-177
REBATED SYSTEM	
additional visible hinge type K, type C silver galvanized or black	
change of lock color to black	
NON-REBATED SYSTEM	
additional concealed hinge satin nickel	
change of hinge color to white or black	
change of hinge color to gold	
change of magnetic lock color to white, black or gold	
non-rebated lock with latch (silver, white, black or gold) - NEW	
REVES SYSTEM (reverse rebate)	
additional concealed TE hinge, silver	
change of TE hinge color to white or black	
change of TE hinge color to gold	

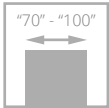

for door leaves with ventilation option



W00



DOOR FRAMES



fixed system POL-SKONE



adjustable DIN system



adjustable AQUA DIN



adjustable REVES system



fixed DUO



adjustable DIN DUO

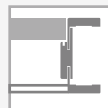

adjustable VERTIGO



adjustable AQUA DIN DUO



profile of the stile and rail of the door leaf

PALAZZO door, version W00, adjustable DIN door frame

COLOR RANGE – pp. 303-310

PAINTED	MONO1 MAT	MONO2 MAT	MONO3 MAT
001 RAL white 9003	OMA RAL 9010 matt OMB RAL 9016 matt OME RAL 9001 matt OMF RAL 9002 matt OMS RAL 7047 grey matt OMG RAL 7035 matt OMH RAL 7004 matt OM6 NCS S 2005-Y50R beige matt OMD NCS S 1502-Y50R light beige matt OMC NCS S 1002-Y50R sand grey matt OOO NCS S 0500-N white OMI NCS S 0502-Y matt	OM7 NCS S 4010-G50Y sage matt OM4 RAL 5011 indigo matt OM1 RAL 5014 sky blue matt OMJ RAL 1015 matt OMK RAL 7044 matt OML RAL 7038 matt OND RAL 7037 matt OMM NCS S 0300-N matt OMN NCS S 1502-Y matt OMO NCS S 1000-N matt OMP NCS S 1002-Y matt OMQ NCS S 1500-N matt OMR NCS S 3005-Y50R matt OMS NCS S 4005-Y50R matt OMT NCS S 2005-R80B matt OMU NCS S 1502-R matt 002 RAL 9005 BLACK black	ON1 NCS S 8000-N matt ON2 RAL 7016 matt ON3 RAL 7024 matt ON4 NCS S 8500-N matt ON6 NCS S 7000-N matt ON7 NCS S 6005-Y50R matt ON8 RAL 1019 matt ON9 RAL 1013 matt ONA RAL 6003 matt ONB RAL 6013 matt ONC RAL 6012 matt

INCLUDED IN THE PRICE OF THE DOOR

Solid construction made of a wooden stile and rail. Three-layer painting system ensuring color durability for many years. The bottom edge of the door leaf is protected with a special impregnating agent against moisture.

color black RAL 9005

magnetic lock, lock faceplate and concealed black hinges

REBATED SYSTEM

visible hinge silver galvanized "70" - 2 pcs., "80"- "90" - 3 pcs.
type K – for door frame DIN system, type C – for wooden door frame
silver latch-bolt lock: for key, cylinder, bathroom lock, without keyhole

NON-REBATED SYSTEM

concealed hinge satin nickel "70" - 2 pcs., "80"- "90" - 3 pcs.
magnetic lock, satin chrome: for key, cylinder, bathroom lock, without keyhole

FOR EXTRA CHARGE

non-standard door sizes

p. 296

door closers, electric strikes

pp. 281, 283

drop seal

heat recovery ventilation

without extra charge

ventilation undercut

sliding systems

pp. 168-177

REBATED SYSTEM

additional visible hinge type K, type C silver galvanized or black

change of lock color to black

NON-REBATED SYSTEM

additional concealed hinge satin nickel

change of hinge color to white or black

change of hinge color to gold

change of magnetic lock color to white, black or gold

non-rebated lock with latch (silver, white, black or gold) - **NEW**

REVES SYSTEM (reverse rebate)

additional concealed TE hinge, silver

change of TE hinge color to white or black

change of TE hinge color to gold

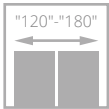
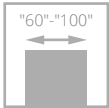

W00 / V01



OSD / V1SD



V1SP



W02 / V02



W02S1 / V2SD

DOOR FRAMES



fixed POL-SKONE system



adjustable DIN system



fixed metal



adjustable metal



adjustable AQUA DIN



adjustable REVES system



fixed DUO



adjustable DIN DUO



adjustable VERTIGO



fixed metal



adjustable metal



adjustable AQUA DIN DUO



VERTIGO door, version W00, adjustable DIN door frame

COLOR RANGE – pp. 303-310

PAINTED	MONO1 MAT	MONO2 MAT	MONO3 MAT
001 RAL white 9003	OMA RAL 9010 matt OMB RAL 9016 matt OME RAL 9001 matt OMF RAL 9002 matt OMS RAL 7047 grey matt OMG RAL 7035 matt OMH RAL 7004 matt OM6 NCS S 2005-Y50R beige matt OMD NCS S 1502-Y50R light beige matt OMC NCS S 1002-Y50R sand grey matt 000 NCS S 0500-N white OMI NCS S 0502-Y matt	OM7 NCS S 4010-G50Y sage matt OM4 RAL 5011 indigo matt OM1 RAL 5014 sky blue matt OMJ RAL 1015 matt OMK RAL 7044 matt OML RAL 7038 matt OND RAL 7037 matt OMM NCS S 0300-N matt OMN NCS S 1502-Y matt OMO NCS S 1000-N matt OMP NCS S 1002-Y matt OMQ NCS S 1500-N matt OMR NCS S 3005-Y50R matt OMS NCS S 4005-Y50R matt OMT NCS S 2005-R80B matt OMU NCS S 1502-R matt 002 RAL 9005 BLACK black	ON1 NCS S 8000-N matt ON2 RAL 7016 matt ON3 RAL 7024 matt ON4 NCS S 8500-N matt ON6 NCS S 7000-N matt ON7 NCS S 6005-Y50R matt ON8 RAL 1019 matt ON9 RAL 1013 matt ONA RAL 6003 matt ONB RAL 6013 matt ONC RAL 6012 matt



frame



concealed hinge DUO white – option for the non-rebated system



standard joining of trims at a 45° angle for DIN DUO door frame



panel with finished edge glued to the glass – version V1SP

INCLUDED IN THE PRICE OF THE DOOR

Solid construction made of a wooden stile and rail. Three-layer painting system ensuring color durability for many years. The bottom edge of the door leaf is protected with a special impregnating agent against moisture.

tempered glass white matt, 6 mm thick (transparent glass cannot be used)

color black RAL 9005

magnetic lock, lock faceplate and concealed black hinges

REBATED SYSTEM

visible hinge silver galvanized "60"- "80" - 2 pcs., "90" - 3 pcs.

type K – for door frame DIN system, type C – for wooden door frame,

type M – for metal door frame

silver latch-bolt lock: for key, cylinder, bathroom lock, without keyhole

NON-REBATED SYSTEM

concealed hinge, satin nickel "60"- "80" - 2 pcs., "90" - 3 pcs.

magnetic lock, satin chrome: for key, cylinder, bathroom lock, without keyhole

FOR EXTRA CHARGE

non-standard door sizes p. 296

tempered Antisol glass, grey (version V1SP)

tempered Antisol glass, dark grey, brown (version V1SP)

door closers, electric strikes pp. 281, 283

drop seal

heat recovery ventilation without extra charge

ventilation undercut

sliding systems pp. 168-177

REBATED SYSTEM

additional visible hinge type M silver galvanized

additional visible hinge type M black

additional visible hinge type K, type C galvanized silver or black

change of lock color to black

NON-REBATED SYSTEM

additional concealed hinge satin nickel

change of hinge color to white or black

change of hinge color to gold

change of magnetic lock color to white, black or gold

non-rebated lock with latch (silver, white, black or gold) - **NEW**

REVES SYSTEM (reverse rebate) above the ZW5 range, the door opening angle is 87°

additional concealed TE hinge, silver

change of TE hinge color to white or black

change of TE hinge color to gold

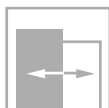
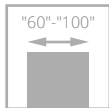

for door leaves with ventilation option



02 / V02



05 / V05



08 / V08



DOOR FRAMES



fixed system
POL-SKONE



adjustable
DIN system



adjustable
AQUA DIN



adjustable
REVES system



fixed DUO



adjustable
DIN DUO



adjustable
VERTIGO



adjustable
AQUA DIN DUO



profile of the stile and rail of the door leaf

MODENA door, version 08, adjustable DIN door frame

COLOR RANGE – pp. 303-310

PAINTED	MONO1 MAT	MONO2 MAT	MONO3 MAT
001 RAL white 9003	OMA RAL 9010 matt OMB RAL 9016 matt OME RAL 9001 matt OMF RAL 9002 matt OM5 RAL 7047 grey matt OMG RAL 7035 matt OMH RAL 7004 matt OM6 NCS S 2005-Y50R beige matt OMD NCS S 1502-Y50R light beige matt OMC NCS S 1002-Y50R sand grey matt 000 NCS S 0500-N white OMI NCS S 0502-Y matt	OM7 NCS S 4010-G50Y sage matt OM4 RAL 5011 indigo matt OM1 RAL 5014 sky blue matt OMJ RAL 1015 matt OMK RAL 7044 matt OML RAL 7038 matt OND RAL 7037 matt OMM NCS S 0300-N matt OMN NCS S 1502-Y matt OMO NCS S 1000-N matt OMP NCS S 1002-Y matt OMQ NCS S 1500-N matt OMR NCS S 3005-Y50R matt OMS NCS S 4005-Y50R matt OMT NCS S 2005-R80B matt OMU NCS S 1502-R matt 002 RAL 9005 BLACK black	ON1 NCS S 8000-N matt ON2 RAL 7016 matt ON3 RAL 7024 matt ON4 NCS S 8500-N matt ON6 NCS S 7000-N matt ON7 NCS S 6005-Y50R matt ON8 RAL 1019 matt ON9 RAL 1013 matt ONA RAL 6003 matt ONB RAL 6013 matt ONC RAL 6012 matt

INCLUDED IN THE PRICE OF THE DOOR
Solid construction made of a wooden stile and rail. Three-layer painting system ensuring color durability for many years. The bottom edge of the door leaf is protected with a special impregnating agent against moisture.
color black RAL 9005
magnetic lock, lock faceplate and concealed black hinges
REBATED SYSTEM
visible hinge silver galvanized "60"- "80" - 2 pcs., "90" - 3 pcs. type K – for door frame DIN system, type C – for wooden door frame, type M – for metal door frame silver latch-bolt lock: for key, cylinder, bathroom lock, without keyhole
NON-REBATED SYSTEM
concealed hinge, satin nickel "60"- "80" - 2 pcs., "90" - 3 pcs. magnetic lock, satin chrome: for key, cylinder, bathroom lock, without keyhole

FOR EXTRA CHARGE	
non-standard door sizes	p. 296
door closers, electric strikes	pp. 281, 283
drop seal	
heat recovery ventilation	without extra charge
ventilation undercut	
sliding systems	pp. 168-177
REBATED SYSTEM	
additional visible hinge type M silver galvanized	
additional visible hinge type M black	
additional visible hinge type K, type C silver galvanized or black	
change of lock color to black	
NON-REBATED SYSTEM	
additional concealed hinge satin nickel	
change of hinge color to white or black	
change of hinge color to gold	
change of magnetic lock color to white, black or gold	
non-rebated lock with latch (silver, white, black or gold) - NEW	
REVES SYSTEM (reverse rebate)	
additional concealed TE hinge, silver	
change of TE hinge color to white or black	
change of TE hinge color to gold	

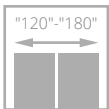
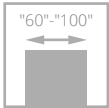

for door leaves with ventilation option



V08



V05



V02

DOOR FRAMES



fixed system
POL-SKONE



adjustable
DIN system



adjustable
AQUA DIN



adjustable
REVES system



fixed DUO



adjustable
DIN DUO

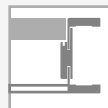

adjustable
VERTIGO



adjustable
AQUA DIN DUO



spatial panel with a thickness of 22 mm

PRINCESTONE door, version V08, adjustable DIN door frame

COLOR RANGE – pp. 303-310

PAINTED	MONO1 MAT	MONO2 MAT	MONO3 MAT
001 RAL white 9003	OMA RAL 9010 matt OMB RAL 9016 matt OME RAL 9001 matt OMF RAL 9002 matt OM5 RAL 7047 grey matt OMG RAL 7035 matt OMH RAL 7004 matt OM6 NCS S 2005-Y50R beige matt OMD NCS S 1502-Y50R light beige matt OMC NCS S 1002-Y50R sand grey matt 000 NCS S 0500-N white OMI NCS S 0502-Y matt	OM7 NCS S 4010-G50Y sage matt OM4 RAL 5011 indigo matt OM1 RAL 5014 sky blue matt OMJ RAL 1015 matt OMK RAL 7044 matt OML RAL 7038 matt OND RAL 7037 matt OMM NCS S 0300-N matt OMN NCS S 1502-Y matt OMO NCS S 1000-N matt OMP NCS S 1002-Y matt OMQ NCS S 1500-N matt OMR NCS S 3005-Y50R matt OMS NCS S 4005-Y50R matt OMT NCS S 2005-R80B matt OMU NCS S 1502-R matt 002 RAL 9005 BLACK black	ON1 NCS S 8000-N matt ON2 RAL 7016 matt ON3 RAL 7024 matt ON4 NCS S 8500-N matt ON6 NCS S 7000-N matt ON7 NCS S 6005-Y50R matt ON8 RAL 1019 matt ON9 RAL 1013 matt ONA RAL 6003 matt ONB RAL 6013 matt ONC RAL 6012 matt

INCLUDED IN THE PRICE OF THE DOOR

Solid construction made of a wooden stile and rail. Three-layer painting system ensuring color durability for many years. The bottom edge of the door leaf is protected with a special impregnating agent against moisture.

color black RAL 9005

magnetic lock, lock faceplate and concealed black hinges

REBATED SYSTEM

visible hinge silver galvanized "60"- "80" - 2 pcs., "90" - 3 pcs.

type K – for door frame DIN system, type C – for wooden door frame,

type M – for metal door frame

silver latch-bolt lock: for key, cylinder, bathroom lock, without keyhole

NON-REBATED SYSTEM

concealed hinge, satin nickel "60"- "80" - 2 pcs., "90" - 3 pcs.

magnetic lock, satin chrome: for key, cylinder, bathroom lock, without keyhole

FOR EXTRA CHARGE

non-standard door sizes

p. 296

door closers, electric strikes

pp. 281, 283

drop seal

heat recovery ventilation

without extra charge

ventilation undercut

sliding systems

pp. 168-177

REBATED SYSTEM

additional visible hinge type M silver galvanized

additional visible hinge type K, type C silver galvanized or black

change of lock color to black

NON-REBATED SYSTEM

additional concealed hinge satin nickel

change of hinge color to white or black

change of hinge color to gold

change of magnetic lock color to white, black or gold

non-rebated lock with latch (silver, white, black or gold) - **NEW**

REVES SYSTEM (reverse rebate)

additional concealed TE hinge, silver

change of TE hinge color to white or black

change of TE hinge color to gold

change of magnetic lock color to white, black or gold

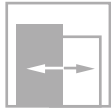
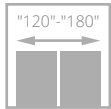
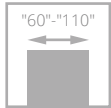

00 / V00



02 / V2S



03SD / V3SD



04 / V4SD



05 / V5SD

DOOR FRAMES



fixed POL-SKONE system



adjustable DIN system



fixed metal



adjustable metal



adjustable AQUA DIN



adjustable REVES system



fixed DUO



adjustable DIN DUO



adjustable VERTIGO



fixed metal



adjustable metal



adjustable AQUA DIN DUO



CAMBIO door, version 00, adjustable DIN DUO door frame



concealed DUO hinge black – standard for the system. non-rebated system BLACK MATT collection



concealed hinge DUO white – option for the non-rebated system

COLOR RANGE – pp. 303-310

PAINTED	MONO1 MAT	MONO2 MAT	MONO3 MAT
001 RAL white 9003	OMA RAL 9010 matt OMB RAL 9016 matt OME RAL 9001 matt OMF RAL 9002 matt OMS RAL 7047 grey matt OMG RAL 7035 matt OMH RAL 7004 matt OM6 NCS S 2005-Y50R beige matt OMD NCS S 1502-Y50R light beige matt OMC NCS S 1002-Y50R sand grey matt 000 NCS S 0500-N white OMI NCS S 0502-Y matt	OM7 NCS S 4010-G50Y sage matt OM4 RAL 5011 indigo matt OM1 RAL 5014 sky blue matt OMJ RAL 1015 matt OMK RAL 7044 matt OML RAL 7038 matt OND RAL 7037 matt OMM NCS S 0300-N matt OMN NCS S 1502-Y matt OMO NCS S 1000-N matt OMP NCS S 1002-Y matt OMQ NCS S 1500-N matt OMR NCS S 3005-Y50R matt OMS NCS S 4005-Y50R matt OMT NCS S 2005-R80B matt OMU NCS S 1502-R matt 002 RAL 9005 BLACK black	ON1 NCS S 8000-N matt ON2 RAL 7016 matt ON3 RAL 7024 matt ON4 NCS S 8500-N matt ON6 NCS S 7000-N matt ON7 NCS S 6005-Y50R matt ON8 RAL 1019 matt ON9 RAL 1013 matt ONA RAL 6003 matt ONB RAL 6013 matt ONC RAL 6012 matt



laminated edge of the door leaf in black, graphite or grey – option (does not apply to BLACK MATT surface)

INCLUDED IN THE PRICE OF THE DOOR	
Solid construction made of a wooden frame, filled with a layer of "honeycomb" structure. Three-layer painting system ensuring color durability for many years. The bottom edge of the door leaf is protected with a special impregnating agent against moisture.	
color black RAL 9005	
magnetic lock, lock faceplate and concealed black hinges	
glass white matt or transparent with a thickness of 4 mm	
tempered glass white matt with a thickness of 4 mm (version 03SD)	
REBATED SYSTEM	
visible hinge silver galvanized "60"- "80" - 2 pcs., "90" - 3 pcs.	
type K – for door frame DIN system, type C – for wooden door frame, type M – for metal door frame	
silver latch-bolt lock: for key, cylinder, bathroom lock, without keyhole	
NON-REBATED SYSTEM	
concealed hinge, satin nickel "60"- "80" - 2 pcs., "90" - 3 pcs.	
magnetic lock, satin chrome: for key, cylinder, bathroom lock, without keyhole	
FOR EXTRA CHARGE	
non-standard door sizes	p. 296
tempered and laminated glass	p. 303
stile and rail (enabling self-shortening up to 50 mm)	
stile and rail (enabling self-shortening up to 90 mm)	
perforated chipboard filling	
solid chipboard filling (3rd hinge recommended)	
door closers, electric strikes	pp. 281, 283
reinforcement for door closer	
drop seal	
heat recovery ventilation	without extra charge

ventilation undercut	
edge of the door leaf black, grey or graphite	without extra charge
sliding systems	pp. 168-177
REBATED SYSTEM	
additional visible hinge type M silver galvanized	
additional visible hinge type M black	
additional visible hinge type K, type C silver galvanized or black	
change of lock color to black	
in the case of a door leaf with a door closer and a DIN or metal door frame, type T hinges should be used in the following quantities: "60"- "80" - 3 pcs.; "90"- "110" - 4 pcs.; extra charge for additional hinge type T	
NON-REBATED SYSTEM	
additional concealed hinge satin nickel	
change of hinge color to white or black	
change of hinge color to gold	
change of magnetic lock color to white, black or gold	
non-rebated lock with latch (silver, white, black or gold) - NEW	
REVES SYSTEM (reverse rebate) - version 00	
additional concealed TE hinge, silver	
change of TE hinge color to white or black	
change of TE hinge color to gold	

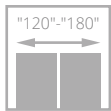
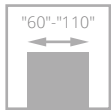

01 / VF1



02 / VF2



03 / VF3



07 / VF16

NEW VERSIONS



17 / VF17



18 / VF18



19 / VF19



20 / VF20



21 / VF21



22 / VF22



23 / VF23



24 / VF24

DOOR FRAMES



fixed POL-SKONE system



adjustable DIN system



fixed metal



adjustable metal



adjustable AQUA DIN



adjustable REVES system



fixed DUO



adjustable DIN DUO



adjustable VERTIGO

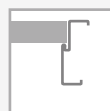

fixed metal



adjustable metal



adjustable AQUA DIN DUO



laminated edge of the door leaf in black, graphite or grey color – option (does not apply to BLACK MATT surface)

SUBITO door, version 07, adjustable DIN SYSTEM door frame

COLOR RANGE – pp. 303-310

PAINTED	MONO1 MAT	MONO2 MAT	MONO3 MAT
001 RAL white 9003	OMA RAL 9010 matt OMB RAL 9016 matt OME RAL 9001 matt OMF RAL 9002 matt OMS RAL 7047 grey matt OMG RAL 7035 matt OMH RAL 7004 matt OM6 NCS S 2005-Y50R beige matt OMD NCS S 1502-Y50R light beige matt OMC NCS S 1002-Y50R sand grey matt 000 NCS S 0500-N white OMI NCS S 0502-Y matt	OM7 NCS S 4010-G50Y sage matt OM4 RAL 5011 indigo matt OM1 RAL 5014 sky blue matt OMJ RAL 1015 matt OMK RAL 7044 matt OML RAL 7038 matt OND RAL 7037 matt OMM NCS S 0300-N matt OMN NCS S 1502-Y matt OMO NCS S 1000-N matt OMP NCS S 1002-Y matt OMQ NCS S 1500-N matt OMR NCS S 3005-Y50R matt OMS NCS S 4005-Y50R matt OMT NCS S 2005-R80B matt OMU NCS S 1502-R matt 002 RAL 9005 BLACK black	ON1 NCS S 8000-N matt ON2 RAL 7016 matt ON3 RAL 7024 matt ON4 NCS S 8500-N matt ON6 NCS S 7000-N matt ON7 NCS S 6005-Y50R matt ON8 RAL 1019 matt ON9 RAL 1013 matt ONA RAL 6003 matt ONB RAL 6013 matt ONC RAL 6012 matt

INCLUDED IN THE PRICE OF THE DOOR	
Solid construction made of a wooden frame, filled with a layer of "honeycomb" structure. Three-layer painting system ensuring color durability for many years. The bottom edge of the door leaf is protected with a special impregnating agent against moisture.	
millling width 6 mm	
version 07 – only symmetrical division in double-leaf door "60"+"60", "70"+"70", "80"+"80", "90"+"90"	
color black RAL 9005	
magnetic lock, lock faceplate and concealed black hinges	
REBATED SYSTEM	
visible hinge silver galvanized "60"- "80" - 2 pcs., "90" - 3 pcs.	
type K - for door frame DIN system, type C - for wooden door frame, type M - for metal door frame	
silver latch-bolt lock: for key, cylinder, bathroom lock, without keyhole	
NON-REBATED SYSTEM	
concealed hinge satin nickel "60"- "70" – 2 pcs., "80"- "90" – 3 pcs.	
magnetic lock, satin chrome: for key, cylinder, bathroom lock, without keyhole	
FOR EXTRA CHARGE	
non-standard door sizes	p. 296
stile and rail (enabling self-shortening up to 50 mm)	
stile and rail (enabling self-shortening up to 90 mm)	
perforated chipboard filling	
solid chipboard filling (third hinge recommended)	
door closers, electric strikes	pp. 281, 283
drop seal	
heat recovery ventilation	without extra charge

ventilation undercut	
edge of the door leaf in black, grey or graphite color	without extra charge
sliding systems	pp. 168-177
REBATED SYSTEM	
additional visible hinge type M silver galvanized	
additional visible hinge type M black	
additional visible hinge type T silver (DIN or metal door frame)	
additional visible hinge type T black or gold (DIN or metal door frame)	
change of hinge color type T to black or gold (DIN door frame)	
change of hinge color type T to black (metal door frame)	
additional visible hinge type C galvanized silver or black	
change of lock color to black	
In the case of a door leaf with a door closer and a DIN or metal door frame, T-type hinges should be used in the following quantities: "60"- "80" – 3 pcs., "90"- "110" – 4 pcs., extra charge for an additional T-type hinge.	
NON-REBATED SYSTEM	
additional concealed hinge satin nickel	
change of hinge color to white or black	
change of hinge color to gold	
change of magnetic lock color to white, black or gold	
non-rebated lock with latch (silver, white, black or gold) - NEW	
REVES SYSTEM (reverse rebate)	
additional concealed TE hinge, silver	
change of TE hinge color to white or black	
change of TE hinge color to gold	

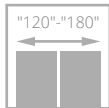
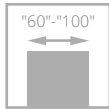

WHITE MATT TEMPERED GLASS



A01 / V1SA



A02 / V2SA



B1 / VF11



B2 / VF12



B3 / VF13

BLACK LAMINATED GLASS



A01 / V1SA black glass



A02 / V2SA black glass

WHITE MATT LAMINATED GLASS



A01 / V1SA white glass



A02 / V2SA white glass

DOOR FRAMES



fixed POL-SKONE system



adjustable DIN system



fixed metal



adjustable metal



adjustable AQUA DIN



adjustable REVES system



fixed DUO



adjustable DIN DUO

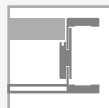

adjustable VERTIGO



fixed metal



adjustable metal



adjustable AQUA DIN DUO



ESTATO door, version A01, adjustable DIN SYSTEM door frame



milling on the surface of the door leaf



laminated glass in white matt color

COLOR RANGE – pp. 303-310

PAINTED

MONO1 MAT

001 RAL white 9003

- OMA** RAL 9010 matt
- OMB** RAL 9016 matt
- OME** RAL 9001 matt
- OMF** RAL 9002 matt
- OMS** RAL 7047 grey matt
- OMG** RAL 7035 matt
- OMH** RAL 7004 matt
- OM6** NCS S 2005-Y50R beige matt
- OMD** NCS S 1502-Y50R light beige matt
- OMC** NCS S 1002-Y50R sand grey matt
- 000** NCS S 0500-N white
- OMI** NCS S 0502-Y matt



laminated edge of the door leaf in black, graphite or grey color – option (does not apply to BLACK MATT surface)

INCLUDED IN THE PRICE OF THE DOOR

The structure of the door leaf consists of a wooden stile and rail, filled with a perforated board. Three-layer painting system ensuring color durability for many years. The bottom edge of the door leaf is protected with a special impregnating agent against moisture.

laminated safety glass VSG 44.2 in white matt or black color, thickness 8.5 mm (glazing width version A01-58 mm, A02-208 mm)*

tempered glass white matt, thickness 6 mm (version A01-58 mm, A02-208 mm)*

REBATED SYSTEM

visible hinge silver galvanized "60"- "80" - 2 pcs., "90" - 3 pcs.
type T – for DIN system and metal door frame,
type C silver – for wooden door frame
silver latch-bolt lock: for key, cylinder, bathroom lock, without keyhole

NON-REBATED SYSTEM

concealed satin nickel hinge "60"- "70" - 2 pcs., "80"- "90" - 3 pcs.
magnetic lock, satin chrome: for key, cylinder, bathroom lock, without

FOR EXTRA CHARGE

non-standard door sizes p. 296

tempered glass Linea black VSG/ESG 44.4 with double-sided ornament (below 10 pcs.)

tempered glass Linea black VSG/ESG 44.4 with double-sided ornament (above 10 pcs.)

stile and rail (enabling self-shortening up to 50 mm) – does not apply to version A01, A02

stile and rail (enabling self-shortening up to 90 mm) – does not apply to version A01, A02

solid chipboard filling (third hinge recommended)

door closers, electric strikes pp. 281, 283

drop seal (applies to versions B1, B2, B3)

heat recovery ventilation without extra charge

ventilation undercut – applies to versions B1, B2, B3 (pp. 286-287)

ventilation undercut in version A01 in widths "60"- "100" (pp. 286-287)

* dimension tolerance +/- 2 mm



glass in black color – option

ventilation undercut in version A02 in widths "70"- "100" (pp. 286-287)

sliding systems (not applicable to version A01) pp. 168-177

edge of the door leaf in black color (not applicable to REVES without extra charge)

REBATED SYSTEM

additional visible hinge type T silver

additional visible hinge type T black

change of hinge color type T to black or gold

additional visible hinge type C silver or black

change of lock color to black

NON-REBATED SYSTEM

additional concealed hinge satin nickel

change of hinge color to white or black

change of hinge color to gold

change of magnetic lock color to white, black or gold

non-rebated lock with latch (silver, white, black or gold) - **NEW**

REVES SYSTEM (reverse rebate)

additional concealed TE hinge, silver

change of TE hinge color to white or black

change of TE hinge color to gold

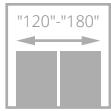
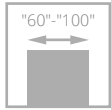

W01 / VD1



W02 / VD2



W07 / VD7



W03 / VD3



W04 / VD4



W06 / VD6



W08 / VD8

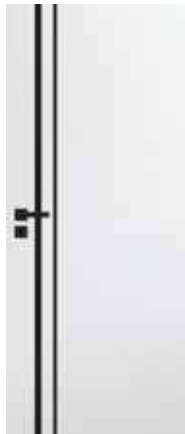

W09 / VD9

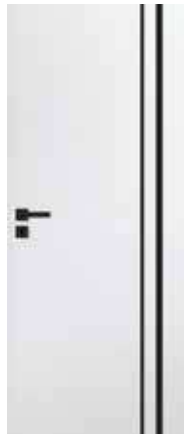

W10 / VD10



W11 / VD11

LINTEL PANEL (p. 249)



DOOR FRAMES



fixed POL-SKONE system



adjustable DIN system



fixed metal



adjustable metal



adjustable AQUA DIN



adjustable REVES system



fixed DUO



adjustable DIN DUO

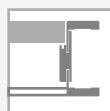

adjustable VERTIGO



fixed metal



adjustable metal



adjustable AQUA DIN DUO



hidden door TIARA, version W09, adjustable DIN SYSTEM door frame



aluminum decors on the surface of the door leaf in chrome matt color (standard)



concealed hinge DUO white – option for the system. non-rebated system

COLOR RANGE – pp. 303-310

PAINTED	MONO1 MAT	MONO2 MAT	MONO3 MAT
001 RAL white 9003	OMA RAL 9010 matt OMB RAL 9016 matt OME RAL 9001 matt OMF RAL 9002 matt OMS RAL 7047 grey matt OMG RAL 7035 matt OMH RAL 7004 matt OM6 NCS S 2005-Y50R beige matt OMD NCS S 1502-Y50R light beige matt OMC NCS S 1002-Y50R sand grey matt 000 NCS S 0500-N white OMI NCS S 0502-Y matt	OM7 NCS S 4010-G50Y sage matt OM4 RAL 5011 indigo matt OM1 RAL 5014 sky blue matt OMJ RAL 1015 matt OMK RAL 7044 matt OML RAL 7038 matt OND RAL 7037 matt OMM NCS S 0300-N matt OMN NCS S 1502-Y matt OMO NCS S 1000-N matt OMP NCS S 1002-Y matt OMQ NCS S 1500-N matt OMR NCS S 3005-Y50R matt OMS NCS S 4005-Y50R matt OMT NCS S 2005-R80B matt OMU NCS S 1502-R matt 002 RAL 9005 BLACK black	ON1 NCS S 8000-N matt ON2 RAL 7016 matt ON3 RAL 7024 matt ON4 NCS S 8500-N matt ON6 NCS S 7000-N matt ON7 NCS S 6005-Y50R matt ON8 RAL 1019 matt ON9 RAL 1013 matt ONA RAL 6003 matt ONB RAL 6013 matt ONC RAL 6012 matt

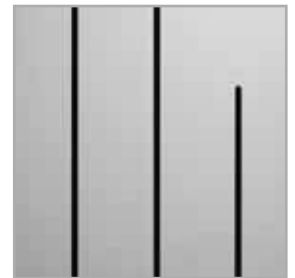

aluminum decors on the surface of the door leaf in chrome gloss color (not applicable to versions W03, W04, W06), black, gold gloss



concealed DUO hinge black – standard for the system. non-rebated collection BLACK MATT

INCLUDED IN THE PRICE OF THE DOOR

The structure of the door leaf consists of a wooden stile and rail, filled with a perforated board. Three-layer painting system ensuring color durability for many years. The bottom edge of the door leaf is protected with a special impregnating agent against moisture.

aluminum decors with a width of 25 mm and 10 mm in matt chrome, matt black, matt copper, matt gold color - applies to version W09, W10, W11

aluminum decors with a width of 7.2 mm in matt chrome, matt black, chrome gloss, gold gloss color - applies to versions W01-W08 (chrome gloss color - not applicable to versions W03, W04, W06)

no possibility to use a ventilation gap or ventilation grille - version W08, W09, W10, W11

color black RAL 9005

magnetic lock, lock faceplate and concealed black hinges

REBATED SYSTEM

visible silver galvanized hinge "60"- "70" - 2 pcs., "80"- "90" - 3 pcs.

type K - for door frame DIN system, type C - for wooden door frame, type M - for metal door frame

silver latch-bolt lock: for key, cylinder, bathroom lock, without keyhole

NON-REBATED SYSTEM

concealed satin nickel hinge "60"- "70" - 2 pcs., "80"- "90" - 3 pcs.

magnetic lock, satin chrome: for key, cylinder, bathroom lock, without keyhole

FOR EXTRA CHARGE

non-standard door sizes p. 296

stile and rail (allowing self-shortening up to 50 mm) - not applicable to versions W08, W09, W10, W11

stile and rail (allowing self-shortening up to 90 mm) - not applicable to versions W08, W09, W10, W11

solid chipboard filling (third hinge recommended)

door closers, electric strikes pp. 281, 283

drop seal not possible

heat recovery ventilation	without extra charge
ventilation undercut (pp. 286-287)	
sliding systems (not applicable to version A01)	pp. 168-177
edge of the door leaf in black, gray or graphite color	without extra charge

REBATED SYSTEM

additional visible hinge type M silver galvanized

additional visible hinge type M black

additional visible hinge type K, type C galvanized silver or black

change of lock color to black

additional visible hinge type C silver or black

change of lock color to black

NON-REBATED SYSTEM

additional concealed hinge satin nickel

change of hinge color to white or black

change of hinge color to gold

change of magnetic lock color to white, black or gold

non-rebated lock with latch (silver, white, black or gold) - **NEW**

REVES SYSTEM (reverse rebate)

additional concealed TE hinge, silver

change of TE hinge color to white or black

change of TE hinge color to gold

* dimension tolerance +/- 2 mm

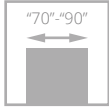

V0

DOOR FRAMES



fixed POL-SKONE system



adjustable DIN system



fixed metal



adjustable metal



adjustable AQUA DIN



adjustable REVES system



fixed DUO



adjustable DIN DUO



adjustable VERTIGO



fixed metal



adjustable metal



adjustable AQUA DIN DUO



door leaf profile

hidden door SENTO, version V0, adjustable DIN DUO SYSTEM door frame

COLOR RANGE – pp. 303-310

PAINTED	MONO1 MAT	MONO2 MAT	MONO3 MAT
001 RAL white 9003	OMA RAL 9010 matt OMB RAL 9016 matt OME RAL 9001 matt OMF RAL 9002 matt OMS RAL 7047 grey matt OMG RAL 7035 matt OMH RAL 7004 matt OM6 NCS S 2005-Y50R beige matt OMD NCS S 1502-Y50R light beige matt OMC NCS S 1002-Y50R sand grey matt OOO NCS S 0500-N white OMI NCS S 0502-Y matt	OM7 NCS S 4010-G50Y sage matt OM4 RAL 5011 indigo matt OM1 RAL 5014 sky blue matt OMJ RAL 1015 matt OMK RAL 7044 matt OML RAL 7038 matt OND RAL 7037 matt OMM NCS S 0300-N matt OMN NCS S 1502-Y matt OMO NCS S 1000-N matt OMP NCS S 1002-Y matt OMQ NCS S 1500-N matt OMR NCS S 3005-Y50R matt OMS NCS S 4005-Y50R matt OMT NCS S 2005-R80B matt OMU NCS S 1502-R matt 002 RAL 9005 BLACK black	ON1 NCS S 8000-N matt ON2 RAL 7016 matt ON3 RAL 7024 matt ON4 NCS S 8500-N matt ON6 NCS S 7000-N matt ON7 NCS S 6005-Y50R matt ON8 RAL 1019 matt ON9 RAL 1013 matt ONA RAL 6003 matt ONB RAL 6013 matt ONC RAL 6012 matt

INCLUDED IN THE PRICE OF THE DOOR	
Solid construction with a wooden frame, filled with a perforated board. Three-layer painting system ensuring color durability for many years. The bottom edge of the door leaf is protected with a special impregnating agent against moisture.	
color black RAL 9005	
magnetic lock, lock faceplate and concealed black hinges	
REBATED SYSTEM	
visible silver galvanized hinge "70"- "80" - 2 pcs., "90" - 3 pcs.	
type K - for door frame DIN system, type C - for wooden door frame, type M - for metal door frame	
silver latch-bolt lock: for key, cylinder, bathroom lock, without keyhole	
NON-REBATED SYSTEM	
concealed satin nickel hinge "70"- "80" - 2 pcs., "90" - 3 pcs.	
magnetic lock, satin chrome: for key, cylinder, bathroom lock, without keyhole	
FOR EXTRA CHARGE	
non-standard door sizes	p. 296
solid chipboard filling (third hinge recommended)	
door closers, electric strikes	pp. 281, 283
reinforcement for door closer	
drop seal	
heat recovery ventilation	without extra charge
ventilation undercut	
sliding systems	pp. 168-177

REBATED SYSTEM
additional visible hinge type M silver galvanized
additional visible hinge type M black
additional visible hinge type K, type C galvanized silver or black
change of lock color to black
in the case of a door leaf with a door closer and a DIN or metal door frame, type T hinges should be used in the following quantities: "60"- "80" - 3 pcs.; "90"- "110" - 4 pcs.; extra charge for additional hinge type T
NON-REBATED SYSTEM
additional concealed hinge satin nickel
change of hinge color to white or black
change of hinge color to gold
change of magnetic lock color to white, black or gold
non-rebated lock with latch (silver, white, black or gold) - NEW
REVES SYSTEM (reverse rebate) - only standard height
additional concealed TE hinge, silver
change of TE hinge color to white or black
change of TE hinge color to gold

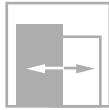
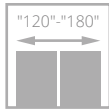
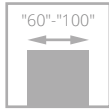

A0 / V00



A3 / VF3



B9 / VF7



B12 / VF8

DOOR HIGHER
A3 / VF3

VENTILATION OPTIONS
B12 / VF8

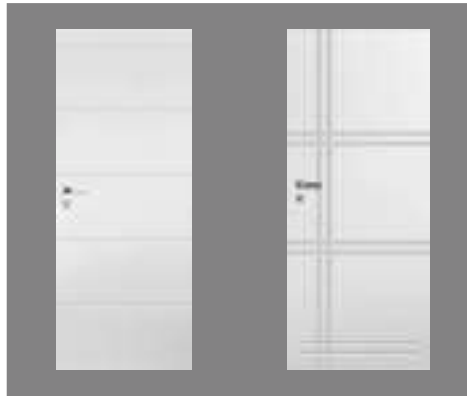

higher by 100 mm

gap

DOOR FRAMES



fixed POL-SKONE system



adjustable DIN system



fixed metal



adjustable metal



adjustable AQUA DIN



adjustable REVES system



fixed DUO



adjustable DIN DUO



adjustable VERTIGO



fixed metal



adjustable metal



adjustable AQUA DIN DUO



door SUBLIME, version B12, adjustable DIN SYSTEM door frame

COLOR RANGE – pp. 303-310

PAINTED	MONO1 MAT	MONO2 MAT	MONO3 MAT
001 RAL white 9003	OMA RAL 9010 matt OMB RAL 9016 matt OME RAL 9001 matt OMF RAL 9002 matt OMS RAL 7047 grey matt OMG RAL 7035 matt OMH RAL 7004 matt OM6 NCS S 2005-Y50R beige matt OMD NCS S 1502-Y50R light beige matt OMC NCS S 1002-Y50R sand grey matt 000 NCS S 0500-N white OMI NCS S 0502-Y matt	OM7 NCS S 4010-G50Y sage matt OM4 RAL 5011 indigo matt OM1 RAL 5014 sky blue matt OMJ RAL 1015 matt OMK RAL 7044 matt OML RAL 7038 matt OND RAL 7037 matt OMM NCS S 0300-N matt OMN NCS S 1502-Y matt OMO NCS S 1000-N matt OMP NCS S 1002-Y matt OMQ NCS S 1500-N matt OMR NCS S 3005-Y50R matt OMS NCS S 4005-Y50R matt OMT NCS S 2005-R80B matt OMU NCS S 1502-R matt 002 RAL 9005 BLACK black	ON1 NCS S 8000-N matt ON2 RAL 7016 matt ON3 RAL 7024 matt ON4 NCS S 8500-N matt ON6 NCS S 7000-N matt ON7 NCS S 6005-Y50R matt ON8 RAL 1019 matt ON9 RAL 1013 matt ONA RAL 6003 matt ONB RAL 6013 matt ONC RAL 6012 matt



milling on the surface of the door leaf, width 30 mm in version B9



milling on the surface of the door leaf, width 15 mm in version B12



milling on the surface of the door leaf, width 6 mm in version A3



laminated edge of the door leaf in black, graphite or grey color – option (does not apply to BLACK MATT surface)

INCLUDED IN THE PRICE OF THE DOOR	
Solid construction with a wooden frame, filled with a perforated board. Three-layer painting system ensuring color durability for many years. The bottom edge of the door leaf is protected with a special impregnating agent against moisture.	
milling width version B9 - 30 mm, version B12 - 15 mm, version A3 - 6 mm	
color black RAL 9005	
magnetic lock, lock faceplate and concealed black hinges	
REBATED SYSTEM	
visible hinge silver galvanized "60"- "80" - 2 pcs., "90" - 3 pcs. type T – for door frame DIN system and metal, type C – for wooden door frame silver latch-bolt lock: for key, cylinder, bathroom lock, without keyhole	
NON-REBATED SYSTEM	
concealed hinge satin nickel "60"- "70" – 2 pcs., "80"- "90" – 3 pcs. magnetic lock, satin chrome: for key, cylinder, bathroom lock, without	
FOR EXTRA CHARGE	
non-standard door sizes	p. 296
stile and rail (enabling self-shortening up to 50 mm)	
stile and rail (enabling self-shortening up to 90 mm)	
solid chipboard filling (third hinge recommended)	
door closers, electric strikes	pp. 281, 283
drop seal	
heat recovery ventilation	without extra charge

ventilation undercut	
edge of the door leaf black, grey or graphite	without extra charge
sliding systems	pp. 168-177
REBATED SYSTEM	
additional visible silver hinge type T	
additional visible black or gold hinge type T	
change of hinge color type T to black or gold (DIN door frame)	
change of hinge color type T to black (metal door frame)	
additional visible silver galvanized or black hinge, type C	
change of lock color to black	
NON-REBATED SYSTEM	
additional concealed hinge satin nickel	
change of hinge color to white or black	
change of hinge color to gold	
change of magnetic lock color to white, black or gold	
non-rebated lock with latch (silver, white, black or gold) - NEW	
REVES SYSTEM (reverse rebate)	
additional concealed TE hinge, silver	
change of TE hinge color to white or black	
change of TE hinge color to gold	

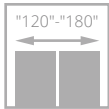
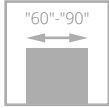

00 / V03



01 / V3S1



03 / V3S3



04 / V3SD

DOOR FRAMES



fixed POL-SKONE system



adjustable DIN system



fixed metal



adjustable metal



adjustable AQUA DIN



adjustable REVES system



fixed DUO



adjustable DIN DUO



adjustable VERTIGO

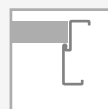

fixed metal



adjustable metal



adjustable AQUA DIN DUO



FIORD door, version 00, adjustable door frame



glazing, frame



concealed hinge DUO white – option for the system. non-rebated system

COLOR RANGE – pp. 303-310

PAINTED	MONO1 MAT	MONO2 MAT	MONO3 MAT
001 RAL white 9003	OMA RAL 9010 matt OMB RAL 9016 matt OME RAL 9001 matt OMF RAL 9002 matt OMS RAL 7047 grey matt OMG RAL 7035 matt OMH RAL 7004 matt OM6 NCS S 2005-Y50R beige matt OMD NCS S 1502-Y50R light beige matt OMC NCS S 1002-Y50R sand grey matt 000 NCS S 0500-N white OMI NCS S 0502-Y matt	OM7 NCS S 4010-G50Y sage matt OM4 RAL 5011 indigo matt OM1 RAL 5014 sky blue matt OMJ RAL 1015 matt OMK RAL 7044 matt OML RAL 7038 matt OND RAL 7037 matt OMM NCS S 0300-N matt OMN NCS S 1502-Y matt OMO NCS S 1000-N matt OMP NCS S 1002-Y matt OMQ NCS S 1500-N matt OMR NCS S 3005-Y50R matt OMS NCS S 4005-Y50R matt OMT NCS S 2005-R80B matt OMU NCS S 1502-R matt 002 RAL 9005 BLACK black	ON1 NCS S 8000-N matt ON2 RAL 7016 matt ON3 RAL 7024 matt ON4 NCS S 8500-N matt ON6 NCS S 7000-N matt ON7 NCS S 6005-Y50R matt ON8 RAL 1019 matt ON9 RAL 1013 matt ONA RAL 6003 matt ONB RAL 6013 matt ONC RAL 6012 matt



door leaf profile

INCLUDED IN THE PRICE OF THE DOOR	
Solid construction made of a wooden frame, filled with a layer of "honeycomb" structure. Three-layer painting system ensuring color durability for many years. The bottom edge of the door leaf is protected with a special impregnating agent against moisture.	
color black RAL 9005	
magnetic lock, lock faceplate and concealed black hinges	
white matt or transparent glass with a thickness of 4 mm	
REBATED SYSTEM	
visible hinge silver galvanized "60"- "80" - 2 pcs., "90" - 3 pcs.	
type K - for door frame DIN system, type C - for wooden door frame, type M - for metal door frame	
silver latch-bolt lock: for key, cylinder, bathroom lock, without keyhole	
NON-REBATED SYSTEM	
concealed hinge, satin nickel "60"- "80" - 2 pcs., "90" - 3 pcs.	
magnetic lock, satin chrome: for key, cylinder, bathroom lock, without keyhole	
FOR EXTRA CHARGE	
non-standard door sizes	p. 296
tempered and laminated glass	p. 302
tempered transparent glass with a thickness of 4 mm extra charge	
stile and rail (enabling self-shortening up to 50 mm)	
solid chipboard filling (third hinge recommended)	
door closers, electric strikes	pp. 281, 283
reinforcement for door closer	
drop seal	

heat recovery ventilation	without extra charge
ventilation undercut	
edge of the door leaf in black, grey or graphite color	without extra charge
sliding systems	pp. 168-177
REBATED SYSTEM	
additional visible hinge type M silver galvanized	
additional visible hinge type M black	
additional visible hinge type K, type C silver galvanized or black	
change of lock color to black	
in the case of a door leaf with a door closer and a DIN or metal door frame, type T hinges should be used in the following quantities: "60"- "80" - 3 pcs.; "90"- "110" - 4 pcs.; extra charge for additional hinge type T	
NON-REBATED SYSTEM	
additional concealed hinge satin nickel	
change of hinge color to white or black	
change of hinge color to gold	
change of magnetic lock color to white, black or gold	
non-rebated lock with latch (silver, white, black or gold) - NEW	
REVES SYSTEM (reverse rebate)	
additional concealed TE hinge, silver	
change of TE hinge color to white or black	
change of TE hinge color to gold	

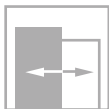
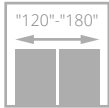
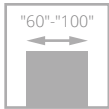

V01



V02



V03



V04



V05

DOOR FRAMES



fixed POL-SKONE system



adjustable DIN system



fixed metal



adjustable metal



adjustable AQUA DIN



adjustable REVES system



fixed DUO



adjustable DIN DUO



adjustable VERTIGO

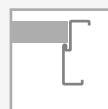

fixed metal



adjustable metal



adjustable AQUA DIN DUO



ROYALE door, version V05, adjustable DIN door frame



frame profile

COLOR RANGE – pp. 303-310

PAINTED	MONO1 MAT	MONO2 MAT	MONO3 MAT
001 RAL white 9003	OMA RAL 9010 matt OMB RAL 9016 matt OME RAL 9001 matt OMF RAL 9002 matt OMS RAL 7047 grey matt OMG RAL 7035 matt OMH RAL 7004 matt OMG NCS S 2005-Y50R beige matt OMD NCS S 1502-Y50R light beige matt OMC NCS S 1002-Y50R sand grey matt 000 NCS S 0500-N white OMI NCS S 0502-Y matt	OM7 NCS S 4010-G50Y sage matt OM4 RAL 5011 indigo matt OM1 RAL 5014 sky blue matt OMJ RAL 1015 matt OMK RAL 7044 matt OML RAL 7038 matt OND RAL 7037 matt OMM NCS S 0300-N matt OMN NCS S 1502-Y matt OMO NCS S 1000-N matt OMP NCS S 1002-Y matt OMQ NCS S 1500-N matt OMR NCS S 3005-Y50R matt OMS NCS S 4005-Y50R matt OMT NCS S 2005-R80B matt OMU NCS S 1502-R matt 002 RAL 9005 BLACK black	ON1 NCS S 8000-N matt ON2 RAL 7016 matt ON3 RAL 7024 matt ON4 NCS S 8500-N matt ON6 NCS S 7000-N matt ON7 NCS S 6005-Y50R matt ON8 RAL 1019 matt ON9 RAL 1013 matt ONA RAL 6003 matt ONB RAL 6013 matt ONC RAL 6012 matt

INCLUDED IN THE PRICE OF THE DOOR
Solid construction with a wooden frame, filled with a perforated board. Profiled decorative frame on the surface of the door leaf. Three-layer painting system ensuring color durability for many years. The bottom edge of the door leaf is protected with a special impregnating agent against moisture.
color black RAL 9005 magnetic lock, lock faceplate and concealed black hinges
REBATED SYSTEM visible hinge silver galvanized "60"- "80" - 2 pcs., "90" - 3 pcs. type K – for door frame DIN system, type C – for wooden door frame, type M – for metal door frame silver latch-bolt lock: for key, cylinder, bathroom lock, without keyhole
NON-REBATED SYSTEM concealed hinge, satin nickel "60"- "80" - 2 pcs., "90" - 3 pcs. magnetic lock, satin chrome: for key, cylinder, bathroom lock, without keyhole

FOR EXTRA CHARGE	
non-standard door sizes	p. 296
door closers, electric strikes	pp. 281, 283
drop seal	
heat recovery ventilation	without extra charge
ventilation undercut	
edge of the door leaf black, grey or graphite	without extra charge
sliding systems	pp. 168-177
REBATED SYSTEM	
additional visible hinge type M silver galvanized	
additional visible hinge type M black	
additional visible hinge type K, type C silver galvanized or black	
change of lock color to black	
NON-REBATED SYSTEM	
additional concealed hinge satin nickel	
change of hinge color to white or black	
change of hinge color to gold	
change of magnetic lock color to white, black or gold	
non-rebated lock with latch (silver, white, black or gold) - NEW	
REVES SYSTEM (reverse rebate) above the ZW4 range, the door opening angle is 80°	
additional concealed TE hinge, silver	
change of TE hinge color to white or black	
change of TE hinge color to gold	

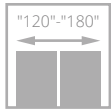
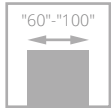

V01



V02

DOOR FRAMES



fixed POL-SKONE system



adjustable DIN system



fixed metal



adjustable metal



adjustable AQUA DIN



adjustable REVES system



fixed DUO



adjustable DIN DUO

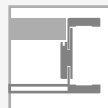

adjustable VERTIGO

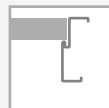

fixed metal



adjustable metal



adjustable AQUA DIN DUO



decorative grooving

RIFLO door, version V01, adjustable DIN door frame

COLOR RANGE – pp. 303-310

PAINTED	MONO1 MAT	MONO2 MAT	MONO3 MAT
001 RAL white 9003	OMA RAL 9010 matt OMB RAL 9016 matt OME RAL 9001 matt OMF RAL 9002 matt OMS RAL 7047 grey matt OMG RAL 7035 matt OMH RAL 7004 matt OM6 NCS S 2005-Y50R beige matt OMD NCS S 1502-Y50R light beige matt OMC NCS S 1002-Y50R sand grey matt 000 NCS S 0500-N white OMI NCS S 0502-Y matt	OM7 NCS S 4010-G50Y sage matt OM4 RAL 5011 indigo matt OM1 RAL 5014 sky blue matt OMJ RAL 1015 matt OMK RAL 7044 matt OML RAL 7038 matt OND RAL 7037 matt OMM NCS S 0300-N matt OMN NCS s 1502-Y matt OMO NCS S 1000-N matt OMP NCS S 1002-Y matt OMQ NCS S 1500-N matt OMR NCS S 3005-Y50R matt OMS NCS S 4005-Y50R matt OMT NCS S 2005-R80B matt OMU NCS S 1502-R matt 002 RAL 9005 BLACK black	ON1 NCS S 8000-N matt ON2 RAL 7016 matt ON3 RAL 7024 matt ON4 NCS S 8500-N matt ON6 NCS S 7000-N matt ON7 NCS S 6005-Y50R matt ON8 RAL 1019 matt ON9 RAL 1013 matt ONA RAL 6003 matt ONB RAL 6013 matt ONC RAL 6012 matt

INCLUDED IN THE PRICE OF THE DOOR
Solid construction made of a wooden stile and rail. Decorative grooving on the surface of the door leaf and a decorative frame with a width of 30 mm. Three-layer painting system ensuring color durability for many years. The bottom edge of the door leaf is protected with a special impregnating agent against moisture.
color black RAL 9005
magnetic lock, lock faceplate and concealed black hinges
REBATED SYSTEM
visible hinge silver galvanized "60"- "80" - 2 pcs., "90" - 3 pcs. type K – for door frame DIN system, type C – for wooden door frame, type M – for metal door frame silver latch-bolt lock: for key, cylinder, bathroom lock, without keyhole
NON-REBATED SYSTEM
concealed hinge, satin nickel "60"- "80" - 2 pcs., "90" - 3 pcs. magnetic lock, satin chrome: for key, cylinder, bathroom lock, without keyhole

FOR EXTRA CHARGE	
non-standard door sizes	p. 296
door closers, electric strikes	pp. 281, 283
drop seal	
heat recovery ventilation	without extra charge
ventilation undercut	
edge of the door leaf black, grey or graphite	without extra charge
sliding systems	pp. 168-177
REBATED SYSTEM	
additional visible hinge type M silver galvanized	
additional visible hinge type M black	
additional visible hinge type K, type C silver galvanized or black	
change of lock color to black	
NON-REBATED SYSTEM	
additional concealed hinge satin nickel	
change of hinge color to white or black	
change of hinge color to gold	
change of magnetic lock color to white, black or gold	
non-rebated lock with latch (silver, white, black or gold) - NEW	
REVES SYSTEM (reverse rebate) above the ZW3 range, the door opening angle is 80°	
additional concealed TE hinge, silver	
change of TE hinge color to white or black	
change of TE hinge color to gold	

Due to the decorative frame on the door leaf, the maximum opening angle of the door in the HARMONY ODW system from a wall thickness of 115 mm is 80°.

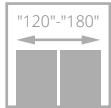
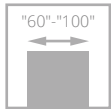

for door leaves with ventilation option



W00 / V01



W01 / V1SD



V1SP



WLZ | WLA/Z



W05 VERSE / V6SD

mirror*

* WLZ - mirror on the hinge side
WLA/Z - mirror on the side opposite to the hinge

MORE VERSIONS
ON THE NEXT
PAGE



DOOR FRAMES



fixed POL-SKONE system



adjustable DIN system



adjustable DIN SOLID



fixed metal



adjustable metal



adjustable AQUA DIN



fixed DUO



adjustable DIN DUO



adjustable DIN DUO SOLID



adjustable VERTIGO



fixed metal



adjustable metal



adjustable AQUA DIN DUO



SEMPRE LUX door, version W05 VERSE, adjustable DIN SOLID door frame



grain of the stile and rail





















horizontal grain of the panels



panel with finished edge glued to the glass - version V1SP

COLOR RANGE - pp. 303-310

VENEERED GROUP A	 312 limba	 334 European oak				
VENEERED GROUP B	 340 ebony	 404 dark walnut	 405 light walnut	 421 cappuccino	 422 mocha	 424 teak
VENEERED GROUP C	 370 whitewashed oak					
VENEERED GROUP D	 313 classic oak	 460 makassar	 NEW 461 caramel oak	 NEW 462 truffle oak	 NEW 463 chocolate oak	
VENEERED REALWOOD	 470 nabucco matt	 471 tosca matt	 472 traviata matt	 473 kastano matt		

INCLUDED IN THE PRICE OF THE DOOR

Solid construction made of a wooden stile and rail. The surface is covered with natural veneers, protected by an ecological UV lacquer ensuring color durability and scratch resistance. Vertical elements - vertical grain, horizontal elements - horizontal grain.

white matt glass, brown matt glass, graphite matt glass or transparent glass with a thickness of 4 mm

tempered glass white matt with a thickness of 4 mm - version W01, V1SP

tempered glass white matt with a thickness of 6 mm - version W05 VERSE

panel with a thickness of 12 mm - version W00

HDF panel in the color of the door leaf with a thickness of 3.5 mm (double-sided), edges protected - version V1SP

single-sided mirror - version WLZ, WLAZ

REBATED SYSTEM

visible hinge, brushed nickel "60"- "80" - 2 pcs., "90" - 3 pcs.

type K - for door frame DIN system, type C - for wooden door frame,

type M silver - for metal door frame

silver latch-bolt lock: for key, cylinder, bathroom lock, without keyhole

NON-REBATED SYSTEM

concealed hinge, satin nickel "60"- "80" - 2 pcs., "90" - 3 pcs.

magnetic lock, satin chrome: for key, cylinder, bathroom lock, without keyhole

FOR EXTRA CHARGE

non-standard door sizes p. 296

tempered transparent glass with a thickness of 4 mm

tempered Antisol grey glass (version V1SP)

tempered Antisol dark grey, brown glass (version V1SP)

laminated glass VSG 22.1 black color (version W02)

laminated glass VSG 22.1 black color (version W03)

door closers, electric strikes pp. 281, 283

drop seal

heat recovery ventilation without extra charge

ventilation undercut (pp. 286-287)

sliding systems pp. 168-177

REBATED SYSTEM

additional visible hinge type M silver

additional visible hinge type M black

additional visible hinge type K, type C brushed nickel or black

change of lock color to black

NON-REBATED SYSTEM

additional concealed hinge satin nickel

change of hinge color to white or black

change of hinge color to gold

change of magnetic lock color to white, black or gold

non-rebated lock with latch (silver, white, black or gold) - NEW

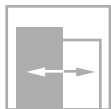
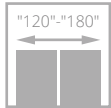
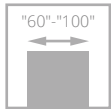

for door leaves with ventilation option



W02P / V02



W02 / V2S5



W02S2 / V2S2



W02S3 / V2S3



W02S4 / V2S4



W03P / V03



W03 / V3S5



W03S2 / V3S2



W03S3 / V3S3



W03S4 / V3S4

**MORE VERSIONS
ON THE PREVIOUS
PAGE**

DOOR FRAMES



fixed POL-SKONE system



adjustable DIN system



adjustable DIN SOLID



fixed metal



adjustable metal



adjustable AQUA DIN



fixed DUO



adjustable DIN DUO



adjustable DIN DUO SOLID



adjustable VERTIGO



fixed metal



adjustable metal



adjustable AQUA DIN DUO



SEMPRE LUX door, version W03P, adjustable DIN SOLID door frame





















grain of the stile and rail



horizontal grain of the panels

COLOR RANGE - pp. 303-310

VENEERED GROUP A	 312 limba	 334 European oak				
	VENEERED GROUP B					
	 340 ebony	 404 dark walnut	 405 light walnut	 421 cappuccino	 422 mocha	 424 teak
VENEERED GROUP C	 370 whitewashed oak					
VENEERED GROUP D	 313 classic oak	 460 makassar	 NEW 461 caramel oak	 NEW 462 truffle oak	 NEW 463 chocolate oak	
	VENEERED REALWOOD					
	 470 nabucco matt	 471 toska matt	 472 traviata matt	 473 kastano matt		



panel with finished edge glued to the glass - version V1SP

INCLUDED IN THE PRICE OF THE DOOR

Solid construction made of a wooden stile and rail. The surface is covered with natural veneers, protected by an ecological UV lacquer ensuring color durability and scratch resistance. Vertical elements - vertical grain, horizontal elements - horizontal grain.
white matt glass, brown matt glass, graphite matt glass or transparent glass with a thickness of 4 mm
HDF panel in the color of the door leaf with a thickness of 3.5 mm (double-sided), edges protected - version V1SP
single-sided mirror - version WLZ, WLA/Z

REBATED SYSTEM

visible hinge, brushed nickel "60"- "80" - 2 pcs., "90" - 3 pcs.
type K - for door frame DIN system, type C - for wooden door frame, silver M silver - for metal door frame
silver latch-bolt lock: for key, cylinder, bathroom lock, without keyhole

NON-REBATED SYSTEM

concealed hinge, satin nickel "60"- "80" - 2 pcs., "90" - 3 pcs.
magnetic lock, satin chrome: for key, cylinder, bathroom lock, without keyhole

FOR EXTRA CHARGE

non-standard door sizes p. 296
tempered transparent glass with a thickness of 4 mm
tempered Antisol grey glass (version V1SP)
tempered Antisol dark grey, brown glass (version V1SP)
laminated glass VSG 22.1 black color (version W02)
laminated glass VSG 22.1 black color (version W03)
door closers, electric strikes pp. 281, 283
drop seal
heat recovery ventilation without extra charge
ventilation undercut (pp. 286-287)
sliding systems pp. 168-177

REBATED SYSTEM

additional visible hinge type M silver
additional visible hinge type M black
additional visible hinge type K, type C brushed nickel or black
change of lock color to black

NON-REBATED SYSTEM

additional concealed hinge satin nickel
change of hinge color to white or black
change of hinge color to gold
change of magnetic lock color to white, black or gold
non-rebated lock with latch (silver, white, black or gold) - **NEW**

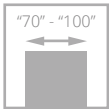

for door leaves with ventilation option



W01 / V01



W01S1 / V1S



W03S1 / V2S



DOOR FRAMES



fixed POL-SKONE system



adjustable DIN system



adjustable DIN SOLID



fixed metal



adjustable metal



adjustable AQUA DIN



fixed DUO



adjustable DIN DUO



adjustable DIN DUO SOLID



adjustable VERTIGO



fixed metal



adjustable metal





















adjustable AQUA DIN DUO



glazing panel

FORTIMO LUX door, version W03S1, adjustable VERTIGO SYSTEM door frame

COLOR RANGE – pp. 303-310

VENEERED GROUP A	 312 limba	 334 European oak						
VENEERED GROUP B	 340 ebony	 390 natural walnut	 404 dark walnut	 405 light walnut	 421 cappuccino	 422 mocha	 424 teak	
	VENEERED GROUP C	 370 whitewashed oak						
	VENEERED GROUP D	 313 classic oak	 460 makassar	 NEW 461 caramel oak	 NEW 462 truffle oak	 NEW 463 chocolate oak		
		VENEERED REALWOOD	 470 nabucco matt	 471 tosca matt	 472 traviata matt	 473 kastano matt		

INCLUDED IN THE PRICE OF THE DOOR
Solid construction made of a wooden stile and rail. The surface is covered with natural veneers, protected by an ecological UV lacquer ensuring color durability and scratch resistance. Vertical elements – vertical grain, horizontal elements – horizontal grain.
tempered glass white matt with a thickness of 4 mm
REBATED SYSTEM
visible brushed nickel hinge “70”-“80” – 2 pcs., “90” – 3 pcs. type K - for door frame DIN system, type C - for wooden door frame, type M silver - for metal door frame
silver latch-bolt lock: for key, cylinder, bathroom lock, without keyhole
NON-REBATED SYSTEM
concealed satin nickel hinge “70”-“80” - 2 pcs., “90” - 3 pcs. magnetic lock, satin chrome: for key, cylinder, bathroom lock, without keyhole

FOR EXTRA CHARGE	
non-standard door sizes	p. 296
width “60” – only versions W01, W01S1	
tempered glass brown matt, graphite matt, transparent with a thickness of 4 mm	
laminated glass VSG 22.1 matt or transparent	
laminated glass VSG 22.1 black color	
door closers, electric strikes	pp. 281, 283
drop seal	
heat recovery ventilation (applies to doors of standard height)	
ventilation undercut (pp. 286-287)	
sliding systems	pp. 168-177
REBATED SYSTEM	
additional visible hinge type M silver	
additional visible hinge type M black	
additional visible hinge type K, type C brushed nickel or black	
change of lock color to black	
NON-REBATED SYSTEM	
additional concealed hinge satin nickel	
change of hinge color to white or black	
change of hinge color to gold	
change of magnetic lock color to white, black or gold	
non-rebated lock with latch (silver, white, black or gold) - NEW	

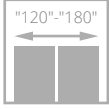
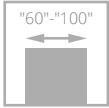

for door leaves with ventilation option



02 / V02



02S6 / V2S6



05 / V05



05S8 / V5S8



08 / V08



08S10 / V8S10



DOOR FRAMES



fixed POL-SKONE system



adjustable DIN system



adjustable DIN SOLID



fixed metal



adjustable metal



adjustable AQUA DIN



INTERSOLID frame

INTERSOLID door, version 02, adjustable SYSTEM DIN door frame

COLOR RANGE – pp. 303-310

VENEERED GROUP A	312 limba	334 European oak				
VENEERED GROUP B	340 ebony	404 dark walnut	405 light walnut	421 cappuccino	422 mocha	424 teak
VENEERED GROUP C	370 whitewashed oak	VENEERED GROUP D		313 classic oak	460 makassar	
VENEERED REALWOOD	470 nabucco matt	471 tosca matt	472 traviata matt	473 kastano matt		

INCLUDED IN THE PRICE OF THE DOOR

Solid construction made of a wooden stile and rail. The surface is covered with natural veneers, protected by an ecological UV lacquer ensuring color durability and scratch resistance.

glass white matt or transparent with a thickness of 4 mm

REBATED SYSTEM

visible hinge, brushed nickel "60"- "80" - 2 pcs., "90" - 3 pcs.

type K - for door frame DIN system, type C - for wooden door frame, type M silver - for metal door frame

silver latch-bolt lock: for key, cylinder, bathroom lock, without keyhole

FOR EXTRA CHARGE

non-standard door sizes p. 296

tempered glass white matt, brown matt, graphite matt, transparent with a thickness of 4 mm

laminated glass VSG 22.1 matt or transparent

laminated glass VSG 22.1 black color

door closers, electric strikes pp. 281, 283

drop seal

heat recovery ventilation not possible

ventilation undercut (pp. 286-287)

sliding systems pp. 168-177

REBATED SYSTEM

additional visible hinge type M silver

additional visible hinge type M black

additional visible hinge type K, type C brushed nickel or black

change of lock color to black

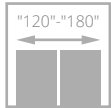
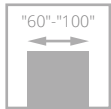

for door leaves with ventilation option



01 / V01



01S6 / V1S6



02 / V02



02S6 / V2S6



03 / V03



03S6 / V3S6



04 / V04



04S8 / V4S8



05 / V05



05S8 / V5S8



06 / V06



06S8 / V6S8



07 / V07



07S10 / V7S10



08 / V08



08S10 / V8S10



09 / V09



09S10 / V9S10

DOOR FRAMES



fixed POL-SKONE system



adjustable DIN system



adjustable DIN SOLID



fixed metal



adjustable metal



adjustable AQUA DIN



fixed DUO



adjustable DIN DUO



adjustable DIN DUO SOLID



adjustable VERTIGO



fixed metal



adjustable metal



adjustable AQUA DIN DUO



INTERSOLID II door, version 08S10, adjustable DIN SYSTEM door frame



wooden muntin



door leaf profile

COLOR RANGE - pp. 303-310

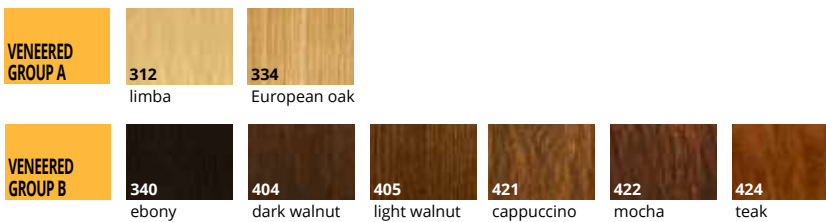

INCLUDED IN THE PRICE OF THE DOOR
Solid construction made of a wooden stile and rail, decorative milled panels. The surface is covered with natural veneers, protected by an ecological UV lacquer ensuring color durability and scratch resistance.
glass white matt or transparent with a thickness of 4 mm
REBATED SYSTEM
visible hinge, brushed nickel "60"- "80" - 2 pcs., "90" - 3 pcs. type K - for door frame DIN system, type C - for wooden door frame, type M silver - for metal door frame
silver latch-bolt lock: for key, cylinder, bathroom lock, without keyhole
NON-REBATED SYSTEM
concealed hinge, satin nickel "60"- "80" - 2 pcs., "90" - 3 pcs. lock magnetic satin chrome: for key, cylinder, bathroom lock, without keyhole

FOR EXTRA CHARGE	
non-standard door sizes	p. 296
tempered glass white matt or transparent with a thickness of 4 mm	
door closers, electric strikes	pp. 281, 283
drop seal	
heat recovery ventilation	not possible
ventilation undercut (pp. 286-287)	
sliding systems	pp. 168-177
REBATED SYSTEM	
additional visible hinge type M silver	
additional visible hinge type M black	
Additional visible hinge type K, type C brushed nickel or black	
change of lock color to black	
NON-REBATED SYSTEM	
additional concealed hinge satin nickel	
change of hinge color to white or black	
change of hinge color to gold	
change of magnetic lock color to white, black or gold	
non-rebated lock with latch (silver, white, black or gold) - NEW	

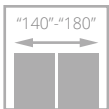
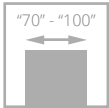

V08



V05



V02

DOOR FRAMES



fixed POL-SKONE system



adjustable DIN system



adjustable AQUA DIN



adjustable REVES system



fixed DUO



adjustable DIN DUO



adjustable VERTIGO



adjustable AQUA DIN DUO



spatial panel with a thickness of 22 mm

KINGSTONE door, version V02, adjustable door frame DIN

COLOR RANGE – pp. 303-310



INCLUDED IN THE PRICE OF THE DOOR

Solid construction made of a wooden stile and rail, covered with two smooth HDF boards with a thickness of 3.5 mm, with decorative milling at the junction with a spatial panel of 22 mm thickness. Finished with SILKWOOD coating – natural veneer covered with ecological paints from the RAL and NCS palettes. Ecological UV lacquer increases resistance to scratches and light exposure.

glass white matt or transparent with a thickness of 4 mm

REBATED SYSTEM

visible hinge, brushed nickel "60"- "80" - 2 pcs., "90" - 3 pcs.
 type K - for door frame DIN system, type C - for wooden door frame,
 type M silver - for metal door frame
 silver latch-bolt lock: for key, cylinder, bathroom lock, without keyhole

NON-REBATED SYSTEM

concealed hinge, satin nickel "60"- "80" - 2 pcs., "90" - 3 pcs.
 magnetic lock, satin chrome: for key, cylinder, bathroom lock, without keyhole

FOR EXTRA CHARGE

non-standard door sizes	p. 296
door closers, electric strikes	pp. 281, 283
drop seal	
heat recovery ventilation	without extra charge
ventilation undercut (pp. 286-287)	
sliding systems	pp. 168-177

REBATED SYSTEM

additional visible hinge type M silver
additional visible hinge type M black
additional visible hinge type K, type C brushed nickel or black
change of lock color to black

NON-REBATED SYSTEM

additional concealed hinge satin nickel
change of hinge color to white or black
change of hinge color to gold
change of magnetic lock color to white, black or gold
non-rebated lock with latch (silver, white, black or gold) - NEW

REVES SYSTEM (reverse rebate)

additional concealed TE hinge, silver
change of TE hinge color to white or black
change of TE hinge color to gold

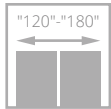
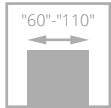

00 / V00



02 / V2S



03SD / V3SD



04 / V4SD



05 / V5SD

DOOR FRAMES



fixed POL-SKONE system



adjustable DIN system



adjustable DIN SOLID



fixed metal



adjustable metal



adjustable AQUA DIN



adjustable REVES system



fixed DUO



adjustable DIN DUO



adjustable DIN DUO SOLID



adjustable VERTIGO



fixed metal



adjustable metal



adjustable AQUA DIN DUO



DECO LUX door, version 00, door frame SYSTEM DIN

COLOR RANGE – pp. 303-310

VENEERED GROUP A	312 limba	334 European oak									
	323 rustic oak	340 ebony	390 natural walnut	404 dark walnut	405 light walnut	421 cappuccino	422 mocha	424 teak			
VENEERED GROUP B	370 whitewashed oak	VENEERED GROUP D	313 classic oak	460 makassar	NEW 461 caramel oak	NEW 462 truffle oak	NEW 463 chocolate oak				
VENEERED GROUP C	470 nabucco matt	471 tosca matt	472 traviata matt	473 kastano matt	450 white matt	451 black matt	452 grey matt RAL 7047	453 indigo RAL 5011	454 sage matt NCS S 4010-G50Y	455 beige NCS S 2005-Y50R	456 grey RAL 7038
VENEERED REALWOOD											
VENEERED SILKWOOD											

INCLUDED IN THE PRICE OF THE DOOR	
Solid construction made of a wooden frame, filled with a layer of "honeycomb" structure. Finished with natural veneers protected with UV lacquer, with visible wood grain pattern. REALWOOD color range – veneer covered with ultra-matt UV lacquer with visible wood grain pattern. SILKWOOD color range – veneer painted with ecological paints from the RAL and NCS palettes.	
glass white matt, brown matt or transparent, 4 mm thick	
tempered glass white matt with a thickness of 4 mm (version 03SD)	
REBATED SYSTEM	
visible hinge silver galvanized "60"-80" - 2 pcs., "90" - 3 pcs.	
type K - for door frame DIN system, type C - for wooden door frame, type M - for metal door frame	
silver latch-bolt lock: for key, cylinder, bathroom lock, without keyhole	
NON-REBATED SYSTEM	
concealed hinge, satin nickel "60"-80" - 2 pcs., "90" - 3 pcs.	
magnetic lock, satin chrome: for key, cylinder, bathroom lock, without keyhole	
FOR EXTRA CHARGE	
non-standard door sizes	p. 296
tempered and laminated glass	p. 302
stile and rail (enabling self-shortening up to 50 mm)	
stile and rail (enabling self-shortening up to 90 mm)	
perforated chipboard filling	
solid chipboard filling (third hinge recommended)	
door closers, electric strikes	pp. 281, 283
reinforcement for door closer	
drop seal	
heat recovery ventilation	without extra charge

ventilation undercut (pp. 286-287)	
sliding systems	pp. 168-177
possibility to order DECO LUX door in mechanical class III (p. 178)	after consultation with the Sales Department
REBATED SYSTEM	
additional visible hinge type M silver galvanized	
additional visible hinge type M black	
additional visible hinge type K, type C silver galvanized or black	
additional visible hinge type T silver	
change of hinge color type T to black or gold	
change of lock color to black	
in the case of a door leaf with a door closer and a DIN or metal door frame, type T hinges should be used in the following quantities: "60"-80" – 3 pcs.; "90"-110" – 4 pcs.; extra charge for additional hinge type T	
NON-REBATED SYSTEM	
additional concealed hinge satin nickel	
change of hinge color to white or black	
change of hinge color to gold	
change of magnetic lock color to white, black or gold	
non-rebated lock with latch (silver, white, black or gold) - NEW	
REVES SYSTEM (reverse rebate) – applies to version 00	
additional concealed TE hinge, silver	
change of TE hinge color to white or black	
change of TE hinge color to gold	

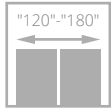
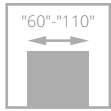

W00 / V00



W01 / V1S

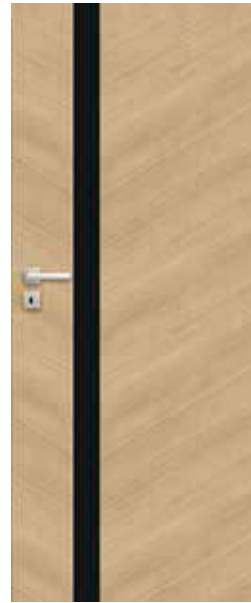

W01 / V1S



W02 / V01



W03 / V03

DOOR FRAMES



adjustable
DIN system



adjustable
DIN SOLID



fixed metal



adjustable metal



adjustable
AQUA DIN



reverse
rebate
SYSTEM



adjustable
REVES system



fixed DUO



adjustable
DIN DUO



adjustable
DIN DUO SOLID



adjustable
VERTIGO



fixed metal



adjustable metal



adjustable
AQUA DIN DUO



grain pattern

ESPINA door, version W03, door frame SYSTEM DIN

COLOR RANGE – pp. 303-310

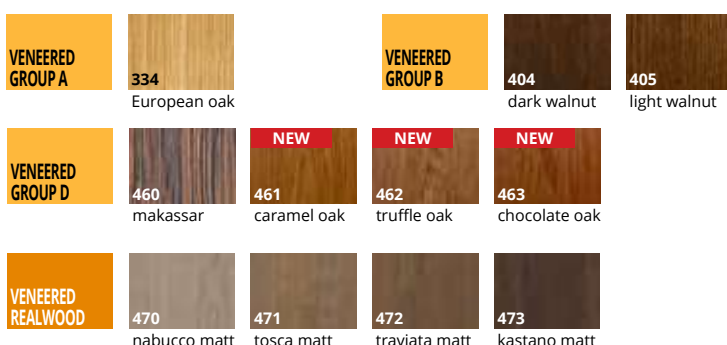

INCLUDED IN THE PRICE OF THE DOOR

Solid construction with a wooden frame, filled with a perforated board. Finished with natural veneers protected with UV lacquer with visible wood grain pattern (VENEERED color range) and ultra-matt UV lacquer with visible wood grain pattern (REALWOOD color range). Decorative wood grain pattern: "herringbone" (versions W00-W02) and "diamond" (version W03).

tempered glass white matt with a thickness of 6 mm

laminated glass VSG 44.2 black with a thickness of 8.5 mm

REBATED SYSTEM

visible hinge, brushed nickel "60"-80" – 2 pcs., "90" – 3 pcs.

type K – for door frame system DIN, type C – for wooden door frame,

type M silver – for metal door frame "

silver latch-bolt lock: for key, cylinder, bathroom lock, without keyhole

NON-REBATED SYSTEM

concealed hinge satin nickel "60"-70" – 2 pcs., "80"-90" – 3 pcs.

magnetic lock, satin chrome: for key, cylinder, bathroom lock, without keyhole

FOR EXTRA CHARGE

non-standard door sizes p. 296

stile and rail (enabling self-shortening up to 50 mm) – does not apply to version W01

stile and rail (enabling self-shortening up to 90 mm) – does not apply to version W01

solid chipboard filling (third hinge recommended)

door closers, electric strikes pp. 281, 283

reinforcement for door closer (does not apply to version W01)

drop seal (does not apply to version W01)

heat recovery ventilation (does not apply to version W01) without extra charge

ventilation undercut (applies to versions W00, W02, W03) (pp. 286-287)

ventilation undercut (applies to version W01) (pp. 286-287)

sliding systems pp. 168-177

REBATED SYSTEM

additional visible hinge type M silver

additional visible hinge type M black

additional visible hinge type K, type C brushed nickel or black

change of lock color to black

in the case of a door leaf with a door closer and a DIN or metal door frame, type T hinges should be used in the following quantities: "60"-80" – 3 pcs.; "90"-110" – 4 pcs.; extra charge for additional hinge type T

NON-REBATED SYSTEM

additional concealed hinge satin nickel

change of hinge color to white or black

change of hinge color to gold

change of magnetic lock color to white, black or gold

non-rebated lock with latch (silver, white, black or gold) - NEW

REVES SYSTEM (reverse rebate)

additional concealed TE hinge, silver

change of TE hinge color to white or black

change of TE hinge color to gold

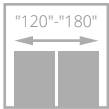
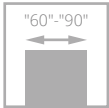

VF1



VF4



VF5

NEW VERSIONS



VF17



VF18



VF19



VF20



VF21



VF22



VF23



VF24

TRANSOM PANEL
(p. 250)



DOOR FRAMES



adjustable
DIN system



adjustable
DIN SOLID



fixed metal



adjustable metal



adjustable
AQUA DIN



adjustable
REVES system



fixed DUO



adjustable
DIN DUO



adjustable
DIN DUO SOLID



adjustable
VERTIGO



fixed metal



adjustable metal



adjustable
AQUA DIN DUO



TEO door, version VF17, adjustable DIN door frame

COLOR RANGE – pp. 303-310

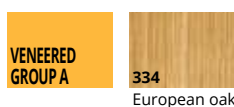

INCLUDED IN THE PRICE OF THE DOOR
Solid construction made of a wooden frame, filled with a solid board. Finished with natural veneers protected by UV lacquer with a visible wood grain. Unique milling made in a black board, protected with lacquer.
REBATED SYSTEM visible black hinge "60"- "80" – 2 pcs., "90" – 3 pcs. type T - for DIN system and metal door frame black latch-bolt lock: for key, cylinder, bathroom lock, without keyhole
NON-REBATED SYSTEM concealed black hinge "60"- "70" – 2 pcs., "80"- "90" – 3 pcs. black magnetic lock: for key, cylinder, bathroom lock, without keyhole

FOR EXTRA CHARGE	
non-standard door sizes	p. 296
stile and rail (enabling self-shortening up to 50 mm)	
stile and rail (enabling self-shortening up to 90 mm)	
door closers, electric strikes	pp. 281, 283
reinforcement for door closer	
drop seal	
heat recovery ventilation	without extra charge
ventilation undercut (pp. 286-287)	
sliding systems	pp. 168-177
REBATED SYSTEM	
additional visible hinge type T black	
in the case of a door leaf with a door closer and a DIN or metal door frame, type T hinges should be used in the following quantities: "60"- "80" – 3 pcs.; "90"- "110" – 4 pcs.; extra charge for additional hinge type T	
NON-REBATED SYSTEM	
additional concealed black hinge	
non-rebated lock with latch, black - NEW	
REVES SYSTEM (reverse rebate)	
additional concealed TE black hinge	

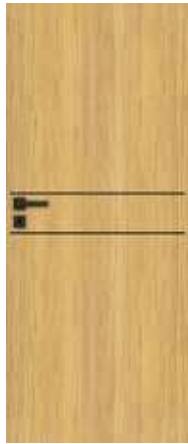
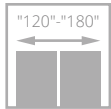
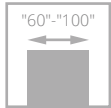

W1 / VD1

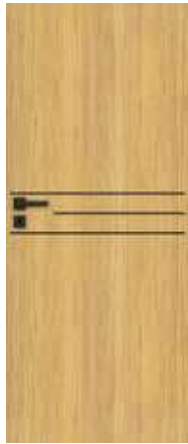

W2 / VD2



W4 / VD4



W5 / VD5



W6 / VD6



W7 / VD7



W8 / VD8



W9 / VD9



W10 / VD10



W11 / VD11



W12 / VD12

NEW VERSION

DOOR FRAMES



fixed system
POL-SKONE



adjustable
DIN system



adjustable
DIN SOLID



fixed metal



adjustable
metal



adjustable
AQUA DIN



adjustable
REVES system



fixed DUO



adjustable
DIN DUO



adjustable
DIN DUO SOLID



adjustable
VERTIGO

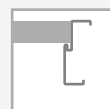

fixed metal



adjustable
metal



adjustable
AQUA DIN DUO



SONATA LUX door, version W2, adjustable DIN door frame



Aluminum decors on the surface of the door leaf in matt copper, matt gold color (version W9, W10, W11, W12)



Aluminum decors on the surface of the door leaf in matt black color (version W9, W10, W11, W12)

COLOR RANGE – pp. 303-310

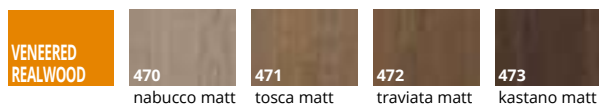
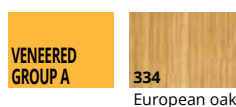

INCLUDED IN THE PRICE OF THE DOOR

The structure of the door leaf consists of a wooden stile and rail, filled with a perforated board. Finished with natural veneers protected with UV lacquer, with visible wood grain pattern. REALWOOD color range – veneer covered with ultra-matt UV lacquer with visible wood grain pattern. Decorative aluminum decors in matt black, matt copper, matt gold color – versions W1-W8 with a width of 7.2 mm; versions W9-W12 with a width of 25 mm and 10 mm

REBATED SYSTEM

visible silver galvanized hinge “60”-“70” – 2 pcs., “80” “90” – 3 pcs.
type K - for door frame DIN system, type C - for wooden door frame,
type M - for metal door frame
silver latch-bolt lock: for key, cylinder, bathroom lock, without keyhole

NON-REBATED SYSTEM

concealed satin nickel hinge “60”-“70” - 2 pcs., “80” “90” - 3 pcs.
magnetic lock, satin chrome: for key, cylinder, bathroom lock, without keyhole

FOR EXTRA CHARGE

non-standard door sizes	p. 296
stile and rail (enabling self-shortening up to 50 mm) – does not apply to versions W8, W9, W10, W11, W12	
stile and rail (enabling self-shortening up to 50 mm) – does not apply to versions W8, W9, W10, W11, W12	
solid chipboard filling (3rd hinge recommended)	
door closers, electric strikes	pp. 281, 283
reinforcement for door closer	
drop seal	
heat recovery ventilation	without extra charge
sliding systems	pp. 168-177
aluminum edge (non-rebated system)	
edge of the door leaf in black color	without extra charge
heat recovery ventilation	without extra charge
ventilation undercut (pp. 286-287)	

REBATED SYSTEM

additional visible hinge type M silver galvanized
additional visible hinge type M black
additional visible hinge type K, type C galvanized silver or black
change of lock color to black
in the case of a door leaf with a door closer and a DIN or metal door frame, type T hinges should be used in the following quantities: “60”-“80” – 3 pcs.; “90”-“110” – 4 pcs.; extra charge for additional hinge type T

NON-REBATED SYSTEM

additional concealed hinge satin nickel
change of hinge color to white or black
change of hinge color to gold
change of magnetic lock color to white, black or gold
non-rebated lock with latch (silver, white, black or gold) - NEW

REVES SYSTEM (reverse rebate)

additional concealed TE hinge, silver
change of TE hinge color to white or black
change of TE hinge color to gold

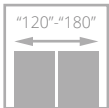
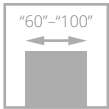

WHITE/BROWN MATT TEMPERED GLASS



A01 / V1SA



A02 / V2SA

BLACK LAMINATED GLASS



A01 / V1SA black glass



A02 / V2SA black glass

WHITE MATT LAMINATED GLASS



A01 / V1SA



A02 / V2SA

DOOR FRAMES



fixed POL-SKONE system



adjustable DIN system



adjustable DIN SOLID



fixed metal



adjustable metal



adjustable AQUA DIN



adjustable REVES system



fixed DUO



adjustable DIN DUO



adjustable DIN DUO SOLID



adjustable VERTIGO



fixed metal



adjustable metal



adjustable AQUA DIN DUO

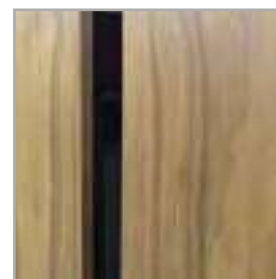

black pane

ESTATO LUX door, version A01, DIN DUO SYSTEM door frame

COLOR RANGE – pp. 303-310

VENEERED GROUP A									
	312 limba	334 European oak							
VENEERED GROUP B									
	323 rustic oak	340 ebony	390 natural walnut	404 dark walnut	405 light walnut	421 cappuccino	422 mocha	424 teak	
	VENEERED GROUP D								
		313 classic oak	460 makassar	461 caramel oak	462 truffle oak	463 chocolate oak			
		NEW			NEW			NEW	
	VENEERED REALWOOD								
		470 nabucco matt	471 tosca matt	472 traviata matt	473 kastano matt				

INCLUDED IN THE PRICE OF THE DOOR
The structure of the door leaf consists of a wooden stile and rail, filled with a perforated board. Finished with natural veneers protected by UV lacquer with a visible wood grain. REALWOOD - veneer covered with ultra-matt UV lacquer with visible wood grain.
tempered glass white matt with a thickness of 6 mm (version A01-58 mm, A02-208 mm)*
laminated safety glass VSG 44.2 in white matt or black color, thickness 8.5 mm (glazing width version A01-58 mm, A02-208 mm)*
REBATED SYSTEM
visible silver hinge "60"- "80" – 2 pcs., "90" – 3 pcs.
type T - for DIN system and metal door frame,
type C - for wooden door frame
silver latch-bolt lock: for key, cylinder, bathroom lock, without keyhole
NON-REBATED SYSTEM
concealed hinge satin nickel "60"- "70" – 2 pcs., "80"- "90" – 3 pcs.
Magnetic lock satin chrome: for key, cylinder, bathroom lock, without keyhole

FOR EXTRA CHARGE	
non-standard door sizes	p. 296
tempered glass graphite matt or transparent with a thickness of 6 mm	
tempered glass Linea black VSG/ESG 44.4 with double-sided ornament (below 10 pcs.)	
tempered glass Linea black VSG/ESG 44.4 with double-sided ornament (above 10 pcs.)	
solid chipboard filling (third hinge recommended)	
door closers, electric strikes	pp. 281, 283
drop seal	not possible
heat recovery ventilation	without extra charge
ventilation undercut – version A01 (pp. 286-287)	
ventilation undercut – version A02 (pp. 286-287)	
sliding systems	not possible
REBATED SYSTEM	
additional visible hinge type T silver	
additional visible hinge type T black	
change of hinge color type T to black or gold	
additional visible hinge type C silver or black	
change of lock color to black	
NON-REBATED SYSTEM	
additional concealed hinge satin nickel	
change of hinge color to white or black	
change of hinge color to gold	
change of magnetic lock color to white, black or gold	
non-rebated lock with latch (silver, white, black or gold) - NEW	
REVES SYSTEM (reverse rebate)	
additional concealed TE hinge, silver	
change of TE hinge color to white or black	
change of TE hinge color to gold	

* dimension tolerance +/- 2 mm

FOLDING

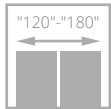
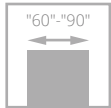

00 / V00



00 / V00 double-leaf door

DOOR FRAMES



adjustable
DIN DUO



adjustable
DIN DUO SOLID



adjustable
AQUA DIN DUO

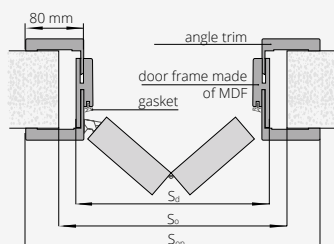

Folding door DIN DUO door frame

type	single-leaf door			double-leaf door			
	S_o	S_d	S_{op}	type	S_o	S_d	S_{op}
"60"	690	652	792	"60"+"60"	1305	1267	1407
"70"	790	752	892	"70"+"70"	1505	1467	1607
"80"	890	852	992	"80"+"80"	1705	1667	1807
"90"	990	952	1092	"90"+"90"	1905	1867	2007

HEIGHT	H_o	H_d	H_s	H_{op}
	2065	2059	2020	2113

S_d , H_d - dimension on the outer side of the door frame including the reinforcing strip in the lintel (16 mm)

S_o , H_o - proposed installation dimension

S_{op} , H_{op} - dimensions on the outer side of the trim

H_s - height of the door leaf



handle

FOLDING DOOR, version 00, adjustable DIN DUO door frame

COLOR RANGE – pp. 303-310

ECO TOP*	LAMISTONE CPL	SILKSTONE	SILKSTONE CPL 0.5 mm	UNI MAT PLUS	LAMINATED CPL 0,2 mm	LAMINATED CPL 0,5 mm*
VENEERED GROUP A	VENEERED GROUP B	VENEERED GROUP C	VENEERED GROUP D	VENEERED SILKWOOD	VENEERED REALWOOD	PAINTED
						MONO1 MAT

*available for extra charge after consultation with the Sales Department

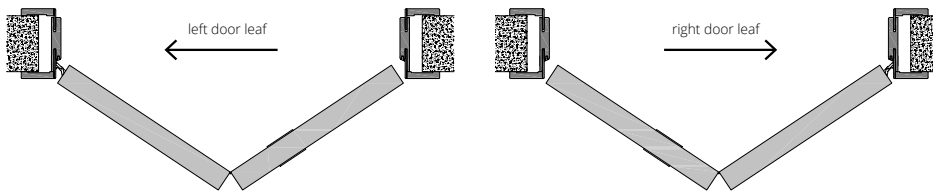

<p>INCLUDED IN THE PRICE OF THE DOOR</p> <p>The door leaf is constructed from a wooden stile and rail covered with two smooth HDF boards, either laminated or veneered. The standard filling is a layer with a "honeycomb" structure.</p> <p>track and concealed adjustable hinges in the door leaf</p> <p>hinges: concealed adjustable satin nickel "60"- "80" – 2 pcs., "90" – 3 pcs.</p> <p>round plastic handle</p> <p>NON-REBATED SYSTEM</p> <p>concealed satin nickel hinge "60"- "80" – 2 pcs., "90" – 3 pcs.</p> <p>round plastic handle</p>	<p>FOR EXTRA CHARGE</p> <p>non-standard door sizes p. 296</p> <p>perforated chipboard filling</p> <p>solid chipboard filling (third hinge recommended)</p> <p>extra charge for CPL laminate 0.5 mm ("90+" - "110")</p> <p>NON-REBATED SYSTEM</p> <p>additional concealed hinge satin nickel</p> <p>single-point mortise hook lock WB (only for single-leaf door) p. 280</p>
--	--

LUMEN

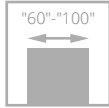

width "60" – "80" width "90" width "100"
 pane of transparent glass, white satin
 pane of brown satin glass, graphite satin

ADJUSTABLE DOOR FRAME LUMEN (ZL)



WIDTH

single-leaf door					
type	S _o	S _d	S _s	S _{opA}	S _{opB}
"60"	676	646	617	748	788
"70"	776	746	717	848	888
"80"	876	846	817	948	988
"90"	976	946	917	1048	1088
"100"	1076	1046	1017	1148	1188

HEIGHT

H _o	H _d	H _s	H _{opA}	H _{opB}
2053	2043	2016	2093	2113

S_o – width of the installation opening
 S_d – width of the door on the external side of the door frame
 S_s – width of the door leaf
 S_{opA} – width of the door frame after trims "60"
 S_{opB} – width of the door frame after trims "80"

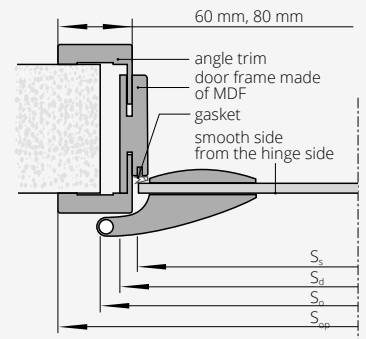

H_o – height of the installation opening
 H_d – height of the door on the outer side of the door frame
 H_s – height of the door leaf
 H_{opA} – height of the door frame after trims "60"
 H_{opB} – height of the door frame after trims "80"

LUMEN	adjustment range (mm)	ECO TOP	for laminated			VENEERED		
			LAMISTONE CPL	PAINTED 9003*	MONO1 MAT	MONO2 MAT	GROUP A	GROUP B
ZL 1A	75-85							
ZL 1B	85-95							
ZL 2	95-120							
ZL 3	120-140							
ZL 4	140-160							
ZL 5	160-180							
ZL 6	180-200							
ZL 7	200-220							
ZL 8	220-240							
ZL 9	240-260							
ZL 10	260-280							
ZL 11	280-300							

*LUMEN door frame in PAINTED color range available only with trims of 80 mm width, in other color ranges trims of 60 mm and 80 mm width



LUMEN door, version I, adjustable LUMEN door frame



handle



hinge

RONDO FITTINGS



QUADRO FITTINGS



FITTINGS



aluminum
EV1-Deco 114



aluminum
stainless steel
107



black**

handle + hinges	QUADRO
handle + WB + hinges	QUADRO
handle + WC + hinges	QUADRO
handle-knob + small lock + hinges*	QUADRO
	RONDO

*door set with electric strike

** lower hinge with black cover, upper hinge black painted

WB - for cylinder

WC - for bathroom lock

INCLUDED IN THE PRICE OF THE DOOR

The door is made of a pane of tempered glass suspended on an adjustable LUMEN door frame available in the full POL-SKONE color range.

tempered glass satin white matt, brown matt, graphite matt or transparent, 8 mm thick

ornament on the side opposite to the hinges

handle height for standard glass pane height - 1038 mm from the bottom edge of the pane

FOR EXTRA CHARGE

non-standard door sizes p. 296

fixed and adjustable metal door frame pp. 260-261

fail-secure electric strike JIS 1710 12-24 V AC/DC (including strike plate and milling for electric strike)

fail-secure electric strike BIRA HARTTE XS12U 12V AC/DC (including strike plate and milling for electric strike)

fail-secure electric strike with switch BIRA HARTTE XS12UW 12V AC/DC (including strike plate and milling for electric strike)

fail-safe electric strike BIRA HARTTE XS12R 12V DC (including strike plate and milling for electric strike)

ventilation undercut

PREMIUM GLASS wall-mounted sliding system p. 172

*LUMEN door frame in PAINTED color range available only with trims of 80 mm width, in other color ranges trims of 60 mm and 80 mm width

LUMEN LOFT

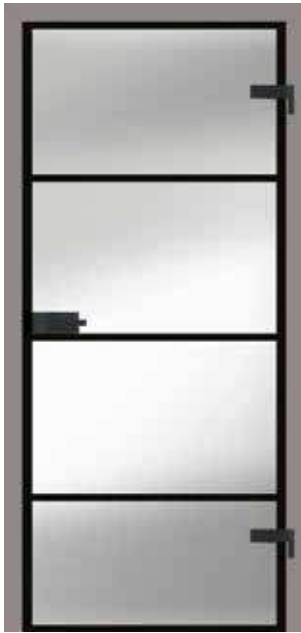
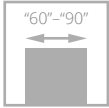

V1



V2

"60" - "80"

transparent glass, white or black decor
white satin glass, white or black decor



V3



V4

"90"

transparent glass, white or black decor
white satin glass, white or black decor

DOOR FRAMES



fixed metal
LUMEN



adjustable metal
LUMEN



adjustable
DIN system
LUMEN



LUMEN LOFT door, version V2, adjustable LUMEN door frame



handle



hinge

RONDO FITTINGS



QUADRO FITTINGS



FITTINGS	aluminum EV1-Deco 114	aluminum stainless steel 107	black**
	handle + hinges		QUADRO
handle + WB + hinges		QUADRO	RONDO
handle + WC + hinges		QUADRO	RONDO
handle-knob + small lock + hinges*		QUADRO	RONDO

*door set with electric strike
 ** lower hinge with black cover, upper hinge black painted

WB - for cylinder
 WC - for bathroom lock

INCLUDED IN THE PRICE OF THE DOOR

The door is made of a pane of tempered glass suspended on an adjustable LUMEN door frame available in the full POL-SKONE color range.

8 mm thick tempered glass pane, transparent, with single-sided black or white decor made using screen printing method

handle height for standard glass pane height – 1038 mm from the bottom edge of the pane

FOR EXTRA CHARGE

non-standard door sizes	p. 296
fixed and adjustable metal door frame	pp. 260-261
fail-secure electric strike JIS 1710 12-24 V AC/DC (including strike plate and milling for electric strike)	
BIRA HARTTE XS12U 12V AC/DC fail-secure electric strike (including strike plate and milling for electric strike)	
fail-secure electric strike with switch BIRA HARTTE XS12UW 12V AC/DC (including strike plate and milling for electric strike)	
fail-safe electric strike BIRA HARTTE XS12R 12V DC (including strike plate and milling for electric strike)	
ventilation undercut	

*LUMEN door frame in PAINTED color range available only with trims of 80 mm width, in other color ranges trims of 60 mm and 80 mm width

SLIDING WALL-MOUNTED system

WALL-MOUNTED SYSTEM EQUIPMENT

standard: brass longitudinal handle, matt chrome (U4) p. 280

optionally:

handles or hook lock

SP60* soft closer for single-leaf doors p. 280

SP60* soft closer for double-leaf doors _____

BIAS soft closer for single-leaf doors _____

BIAS soft closer for double-leaf doors _____

*Application of the SP60 soft closer for the wall-mounted system: – single-leaf door width "60" – "100" – double-leaf door width "60" + "60" – "90" + "90"

Due to the installation system of the SP60 soft closer, it cannot be used in the following doors: ETIUDA – A02; PASSO; ESTADO/ESTATO LUX – A02

In glazed doors, the ornament is on the outside; in doors with a lock, the lock is blocked from the inside.

In double-leaf doors: right – lock in the right door leaf; left – lock in the left door leaf.

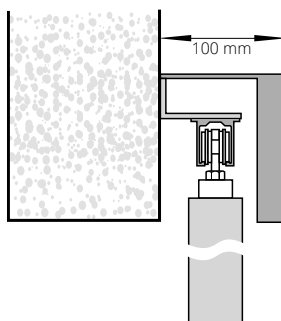

wall-mounted sliding system (MDF cover made in the color range of the door leaf)

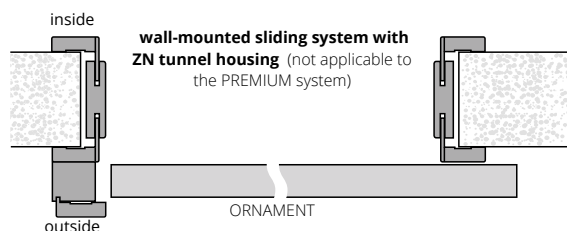

wall-mounted sliding system with ZN tunnel housing (not applicable to the PREMIUM system)

COVER LENGTHS FOR THE WALL-MOUNTED SYSTEM

"60" – 1795 mm	"60"+"60" – 3448 mm*
"70" – 1795 mm	"70"+"70" – 3448 mm*
"80" – 1795 mm	"80"+"80" – 3448 mm*
"90" – 2045 mm	"90"+"90" – 3948 mm*
"100" – 2295 mm	

*The cover is made of two elements; cover height is 110 mm



guide rail of the wall-mounted system



cover and approach post of the wall-mounted system



doors in the WALL-MOUNTED SLIDING SYSTEM



WALL-MOUNTED SYSTEM

the price includes: guide rail, cover and approach post*

single-leaf door	PAINTED 9003	MONO1 MAT	MONO2 MAT	ECO TOP	LAMISTONE CPL	VENEERED		
					SILKSTONE	GROUP A	GROUP B	GROUP C, D REALWOOD
					UNI MAT PLUS			
					wood-like laminate			
extra charge for the selected model of interior door leaf								
"60"- "90"								
"100"								

EXTRA CHARGES

color range MONO3 MAT (extra charge for the basic color RAL 9003)	
for double-leaf doors	
door lower by 50 mm	
door higher by 50 mm or 100 mm	
door higher by 150 mm or 200 mm	
trims joined at a 90° angle (only 80 mm trims)	
ventilation options	pp. 286-287

* optionally, a version with a wall enclosure system ("finishing tunnel") - price depends on wall thickness
 ** it is possible to manufacture only the sliding door leaf (extra charge) + handle price

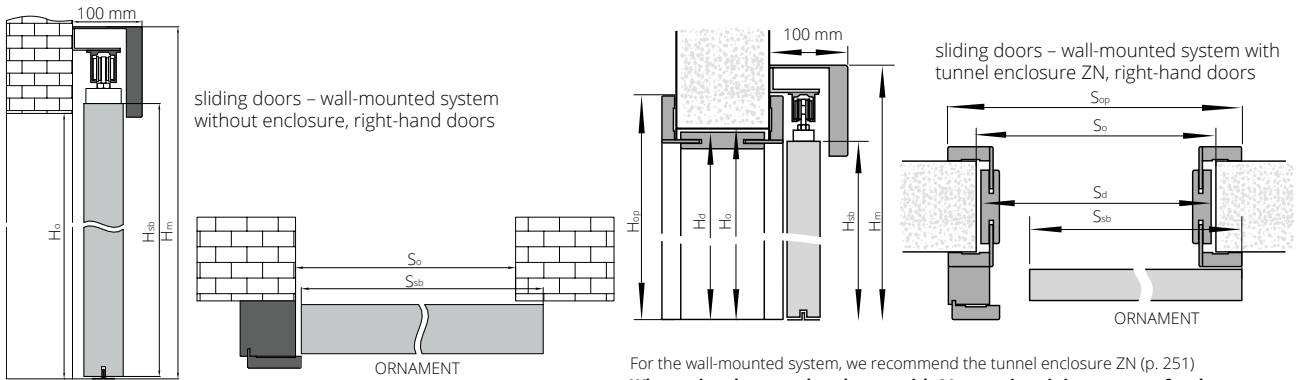

WIDTH		
single-leaf door	double-leaf door	
dimensions on the external side of the door leafs (S _{sb} , H _{sb}) and the installation opening (S _o , H _o)	(without approach post) dimensions on the external side of the door leafs (S _{sb} , H _{sb}) and the installation opening (S _o , H _o)	
type	S _{sb}	S _o
"60"	644	620
"70"	744	720
"80"	844	820
"90"	944	920
"100"	1044	1020

WIDTH					
single-leaf door			double-leaf door		
dimensions on the external side of the door leafs (S _{sb} , H _{sb}) and the installation opening (S _o , H _o)			(without approach post) dimensions on the external side of the door leafs (S _{sb} , H _{sb}) and the installation opening (S _o , H _o)		
type	S _{sb}	S _d	S _o	S _{opA}	S _{opB}
"60"	644	646	670	748	788
"70"	744	746	770	848	888
"80"	844	846	870	948	988
"90"	944	946	970	1048	1088
"100"	1044	1046	1070	1148	1188

HEIGHT	H _o	H _{sb}	H _m
	2020	2033	2138

HEIGHT	H _d	H _o	H _{opA}	H _{opB}	H _{sb}	H _m
	2043	2055	2093	2113	2033	2138

Dimensional tolerance ± 1 mm

H_m - height on the external side of the cover
 H_{op} - height on the external side of the trim
 H_o - height of the installation opening
 H_d - height on the external side of the door frame
 H_{sb} - height on the external side of the door leaf

S_{op} - width on the external side of the trims
 S_o - width of the installation opening
 S_d - width on the external side of the door frames
 S_{sb} - width on the external side of the door leaf

SLIDING WALL-MOUNTED PREMIUM system

EQUIPMENT FOR WALL-MOUNTED PREMIUM SYSTEM

standard: longitudinal handle in matt chrome color (U4)	p. 280
optionally: handles for sliding door leaves	p. 280

WALL-MOUNTED PREMIUM SYSTEM

the price includes: cover with guide rail (aluminum components)
for single-leaf door
for double-leaf door
It is possible to manufacture only the sliding door leaf + handle
price

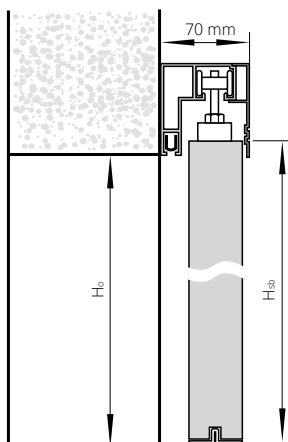

COVER LENGTHS FOR WALL-MOUNTED PREMIUM SYSTEM

"60"	1800 mm
"70"	1800 mm
"80"	1800 mm
"90"	2000 mm
"60"+"60"	1800 + 1800 mm
"70"+"70"	1800 + 1800 mm
"80"+"80"	1800 + 1800 mm
"90"+"90"	2000 + 2000 mm

Hm – height on the external side of the cover
Ho – height of the installation opening
Hsb – height on the external side of the door leaf
Hd – height on the external side of the door frame
So – width of the installation opening
Ssb – width on the external side of the door leaf
Sd – width on the external side of the door frame

WIDTH

single-leaf door dimensions on the external side of the door leaves (Ssb, Hsb) and the installation opening (So, Ho)			double-leaf door dimensions on the external side of the door leaves (Ssb, Hsb) and the installation opening (So, Ho)		
type	S _{sb}	S _o	type	S _{sb}	S _o
"60"	644	620	"60"+"60"	1288	1240
"70"	744	720	"70"+"70"	1488	1440
"80"	844	820	"80"+"80"	1688	1640
"90"	944	920	"90"+"90"	1888	1840

height: (Hsb) 2033, (Ho) 2020, height from floor level to the upper edge of the cover strip – 2103 mm



door in the PREMIUM WALL-MOUNTED SLIDING system



SLIDING WALL-MOUNTED MOVI system



DOOR LEAF CONSTRUCTION

Door leaf in the non-rebated system. The door is constructed from a **wooden stile and rail** covered with two smooth HDF boards with ECO TOP, LAMISTONE CPL, SILKSTONE surfaces, laminated, veneered, and painted. The standard filling is a layer with a "honeycomb" structure. The nominal thickness of the door leaf is 40 mm.

DOOR LEAF FINISH

Smooth surface painted, veneered, laminated, or in ECO TOP, LAMISTONE CPL, SILKSTONE finishes.

EQUIPMENT

STANDARD:

U4 longitudinal handle, matt chrome

OPTIONAL:

perforated chipboard filling

door leaf lower by 50 mm without extra charge

door leaf higher by 50 mm

door leaf higher by 100 mm

door leaf higher by 150 mm

door leaf higher by 200 mm



For the MOVI sliding system, it is not possible to make a tunnel-type installation.

The price of the complete MOVI system = price of the MOVI door leaf + price of the MOVI sliding system

MOVI SLIDING SYSTEM

door leaf width
"70" - "100"
"110"

DOOR LEAF FOR MOVI SLIDING SYSTEM

door leaf width	ECO TOP	LAMISTONE CPL	LAMINATED CPL 0.2 mm	PAINTED 9003*	MONO1 MAT	MONO2 MAT	VENEERED		ESPINA	
		SILKSTONE					GROUP A	GROUP B	GROUP C, D	GROUP A
"70" - "90"										
"100" - "110"										

closed				opened (left door)			
WIDTH				HEIGHT			
dimension	S _S	S _O	S _P	dimension	H _S	H _O	
"70"	744	644	526	door leaf lower by 50 mm	2040	1980	
"80"	844	744	626	standard door leaf	2090	2030	
"90"	944	844	726	door leaf higher by 50 mm	2140	2080	
"100"	1044	944	826	door leaf higher by 100 mm	2190	2130	
				door leaf higher by 150 mm	2240	2180	
				door leaf higher by 200 mm	2290	2230	

S_S - door width
 S_O - width of the installation opening
 S_P - passage width
 H_S - height of the door leaf
 H_O - height of the installation opening

SLIDING PREMIUM GLASS WALL-MOUNTED system

The price of Premium Glass wall-mounted door = price of 8 mm glass pane + price of the set of Premium Glass wall-mounted set + longitudinal handle or disc handle



Premium Glass wall-mounted set, aluminium silver finish. The set includes:

rail with a length of 1900 mm

two running carriages

2 pcs. opening limiters

floor guide

2 pcs. side end caps

1 pc. closing damper

Glass pane, tempered glass satin white/brown/graphite or transparent, thickness 8 mm:

pane transparent glass, satin white

width "70"-80"

width "90"

pane of brown satin glass, graphite satin

width "70"-80"

width "90"

Handles:

disc handle Ø 57 mm stainless steel

longitudinal handle length 550 mm, high-grade steel



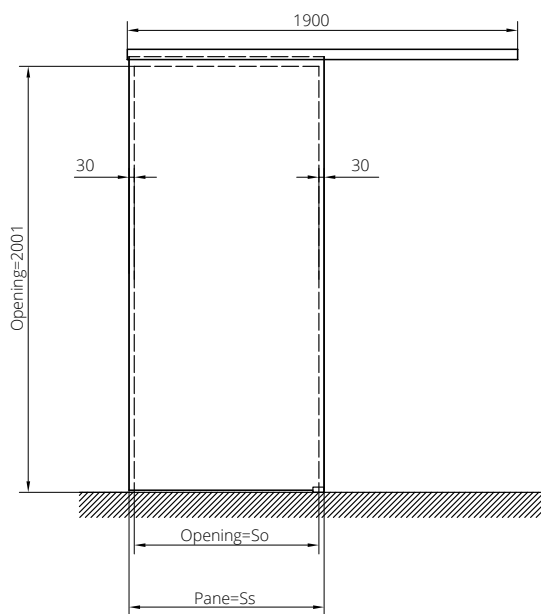
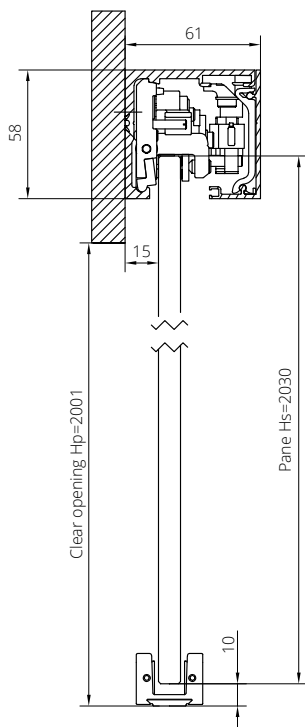

Left door with longitudinal handle

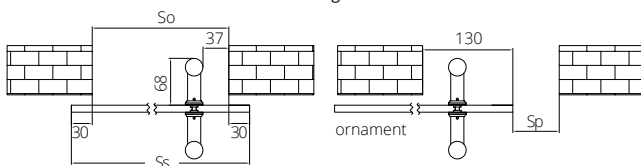

Left door with disc handle

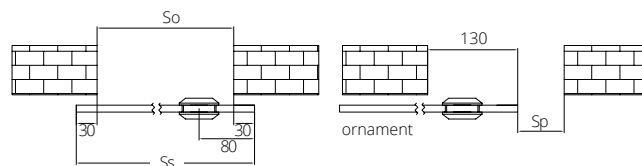

DIMENSIONS

	Ss	So
width "70"	717	657
width "80"	817	757
width "90"	917	857

DIMENSIONS

	Ss	So	Sp
width "70"	717	657	527
width "80"	817	757	627
width "90"	917	857	727



SLIDING SYSTEM FOR WALL INSTALLATION

EQUIPMENT

hook lock (chrome) with lock	
brushes for the system	
manufacture of the door leaf only for the sliding sys.	+ price of the handle
replacement of lock with WC lock from key lock	
cassettes for sliding door system for wall installation*	
handles for sliding doors for wall installation	p. 280
SP60** damper for single-leaf door	
SP60** damper for double-leaf door	

It is possible to order a structure and cassette 100 mm and 200 mm higher.
It is possible to make an asymmetrical structure - after consultation with the Sales Department.

SLIDING DOORS FOR WALL INSTALLATION, RIGHT-LEFT SYMMETRICAL

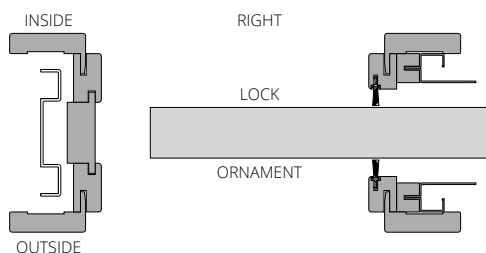

single cassette (100 or 125 mm)	
dimensions of door leafs	
"60" (G/60 PLUS)	
"70" (G/70 PLUS)	
"80" (G/80 PLUS)	
"90" (G/90 PLUS)	
"100" (G/100 PLUS)	
extra charges	
cassette higher by 100 mm Ho=2175 mm	to the price of a single cassette
cassette higher by 200 mm Ho=2275 mm	to the price of a single cassette
for synchronization system (simultaneous opening) in double-leaf door	to the price of a double cassette

double cassette (100 or 125 mm)	
dimensions of door leafs	
"60"+"60" (GG/60 PLUS)	
"70"+"70" (GG/70 PLUS)	
"80"+"80" (GG/80 PLUS)	
"90"+"90" (GG/90 PLUS)	
"100"+"100" (GG/100 PLUS)	
additional assortment	
white brush SB 01	
black brush SB 03	

*cassettes for the sliding door system for wall installation (the minimum thickness of a single or double cassette with G/K casing is: 100 mm for flat door leafs; 125 mm for door leafs with version and glazed with frames)

**Use of the SP60 soft closer for the system hidden in the wall:
 - single-leaf door width "60" - "100"
 - double-leaf door width "60" + "60" - "90" + "90" without synchronization of simultaneous closing of door leafs or double-leaf door width "80" + "80" - "90" + "90" with synchronization of simultaneous closing of door leafs.
 Due to the SP60 soft closer installation system, it cannot be used in doors: ETIUDA - A02; PASSO; ESTADO/ESTATO LUX - A02

Lack of symmetry in the case of doors with pattern/decoration



doors in the SLIDING SYSTEM FOR WALL INSTALLATION



SYSTEM FOR WALL INSTALLATION

The price of the installation system = price of the selected door leaf + price of the cassette + price for the complete installation set for single-leaf door hidden in the wall according to the tables below

The price of the DUO installation system = price of the selected door leaf + price of the cassette + price for the complete installation set for single-leaf door hidden in the wall according to the tables below

VARIANT I Complete installation set for single-leaf door hidden in the wall for 100 mm cassette

For door leaves: ARCO, ETIUDA, MODERN, INTERSOLID II, SEMPRE, SEMPRE LUX, FORTIMO, FORTIMO LUX, SONATA, ESTADO, SEDO, EGRO, VERI, MODO, SUBITO, IMPULS, FIORD (full), DECO LUX, SUBLIME, HAPTIC, ESTADO LUX, TIARA, CAMBIO, DECO, ESPINA, PASSO, MODESTO, SAMOS, UNITO, TEO, ESTO, ZENN, SENTO, MAGRO, FORTO, LAURA

single-leaf door	ECO TOP	PAINTED 9003	MONO1 MAT	MONO2 MAT	LAMISTONE CPL	VENEERED		
					SILKSTONE	GROUP A	GROUP B	GROUP C, D REALWOOD
					UNI MAT PLUS			
range in mm								
100-106								

VARIANT II Complete installation set for single-leaf door hidden in the wall for 125 mm cassette (full or glazed versions)

For door leaves: ARCO, IMPULS, ETIUDA, DECO, FIORD (glazed), CAMBIO, MODERN, SEMPRE, SEMPRE LUX, INTERSOLID II, FORTIMO, FORTIMO LUX, SONATA, SUBLIME, ESTADO, ESTADO LUX, VILANO, HAPTIC, TIARA, VERTIGO, DECO LUX, ESPINA, PASSO, SEDO, CREATO, EGRO, VERI, MODO, SUBITO, MODESTO, SAMOS, UNITO, TEO, ESTO, ZENN, INVERNO, MAESTO, SENTO, RIFLO, MAGRO, FORTO, LAURA

single-leaf door	ECO TOP	PAINTED 9003	MONO1 MAT	MONO2 MAT	LAMISTONE CPL	VENEERED		
					SILKSTONE	GROUP A	GROUP B	GROUP C, D REALWOOD
					UNI MAT PLUS			
range in mm								
125-140								
140-160								
160-180								
180-200								
200-240								
240-280								
280-320								

VARIANT III Complete installation set for single-leaf door hidden in the wall for 125 mm cassette (door leaves with version)

For door leaves: INTERSOLID, ADORE, ROYALE, EMPORE

single-leaf door	ECO TOP	PAINTED 9003	MONO1 MAT	MONO2 MAT	LAMISTONE CPL	VENEERED		
					SILKSTONE	GROUP A	GROUP B	GROUP C, D REALWOOD
					UNI MAT PLUS			
range in mm								
125-131								
131-140								
140-160								
160-180								
180-200								
200-220								
220-260								
260-300								

EXTRA CHARGES

color range MONO3 MAT (extra charge for basic color RAL 9003)

for double-leaf doors

width "100"

bands joined at an angle of 90°

Variant I - Table I

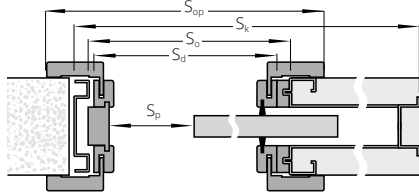

Variant II - Table II

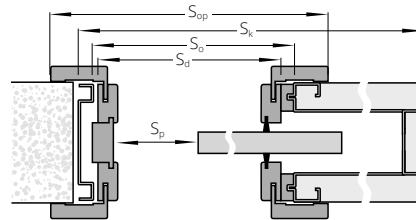

Variant III - Table III

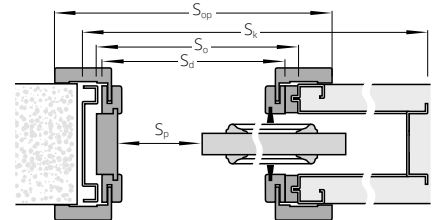

WIDTH

single-leaf door							double-leaf door								
Dimensions on the outside: door leaves (Ssb, Hsb), doors (Sd, Hd)							Dimensions on the outside: door leaves (Ssb, Hsb), doors (Sd, Hd)								
type	Ssb	Sd	So	Sk	Sp	SopA	SopB	type	Ssb	Sd	So	Sk	Sp	SopA	SopB
"60"	644	645	670	1352	530	745	785	"60"+"60"	1288	1256	1290	2610	1070	1356	1396
"70"	744	745	770	1552	630	845	885	"70"+"70"	1488	1456	1490	3010	1270	1556	1596
"80"	844	845	870	1752	730	945	985	"80"+"80"	1688	1656	1690	3410	1470	1756	1796
"90"	944	945	970	1952	830	1045	1085	"90"+"90"	1888	1856	1890	3810	1670	1956	1996
"100"	1044	1045	1070	2152	930	1145	1185								

HEIGHT

Hsb	Hd	Ho	Hk	Hp	HopA	HopB
2033	2043	2075	2120	2021	2093	2113

Ssb – width on the external side of door leaves
 Sd – width on the external side of the structure
 So – width of the installation opening of the structure
 Sk – width on the external side of the cassette
 Sp – passage width
 SopA – width on the external side of the 60 mm trim
 SopB – width on the external side of the 80 mm trim
 Hsb – height on the external side of door leaves
 Hd – height on the external side of the structure
 Ho – height of the installation opening of the structure
 Hk – height on the external side of the cassette
 Hp – passage height
 HopA – height on the external side of the 60 mm trim
 HopB – height on the external side of the 80 mm trim

CASSETTE SYNTESIS LINE

Cassette for door leaf without door frame and trims

No finishing with a wooden door frame or masking trims

ECLISSE Syntesis Line is a cassette designed for a sliding door leaf concealed in the wall, not requiring the use of masking strips. Thanks to this construction, the door panel is discreetly placed in the cassette, resulting in a modern design using the latest technology.



By choosing the Syntesis Line cassette

You create a modern design for the room

The Syntesis Line cassette is designed with minimalist rooms in mind. The idea behind its creation was "less is more." It fits perfectly into the arranged space.

It is there, yet as if it were not

The design of the cassette allows for discreet installation of the door panel. By using the same color for the wall and the door leaf, we create a unique color range for the room.

The door becomes invisible, does not attract attention, and does not constitute a conspicuous element of the interior.



ECLISSE SYNTESIS® LINE for plasterboard wall

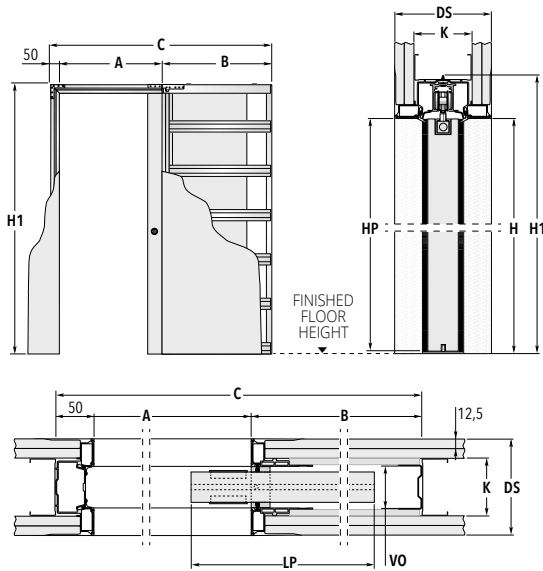

ECLISSE SYNTESIS® LINE DOUBLE for plasterboard wall

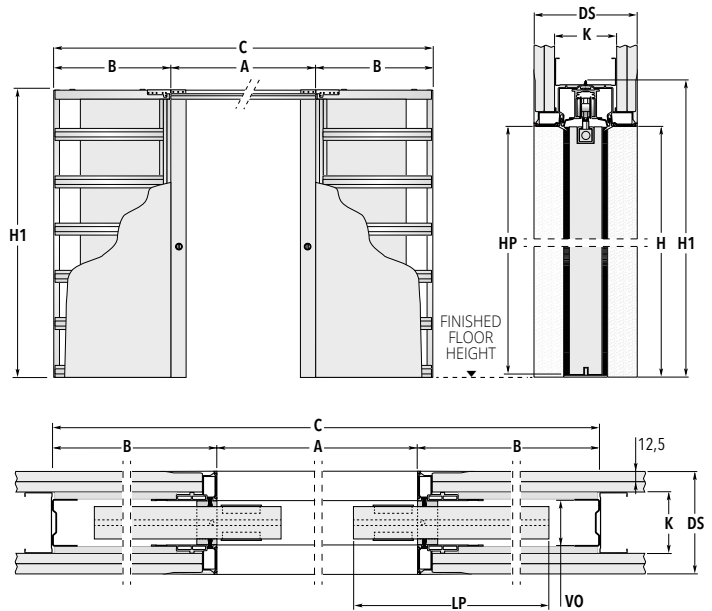

CASSETTE DIMENSION FOR SINGLE-LEAF DOOR

DOOR WIDTH	PASSAGE OPENING A x H	B	EXTERNAL DIMENSIONS C x H1	DOOR LEAF DIMENSIONS	
				LP	HP
"60"	600 x 2048	750	1400 x 2108	625	2040
"70"	700 x 2048	850	1600 x 2108	725	2040
"80"	800 x 2048	950	1800 x 2108	825	2040
"90"	900 x 2048	1050	2000 x 2108	925	2040
"100"	1000 x 2048	1150	2200 x 2108	1025	2040

CASSETTE DIMENSION FOR DOUBLE-LEAF DOOR

DOOR WIDTH	PASSAGE OPENING A x H	B	EXTERNAL DIMENSIONS C x H1	DOOR LEAF DIMENSIONS	
				LP	HP
"60"+"60"	1200 x 2048	750	2700 x 2108	625	2040
"70"+"70"	1400 x 2048	850	3100 x 2108	725	2040
"80"+"80"	1600 x 2048	950	3500 x 2108	825	2040
"90"+"90"	1800 x 2048	1050	3900 x 2108	925	2040
"100"+"100"	2000 x 2048	1150	4300 x 2108	1025	2040

WALL THICKNESS = DS	INTERIOR DIMENSIONS = VS	PROFILE = K
100	54	75 single plasterboard

ECLISSE SYNTESIS LINE CASSETTE DEDICATED TO FLAT DOOR LEAFS (DOES NOT APPLY TO GLAZED DOOR LEAFS)

EXTRA CHARGE FOR ADAPTING THE DOOR LEAF TO THE SYNTESIS LINE CASSETTE TO THE PRICE OF THE DOOR LEAF

SYNTESIS LINE CASSETTE

single cassette, plasterboard version, thickness 100 mm, H=2048 mm, size "60"- "80"

single cassette, plasterboard version, thickness 100 mm, H=2048 mm, size "90"- "100"

double cassette, plasterboard version, thickness 100 mm, H=2048 mm, size "60"- "60" - "80"- "80"

double cassette, plasterboard version, thickness 100 mm, H=2048 mm, size "90"- "90" - "100"- "100"

LEGEND

A - Passage opening
B - Cassette pocket dimension
C - Total cassette width
H - Passage opening height
H1 - Total cassette height

LP - Door leaf width
HP - Door leaf height
DS - Total cassette thickness with 100 mm plasterboard
VO - Interior cassette space 54 mm
K - 75 mm plasterboard profiles



interior doors with panel construction, mechanical class III, version 00, adjustable DIN door frame

DOOR LEAFS mechanical class III with panel construction

- Class 3 mechanical strength, i.e. heavy-duty conditions according to PN-EN 1192:2001
- National Technical Assessment ITB-KOT-2021/2041 edition 1 – rebated version
- Manufactured in accordance with PN-EN 14351-2:2018 – non-rebated version

FOR DOOR LEAFS FOR POL-SKONE METAL DOOR FRAMES, HINGES ARE INCLUDED IN THE PRICE OF THE DOOR FRAME.

FOR DOOR LEAFS FOR METAL DOOR FRAMES OF OTHER MANUFACTURERS, HINGES FOR DOOR LEAFS ARE AVAILABLE FOR EXTRA CHARGE.

In POL-SKONE door leaves with a metal door frame and door closer, T-type hinges are used as standard ("60" - "80" - 3 pcs., "90" - "110" - 4 pcs.)

Doors intended for use in public utility buildings with heavy traffic, as well as in industrial and warehouse buildings, as interior doors serving as closures of construction openings in interior walls between rooms. Particularly recommended for schools, kindergartens, and hospitals.

The door leaf is constructed from a **wooden frame** reinforced with two vertical battens connected with plywood and an enlarged bottom stile and rail; the infill consists of a perforated chipboard.



interior doors with panel construction, mechanical class III, version 00, adjustable DIN door frame

DOOR LEAFS FOR METAL DOOR FRAME, WOODEN DOOR FRAME, DIN III CLASS ADJUSTABLE DOOR FRAME



sys. rebated sys. non-rebated sys. rebated sys. non-rebated sys. rebated sys. rebated sys. non-rebated sys. rebated

VERSION	00	02	03SD	04	05
LAMINATED CPL 0.2 mm					
UNI MAT PLUS					
LAMISTONE					
SILKSTONE					
SILKSTONE CPL 0.5 mm					
PAINTED 9003					
MONO1 MAT					
MONO2 MAT					
MONO3 MAT					
VENEERED GROUP A					
VENEERED GROUP B					
VENEERED GROUP C, D					
SILKWOOD / REALWOOD					

The door leaf is equipped with 3 pcs. hinges: type C (for wooden door frame), type K (for adjustable DIN door frame, III mechanical class), type T (for metal door frame); optionally: DIN door frame, III strength class, with reinforcement for the strike plate in the form of a pine strip; angular strike plate - extra charge to the price of the adjustable DIN door frame, DIN DUO.

EXTRA CHARGE FOR LAMINATED GLASS INSTEAD OF TEMPERED IN DOOR LEAFS III MECHANICAL CLASS

LAMINATED GLASS VSG 22.1 MATT - WHITE MATT

DOOR DIMENSIONS

Fixed wooden door frame:
max. width "110" – 1195 mm, max. height 2267 mm
Adjustable wooden door frame:
max. width "110" – 1195 mm, max. height 2267 mm
Adjustable door frame DIN system III mechanical class:
max. width "100" – 1046 mm, max. height 2243 mm
Fixed metal door frame FD12, FD14:
max. width "110" – 1197 mm, max. height 2268 mm

Adjustable metal door frame:
max. width "110" – 1217 mm, max. height 2278 mm
DIN DUO door frame III class:
max. width "100" – 1052 mm, max. height 2143 mm
Fixed metal door frame DUO:
max. width "100" – 1101 mm, max. height 2168 mm
Adjustable metal door frame DUO:
max. width "100" – 1121 mm, max. height 2178 mm

DOOR LEAF FINISH

Smooth surface painted, veneered, covered with CPL laminate 0.2 mm or 0.5 mm, HPL laminate with thickness from 0.7 mm to 1.0 mm or wood-like foil.

GLAZINGS

Tempered glass 4 mm, laminated 22.1 or VSG 33.1 – p. 302

DOOR FRAMES

Painted, veneered door frame, covered with CPL laminate 0.15 mm or wood-like foil matched to the color range of the door leaf.
Fixed pine wooden optionally with masking strips, quarter round.
Adjustable wooden with widening panels and angular trims.
Adjustable DIN III mechanical class
Adjustable DIN DUO III mechanical class
Made of MDF panels with a thickness of 22 mm with special reinforcement for the strike plate in the form of a pine strip, angular strike plate.

FD12 fixed metal made of steel sheet with a thickness of 1.5 mm.
FD14 fixed metal made of steel sheet with a thickness of 1.5 mm; powder coated as standard in white (RAL 9016, 9003), grey (RAL 7047), brown (RAL 8014), beige (NCS S 2005 Y50R), graphite (RAL 7024), black (RAL 9005).
Adjustable metal/Adjustable metal DUO/Fixed DUO made of steel sheet with a thickness of 1.5 mm; powder coated as standard in white (RAL 9016, 9003), grey (RAL 7047), brown (RAL 8014), beige (NCS S 2005 Y50R), graphite (RAL 7024), black (RAL 9005); consists of the main part and an angular trim inserted into the main part.

ACCESSORIES AND EQUIPMENT

STANDARD equipment:
Door with wooden door frame
- 3 pin hinges type C adjustable in three planes
- latch-bolt lock for patent insert or key
Door with DIN system door frame III mechanical class
- 3 adjustable pin hinges type K or optionally 3 three-part hinges type T
- latch-bolt lock for patent insert or key
Door with metal door frame
- 3 three-part hinges type T
- latch-bolt lock for patent insert or key
Door with DIN DUO system door frame III mechanical class
- 3 concealed adjustable DUO hinges
- latch-bolt lock for patent insert or key

ADDITIONAL equipment:
- solid board filling
- surface door closer
- fail-safe or fail-secure electric strike
- electromagnetic lock
- hinge TYPE T (1 pc.)
- DIN door frame, DIN DUO III mechanical class - extra charge to the price of the adjustable DIN, DIN DUO door frame
- width "100"
- width "110" (applies to rebated version)
- drop seal
- ventilation undercut - pp. 286-287



regarding version 00



REINFORCED DECO INVEST

- 4 mechanical class (single-leaf door, version 00, width "70"- "100") manufactured in accordance with PN-EN 14351-2:2018
- 3 mechanical class (single-leaf door)
- 2 mechanical class (double-leaf door)
- National Technical Assessment ITB-KOT-2021/2041 edition 1

In POL-SKONE door leaves with metal door frame and door closer, type T hinges are used as standard ("70" - "80" - 3 pcs., "90" - "110" - 4 pcs.)

The door is constructed from a stile and rail made of softwood, covered on both sides with HDF boards, with a perforated chipboard core. The edge of the door leaf is protected with a stainless steel profile. FD12 fixed metal door frame, optionally adjustable. The doors have mechanical class 3 or 4.

DECO INVEST door, version 04, metal door frame



DECO INVEST door, version 02, metal door frame

**DECO INVEST
DOOR LEAFS**



VERSION	00	00 (IV class)	01	02	03	04
LAMISTONE CPL			"70"- "90", "90 plus" "100" "110"			
LAMINATED CPL 0.2 mm			"70"- "90", "90 plus" "100" "110"			
LAMINATED CPL 0.5 mm			"70"- "90", "90 plus" "100" "110"			
DOUBLE-LEAF						
LAMISTONE CPL			"70"+ "70" "80"+ "80" "90"+ "90" "100"+ "100"			
LAMINATED CPL 0.2 mm			"70"+ "70" "80"+ "80" "90"+ "90" "100"+ "100"			
LAMINATED CPL 0.5 mm			"70"+ "70" "80"+ "80" "90"+ "90" "100"+ "100"			

door leaves dedicated to the fixed and adjustable metal door frame DECO INVEST



BMD 4 porthole



stainless steel profile

DECO INVEST DOUBLE-LEAF DOOR (II mechanical class)
equipped with:

- reinforced institutional hinges type T
- stainless steel covers on the hinge side
- stainless steel covers on the lock side (active door leaf)
- covers on the strike side with holes for the half-automatic bolt (inactive door leaf)
- fixed metal door frame FD12

**DOOR
DIMENSIONS**

Adjustable metal door frame DECO INVEST (ZO):

Single-leaf door:
max. width: "110" - 1220 mm, max. height 2278 mm
Double-leaf door:
max. width: "100+100" - 2155 mm, max. height 2278 mm

Fixed metal door frame DECO INVEST (FD12):

Single-leaf door:
max. width: "110" - 1200 mm, max. height 2268 mm
Double-leaf door:
max. width: "100+100" - 2135 mm, max. height 2268 mm

**DOOR LEAF
FINISH**

Smooth surface painted, veneered, covered with CPL laminate 0.2 mm or 0.5 mm, HPL laminate with thickness from 0.7 mm to 1.0 mm, or wood-like foil.

GLAZINGS

Tempered glass 4 mm transparent or matt - p. 302

DOOR FRAMES

The door frame is powder-coated as standard in white (RAL 9016, 9003), grey (RAL 7047), brown (RAL 8014), beige (NCS S 2005 Y50R), graphite (RAL 7024).

Fixed metal FD12 made of steel sheet with a thickness of 1.5 mm with a rebate gasket.

Adjustable metal made of steel sheet with a thickness of 1.5 mm (for extra charge).

**ACCESSORIES
AND EQUIPMENT**

Standard equipment:

- mortise lock with stainless steel faceplate, version WK, WB and WC
- reinforced three-part hinges type T ("70"-
"80" - 3 pcs., "90"-
"110" - 4 pcs.)
- reinforcement for door closer
- protection of the door leaf edge with stainless steel (lock side and hinge side)

Additional equipment:

- solid board filling
- surface door closer
- stainless steel grille
- roller lock for key, cylinder, bathroom lock or without keyhole for DECO INVEST door, stainless steel handle
- stainless steel panels glued at the bottom of the door leaf or at the handle height
- additional hinge type T
- version 01, 02, 03: glazing bead made of stainless steel

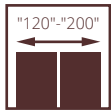
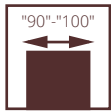

REINFORCED INTERIOR G46

Doors intended for investments, optionally adapted for concealed door closer (single-leaf door), electric strikes with cable duct and half-automatic bolts cooperating with door closers equipped with closing sequence regulation (double-leaf door).

Door leaf in a rebated system. The structure of the door leaf consists of a stile and rail made of softwood, covered on both sides with HDF boards. The infill consists of a solid or perforated board. **The nominal thickness of the door leaf is 46 mm.**

G46 door, fixed wooden door frame



G46 door, fixed wooden door frame

DOOR WITH ADJUSTABLE DOOR FRAME DIN G46

PRICE OF REINFORCED INTERIOR SINGLE-LEAF DOOR G46 = (PRICE OF FLAT SOLID DOOR LEAF REBATED SYSTEM + INFILL PERFORATED BOARD)
+ PRICE OF ADJUSTABLE DOOR FRAME DIN G46

PRICE OF REINFORCED INTERIOR DOUBLE-LEAF DOOR G46 = (2 X PRICE OF FLAT SOLID DOOR LEAF REBATED SYSTEM + INFILL PERFORATED BOARD)
+ PRICE OF ADJUSTABLE DOOR FRAME DIN G46 FOR DOUBLE-LEAF DOOR

DOOR WITH FIXED METAL DOOR FRAME FD12

PRICE OF SINGLE-LEAF REINFORCED INTERIOR DOOR G46 = (PRICE OF FLAT SOLID DOOR LEAF REBATED SYSTEM + INFILL PERFORATED BOARD
+ PRICE OF FIXED METAL DOOR FRAME)

PRICE OF DOUBLE-LEAF REINFORCED INTERIOR DOOR G46 = (2 X PRICE OF FLAT SOLID DOOR LEAF REBATED SYSTEM + INFILL PERFORATED BOARD
+ PRICE OF FIXED METAL DOOR FRAME FOR DOUBLE-LEAF DOOR)

DOOR WITH ADJUSTABLE METAL DOOR FRAME G46

PRICE OF SINGLE-LEAF REINFORCED INTERIOR DOOR G46 = (PRICE OF FLAT SOLID DOOR LEAF REBATED SYSTEM + INFILL PERFORATED BOARD
+ PRICE OF ADJUSTABLE METAL DOOR FRAME G46)

PRICE OF DOUBLE-LEAF REINFORCED INTERIOR DOOR G46 = (2 X PRICE OF FLAT SOLID DOOR LEAF REBATED SYSTEM + INFILL PERFORATED BOARD
+ PRICE OF ADJUSTABLE METAL DOOR FRAME G46 FOR DOUBLE-LEAF DOOR)

ADJUSTABLE DOOR FRAME DIN G46

for single-leaf door		LAMISTONE CPL	laminated CPL 0.2	PAINTED 9003	MONO1 MAT	MONO2 MAT	MONO3 MAT	VENEERED		
symbol	range [mm]	SILKSTONE						GROUP A	GROUP B	GROUP C, D
		UNI MAT PLUS								
ZU1	77-87									
ZU2	87-112									
ZU3	112-132									
ZU4	132-152									
ZU5	152-172									
ZU6	172-192									
ZU7	192-212									
ZU8	212-232									
ZU9	232-252									
ZU10	252-272									
ZU11	272-292									
ZU12	292-312									

double-leaf door - extra charge

reinforcement for door closer

extra charge for CPL 0.5 mm for doors with CPL coating
(extra charge for standard door height)

IN THE CASE OF USING CONCEALED OR SURFACE-MOUNTED DOOR CLOSERS, IT IS NECESSARY TO ORDER 4 HINGES FOR WIDTHS "90"- "100".

DOOR DIMENSIONS	<p>G46 door, single-leaf door adjustable door frame DIN: "100" - max. width 1046, max. height 2243 mm fixed metal door frame FD12: "100" - max. width 1097, max. height 2268 mm adjustable metal door frame FD61: "100" - max. width 1117, max. height 2278 mm</p>	<p>G46 door, double-leaf door adjustable door frame DIN: "100"+"100" - max. width 2080, max. height 2243 mm fixed metal door frame FD12: "100"+"100" - max. width 2131, max. height 2268 mm adjustable metal door frame FD61: "100" + "100" - max. width 2151, max. height 2278 mm</p>
DOOR LEAF FINISH	Smooth surface painted, veneered, covered with CPL laminate 0.2 mm or 0.5 mm, HPL laminate with thickness from 0.7 mm to 1.0 mm, or wood-like foil.	
DOOR FRAMES	<p>Painted, veneered, or laminated door frame with CPL 0.15 mm, CPL 0.2 mm or foil matched to the color range of the door leaf. Adjustable DIN – made of MDF panels with a thickness of 22 mm. Adjustable metal G46 made of steel sheet with a thickness of 1.5 mm, consists of the main part and an angular band inserted into the main part.</p>	<p>Fixed metal FD12 made of steel sheet with a thickness of 1.5 mm with a rebate gasket. Door frames are powder-coated as standard in white (RAL 9016 and RAL 9003), grey (RAL 7047), brown (RAL 8014), beige (NCS S 2005 Y50R), graphite (RAL 7024), black (RAL 9005). It is possible to paint door frames in non-standard colors from the RAL or NCS palette after consultation with the Sales Department.</p>
ACCESSORIES AND EQUIPMENT	<p>Standard equipment: - perforated chipboard door with adjustable DIN door frame - 3 adjustable pin hinges type K or optionally 3 three-part hinges type T - latch-bolt lock for patent insert or key door with FD12 metal door frame - 3 three-part hinges type T - latch-bolt lock for patent insert or key - no possibility of ventilation options in the form of ventilation grilles or ventilation sleeves</p>	<p>Additional equipment: - concealed door closer Dormakaba ITS 96 2-4 or Geze Boxer 2-4 - surface door closer - additional mortise or surface lock - electromagnetic strike - color range SILKSTONE CPL 0.5 - drop seal - - reinforcement for door closer - solid chipboard filling - fail-safe or fail-secure electric strike with cable duct - ventilation undercut, ventilation gap or panel with ventilated surface</p>
		<p>Additionally for double-leaf door - fail-safe or fail-secure electric strike with cable duct - semi-automatic flush bolts - surface-mounted door closers with closing sequence regulation</p>

NEW

rebated
SYSTEM

"60"- "100"

90 PLUS
INVESTMENT
WIDTH



DOOR LEAFS

ISOLA

- Thermal transmittance coefficient for door with door frame:
 - DIN AQUA is $U_d=1.3 \text{ W/m}^2\cdot\text{K}$
 - metal is $U_d=1.6 \text{ W/m}^2\cdot\text{K}$
- Doors manufactured in accordance with standard **PN-EN 14351-2:2018**

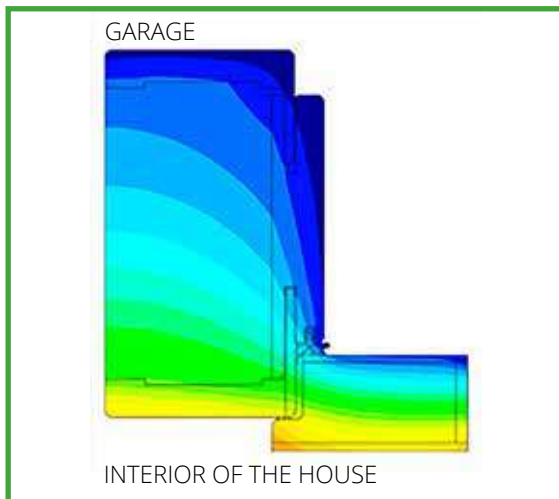

Intended for use in construction as **interior doors**, serving as closures for openings in interior walls between rooms characterized by different air temperatures, e.g. garages.

The door leaf is constructed from a solid wooden structural frame covered on both sides with HDF boards. A thermal insert is used as the filling. A drop seal is included as standard.

ISOLA interior door, version V00, adjustable DIN door frame



ISOLA interior door, version V00, adjustable DIN door frame

ISOLA



VERSION

V00

ECO TOP
UNI MAT PLUS
LAMISTONE
SILKSTONE
LAMINATED CPL 0.2 mm
PAINTED RAL 9003
MONO1 MAT
MONO2 MAT
MONO3 MAT
VENEERED GROUP A
VENEERED GROUP B
VENEERED GROUP C, D
SILKWOOD / REALWOOD

DOOR DIMENSIONS

Adjustable DIN AQUA door frame (REBATED SYSTEM):
max. width "100" – 1018 mm, max. height 2220 mm
Fixed metal door frame FD12, FD14:
max. width "100" – 1097 mm, max. height 2268 mm

Adjustable metal door frame ZO:
max. width "100" – 1117 mm, max. height 2278 mm

DOOR LEAF FINISH

Smooth surface painted, veneered, covered with CPL laminate 0.2 mm or 0.5 mm, HPL laminate with a thickness from 0.7 mm to 1.0 mm or wood-like foil.

DOOR FRAMES

Adjustable DIN AQUA
Made of high-quality MDF with increased moisture resistance. Painted, veneered, covered with CPL laminate 0.2 mm or wood-like foil matched to the color range of the door leaf.

Metal fixed FD12 or FD14
Made of steel sheet with a thickness of 1.5 mm. Powder coated as standard in white (RAL 9016, 9003), grey (RAL 7047), brown (RAL 8014), beige (NCS S 2005 Y50R), graphite (RAL 7024), black (RAL 9005).

Metal adjustable ZO
Made of steel sheet with a thickness of 1.5 mm, consisting of the main part and an angular band inserted into the main part. Powder coated as standard in white (RAL 9016, 9003), grey (RAL 7047), brown (RAL 8014), beige (NCS S 2005 Y50R), graphite (RAL 7024), black (RAL 9005).

ACCESSORIES AND EQUIPMENT

Standard equipment:
- drop seal
REBATED SYSTEM
- visible hinge, silver galvanized "60"- "80" - 2 pcs., "90" - 3 pcs., type K - for DIN system door frame, type M - for metal door frame
- silver latch-bolt lock: for key or cylinder

Additional equipment:
- additional visible hinge type M, silver galvanized
- additional visible hinge type M, black
- additional visible hinge type K, silver galvanized or black
- change of rebated lock color to black
- surface door closer
- REG-GO package (recommended)

non-rebated
SYSTEM

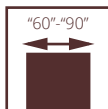

Class II



SPECIAL SWING

- 2nd class of mechanical strength according to PN-EN 1192:2001
- National Technical Assessment ITB-KOT-2020/1608 ed.1

Doors intended for use in construction as interior doors (without fire resistance and acoustic properties), serving as closures for openings in interior walls between rooms. Doors particularly intended for catering establishments.

Solid or glazed door leaf in a non-rebated system. The structure of the door leaf consists of a **stile and rail made of softwood** covered on both sides with HDF boards. The standard filling is a honeycomb structure layer (optionally a perforated board). The nominal thickness of the door leaf is 40 mm.

SWING door, version 00, fixed wooden door frame



SWING door, version 00 with porthole, fixed wooden door frame



SWING



VERSION	00	00 with porthole	02	00	00 with porthole
PAINTED 9003					
UNI MAT PLUS					
LAMISTONE CPL					
SILKSTONE					
LAMINATED CPL 0.5 mm					
VENEERED GROUP A					
VENEERED GROUP B					
VENEERED GROUP C, D					

PRICE OF SINGLE-LEAF SWING DOOR = PRICE OF SOLID DOOR LEAF IN SELECTED COLOR RANGE + PRICE OF FIXED WOODEN REBATED DOOR FRAME + EXTRA CHARGE

PRICE OF DOUBLE-LEAF SWING DOOR = 2 x PRICE OF SOLID DOOR LEAF IN SELECTED COLOR RANGE + PRICE OF FIXED WOODEN REBATED DOOR FRAME FOR DOUBLE-LEAF DOOR + EXTRA CHARGE

DIMENSIONS OF SWING DOORS

width "60"	769x2076 mm	width "60"+"60"	1418x2076 mm
width "70"	869x2076 mm	width "70"+"70"	1618x2076 mm
width "80"	969x2076 mm	width "80"+"80"	1818x2076 mm
width "90"	1069x2076 mm	width "90"+"90"	2018x2076 mm

DOOR DIMENSIONS

Fixed wooden door frame:
 Single-leaf door:
 max. width "90" – 1069 mm, max. height 2276 mm
 Double-leaf door:
 max. width "90+90" – 2018 mm, max. height 2276 mm

DOOR LEAF FINISH

Smooth surface painted, veneered, covered with CPL laminate 0.2 mm or 0.5 mm, HPL laminate with a thickness from 0.7 mm to 1.0 mm, or wood-like foil.

GLAZINGS

Standard tempered glass with a thickness of 4 mm or optionally laminated.

DOOR FRAMES

Painted, veneered door frame, covered with CPL laminate 0.15 mm or foil matched to the color range of the door leaf.

Fixed pine wooden – optionally with masking strips.

ACCESSORIES AND EQUIPMENT

Standard equipment:
 - pivot hinge: height up to 2076 mm - 3 pcs. height 2176 mm or 2276 mm – 4 pcs.

Additional equipment:
 - roller lock
 - porthole
 - stainless steel panels
 - pivot hinges in black color - without extra charge

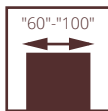

door HIGRO, version W02, fixed metal non-rebated HIGRO door frame

SPECIAL HIGRO

mechanical class: class 2 of mechanical strength requirements, i.e. medium operating conditions
resistance to climatic conditions:
class 3 according to PN-EN 12219:2002
door approved for sale on the basis of the PN-EN 14351-2:2018 standard

Door in a non-rebated system. The structure of the door leaf consists of a polyurethane stile and rail reinforced with plywood, covered on both sides with HPL laminate of 2 mm thickness. The filling consists of a special thermal insulation insert.

The door is intended for use in residential, public utility, industrial, and warehouse buildings as an interior door closing a construction opening in an interior wall between rooms. The door is intended for rooms where the permissible relative air humidity is up to 90%, and the temperature does not exceed 65°C.

The door must not be exposed directly to water.

The door is particularly intended for rooms with increased relative air humidity and temperature, in accordance with the manufacturer's operating instructions.

When installing the door in rooms with a high concentration of chlorine, there is a risk of corrosion on fittings, panels, and portholes made of stainless steel.



door HIGRO, version W03, adjustable metal non-rebated HIGRO door frame

HIGRO

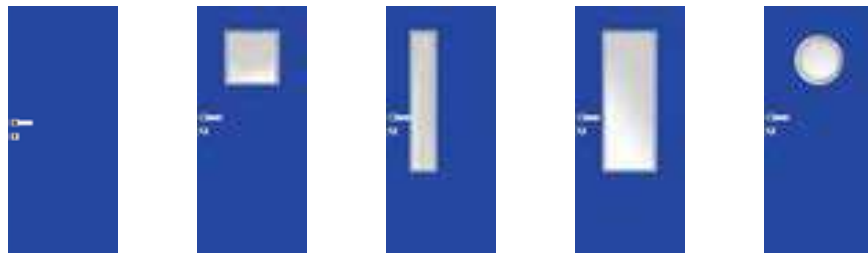

VERSION W00 W01 W02 W03 W04

H-01 (grey), H-02 (white), H-05 (blue), H-06 (anthracite)

HIGRO fixed steel door frame in RAL 9016, RAL 7047, RAL 5010, RAL 7024 color, width "60" - "100"

ADJUSTABLE NON-REBATED DOOR FRAME FOR HIGRO DOOR LEAFS

for single-leaf door	
VERSION	wall width range [mm] "60" - "100"
FD71	110-140
FD72	140-170
FD73	170-200
FD74	200-230
FD75	230-260
FD76	260-290
FD77	290-320
FD78	320-350
FD79	350-380

standard: white (RAL 9016), grey (RAL 7047), blue (RAL 5010), anthracite (RAL 7024)

extra charge for 1 piece of additional TECTUS hinge by Simonswerk, stainless steel AISI 316 - set (top and bottom) -

PANELS MADE OF ACID-RESISTANT SHEET (1 set)

width "60"	width "70"	width "80"	width "90"	width "90 plus", "100"
			variant A	
			variant D	
			variant E, F, G, H	
			brushed sheet metal	

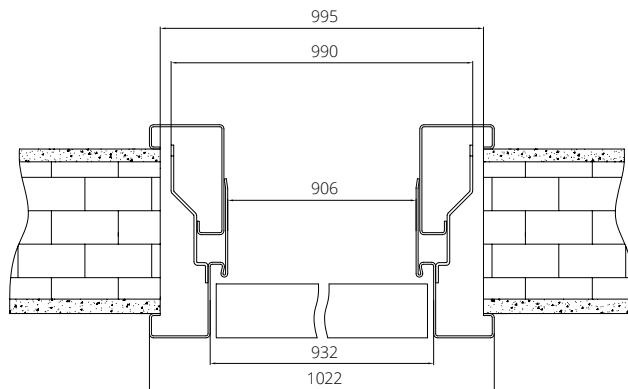

Adjustable metal door frame width "90"

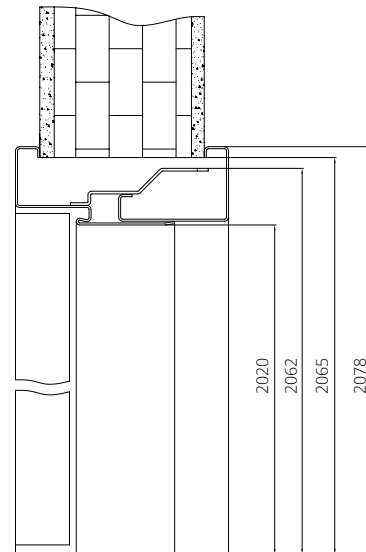

DOOR DIMENSIONS

Fixed metal door frame HIGRO:

Single-leaf door:
 "60" - 702x2068 mm, "70" - 802x2068 mm, "80" - 902x2068 mm,
 "90" - 1002x2068 mm, "90 plus" - 1027x2068 mm
 max. width "100" - 1102 mm, max. height 2268 mm
 - door lower by 50 mm or 100 mm - without extra charge
 - door with a height of 2168 mm
 - door with a height of 2268 mm

Adjustable metal door frame HIGRO:

Single-leaf door:
 "60" - 722x2078 mm, "70" - 822x2078 mm, "80" - 922x2078 mm,
 "90" - 1022x2078 mm, "90 plus" - 1047x2078 mm
 max. width "100" - 1122 mm, max. height 2278 mm
 - door lower by 50 mm or 100 mm - without extra charge
 - door with a height of 2178 mm
 - door with a height of 2278 mm

DOOR LEAF FINISH

Smooth surface covered with HPL laminate with a thickness of 2 mm.

GLAZINGS

Toughened white matt glass with a thickness of 4 mm or safety white matt glass with a thickness of 4 mm.

DOOR FRAMES

Fixed non-rebated metal with rebate gasket made of galvanized sheet metal with a thickness of 1.5 mm.

Adjustable non-rebated metal made of galvanized sheet metal with a thickness of 1.5 mm in the color of the door leaf surface.

ACCESSORIES AND EQUIPMENT

Standard equipment:

- single-point mortise lock, spacing 72 mm, **bathroom lock spacing 78 mm**
- hinges made of AISI 304 stainless steel, powder-coated in grey RAL 7047 (2 pcs.); it is possible to paint the hinges in another color from the RAL palette according to the Client's order
- version W04: BMD3 porthole lacomat glass

Additional equipment:

- surface door closer
- drop seal
- ventilation grille made of acid-resistant steel
- Higro handle and Higro lower escutcheon made of stainless steel
- panels made of acid-resistant steel glued at the bottom of the door leaf or at the height of the handle
- additional ZOX adjustment for adjustable non-rebated door frame (increasing the wall width range by 650 mm)
- porthole made of acid-resistant steel - lacomat/clear glass (extra charge for version W04)



GAMMA door, fixed metal door frame

SPECIAL GAMMA

mechanical class: class 3 of strength requirements
mechanical, i.e. heavy-duty conditions of use
acoustic insulation
class $D_1 = 35$, $D_2 = 35$, class $R_w = 37$ dB
doors approved for sale on the basis of
PN-EN 14351-2:2018

Door in a rebated system. The structure of the door leaf consists of a **stile and rail made of softwood**, covered on both sides with HDF board with a thickness of 5 mm and a lead insert with a thickness of 1 mm (total thickness of lead insert 2 mm for the door leaf). The filling is made of chipboard. The doors are intended for use in public utility buildings (hospitals, clinics, and medical offices) as well as industrial and warehouse buildings – as interior entrance doors, closing openings in interior walls between the corridor and rooms where X-ray radiation is emitted.



GAMMA door, fixed metal door frame

GAMMA



GAMMA FIXED WOODEN DOOR FRAME

VERSION for single-leaf door

LAMINATED CPL 0.2 mm
UNI MAT PLUS
LAMISTONE CPL
SILKSTONE
PAINTED 9003
VENEERED GROUP A
VENEERED GROUP B
VENEERED GROUP C, D

VERSION single-leaf

LAMINATED CPL 0.2 mm
UNI MAT PLUS
LAMISTONE CPL
SILKSTONE
PAINTED 9003
VENEERED GROUP A
VENEERED GROUP B
VENEERED GROUP C, D

LD6 GAMMA STRIP

VERSION for single-leaf door

LAMINATED CPL 0.2 mm
UNI MAT PLUS
LAMISTONE CPL
SILKSTONE
PAINTED 9003
VENEERED GROUP A
VENEERED GROUP B
VENEERED GROUP C, D

GAMMA ADJUSTABLE WOODEN DOOR FRAME

for single-leaf door

VERSION	range in [mm]	LAMISTONE SILKSTONE UNI MAT PLUS	LAMINATED CPL 0.2 mm	PAINTED	VENEERED GROUP A	VENEERED GROUP B	VENEERED GROUP C, D
ZG1	92-112						
ZG2	112-136						
ZG3	136-180						
ZG4	180-202						
ZG5	202-246						
ZG6	246-268						
ZG7	268-312						
ZG8	312-334						
ZG9	334-378						
ZG10	378-402						

GAMMA METAL DOOR FRAME WITH LEAD SHEET STRIP

DOOR FRAME TYPE	wall width range [mm]	width in the clear opening "60" - "90"
FIXED FD12		
	ZO1 (95-125)	
	ZO2 (125-155)	
	ZO3 (155-185)	
	ZO4 (185-215)	
ADJUSTABLE	ZO5 (215-245)	
	ZO6 (245-275)	
	ZO7 (275-305)	
	ZO8 (305-335)	
	ZO9 (335-365)	

DOOR DIMENSIONS

Fixed or adjustable wooden door frame:

single-leaf door:
max. width: "110" - 1195 mm, max. height 2067 mm

Fixed metal door frame:

single-leaf door:
max. width: "110" - 1197 mm, max. height 2068 mm

Adjustable metal door frame:

single-leaf door:
max. width: "110" - 1217 mm, max. height 2078 mm

Double-leaf doors are approved for sale based on Individual Technical Documentation and after consultation with the Sales Department.

DOOR LEAF FINISH

Smooth surface painted, veneered, covered with CPL laminate 0.2 mm or 0.5 mm, HPL laminate with a thickness from 0.7 mm to 1.0 mm, or wood-like foil.

DOOR FRAMES

Fixed or adjustable wooden GAMMA with lead insert.
Fixed or adjustable metal GAMMA made of 1.5 mm sheet metal with lead insert. Powder coated as standard in white (RAL 9016 and

RAL 9003), grey (RAL 7047), brown (RAL 8014), beige (NCS S 2005 Y50R), graphite (RAL 7024), black (RAL 9005).

ACCESSORIES AND EQUIPMENT

Standard equipment:

- single-point mortise lock
- 3 pcs. object, angle hinges - width "60"- "110"
- drop seal

Additional equipment:

- stainless steel panels glued at the bottom of the door leaf or at the handle height
- door closer, electric strike, electromagnetic lock
- width "100"
- width "110"



Class II



TYPE A door, version 00, adjustable DIN SYSTEM door frame

ACOUSTIC POL-SKONE

SOUNDPROOF TYPE A / TYPE B

mechanical class: class 2 strength requirements
mechanical, i.e. medium operating conditions
National Technical Assessment ITB-KOT-2021/2041
edition 1

Single-leaf door **SOUNDPROOF** in the system rebated. The structure of the door leaf consists of a **stile and rail made of softwood** covered on both sides with HDF board. Filling made of solid chipboard (type A) or special POL-SKONE construction (type B). Door leaf with drop seal.

Single- or double-leaf door **SOUNDPROOF DUO** in a non-rebated system. The structure of the door leaf consists of a **stile and rail made of softwood** covered on both sides with HDF board. Filling made of solid chipboard (type A) or special POL-SKONE construction (type B). The door is available in single- and double-leaf versions with a wooden door frame (fixed DUO or adjustable DUO). Door leaf with a seal drop seal.

ACOUSTIC INSULATION R_w [dB]

	door frame DIN	wooden door frame	metal door frame
TYPE A	27	27	27
TYPE B	37	32	37
TYPE A DUO (single- and double-leaf)	-	27	-
TYPE B DUO (single-leaf)	-	37	-
TYPE B DUO (double-leaf)	-	32	-



TYPE A door, version 00, adjustable DIN SYSTEM door frame

**DOOR LEAF
TYPE A/TYPE B**



VERSION	TYPE A	TYPE B
UNI MAT PLUS		
LAMISTONE CPL		
SILKSTONE		
SILKSTONE CPL 0.5 mm		
LAMINATED CPL 0.2 mm		
PAINTED 9003		
MONO1 MAT		
MONO2 MAT		
MONO3 MAT		
VENEERED GROUP A		
VENEERED GROUP B		
VENEERED GROUP C, D		
SILKWOOD / REALWOOD		

**EXTRA CHARGES FOR NON-STANDARD
DIMENSIONS OF SOUNDPROOF DOORS**

adjustable door frame DIN
height up to 2143 mm - extra charge*
height up to 2243 mm - extra charge*
height up to 2300 mm - extra charge*
wooden door frame (fixed or adjustable)
height 2167 mm - extra charge*
height 2267 mm - extra charge*
height 2367 mm (fixed) - extra charge*
height 2467 mm, 2500 mm (fixed) - extra charge*
metal door frame (fixed FD12 or adjustable)
height 2168 mm (fixed) or 2178 mm (adjustable) - extra charge*
height 2268 mm (fixed) or 2278 mm (adjustable) - extra charge*
DUO door frame (fixed or adjustable)
height 2167 mm - extra charge**
height 2267 mm - extra charge**
height 2367 mm (fixed) - extra charge***
height 2467, 2500 mm (fixed) - extra charge***

* extra charge for the door (door leaf+door frame)
 ** extra charge for the door (door leaf+door frame) + extra charge for an additional concealed hinge (1 pc.)
 *** extra charge for the door (door leaf+door frame) + extra charge for an additional concealed hinge (2 pcs.)

Color range of metal door frames (p. 311)

NUMBER OF HINGES FOR SOUNDPROOF DOORS

adjustable door frame DIN (type K)	wooden door frame fixed or adjustable (type C)	metal door frame fixed FD12 or adjustable (type M)	DUO door frame fixed or adjustable (concealed hinge)
height [mm] / number of hinges			
height 2043 - 3 pcs. for width "60"- "90"	height 2067 mm - 3 pcs. for width "60"- "90"	height 2068 mm (fixed), 2078 mm (adjustable) - 3 pcs. for width "60"- "100"	height 2067 - 2 pcs. width "60"- "80" - 3 pcs. width "90"- "100"
height 2143 - 3 pcs.	height 2167 mm - 3 pcs.	height 2168 mm (fixed), 2178 mm (adjustable) - 3 pcs.	height 2167 - 3 pcs.
height 2243 - 4 pcs.	height 2267 mm - 4 pcs.	height 2268 mm (fixed), 2278 mm (adjustable) - 4 pcs.	height 2267 - 3 pcs.
height 2300 - 4 pcs.	height 2367 mm (fixed) - 4 pcs.	-	height 2367 mm (fixed) - 4 pcs.
-	height 2467 mm (fixed) - 4 pcs.	-	height 2467 mm (fixed) - 4 pcs.
-	height 2500 mm (fixed) - 4 pcs.	-	height 2500 mm (fixed) - 4 pcs.

Non-standard heights (maximum height of door with DIN door frame - 2300 mm - 4 pcs.; maximum height of door with wooden door frame - 2500 mm)

DOOR DIMENSIONS

TYPE A, TYPE B

Fixed wooden door frame:
 max. width "110" - 1195 mm, max. height 2500 mm
Adjustable wooden door frame:
 max. width "110" - 1195 mm, max. height 2267 mm
Adjustable DIN door frame:
 max. width "100" - 1046 mm, max. height 2300 mm
Adjustable metal door frame:
 max. width "110" - 1217 mm, max. height 2278 mm
Fixed metal door frame FD12: max. width: "110" - 1197 mm, max. height 2268 mm

TYPE A Duo, TYPE B Duo

Fixed wooden door frame, adjustable DUO:
 Single-leaf door:
 max. width "100" - 1101 mm, max. height 2500 mm
 Double-leaf door:
 max. width "100+100" - 2116 mm, max. height 2500 mm

DOOR LEAF FINISH

Smooth surface painted, veneered, covered with CPL laminate 0.2 mm or 0.5 mm, HPL laminate with a thickness from 0.7 mm to 1.0 mm, or wood-like foil.

DOOR FRAMES

Door frame painted, veneered, covered with CPL laminate 0.15 mm or foil matched to the color range of the door leaf.
Fixed pine wooden - optionally with masking strips, quarter round.
Adjustable wooden with widening panels and angular trims.
Adjustable DIN - made of MDF panels with a thickness of 22 mm.
Adjustable DUO wooden with extension panels and angle trims.
Fixed DUO pine wooden (TYPE A Duo, TYPE B Duo) - optionally with masking strips, quarter round.

Fixed metal FD12 made of 1.5 mm thick steel sheet with rebate gasket.
Adjustable metal made of 1.5 mm thick steel sheet.
 Door frames are powder coated as standard in white (RAL 9016 and RAL 9003), grey (RAL 7047), brown (RAL 8014), beige (NCS S 2005 Y50R), graphite (RAL 7024), black (RAL 9005). It is possible to paint door frames in non-standard colors from the RAL or NCS palette after consultation with the Sales Department.
 The door frame consists of a main part and an angle trim inserted into the main part.

ACCESSORIES AND EQUIPMENT

Standard equipment:
TYPE A, TYPE B
 - pivot hinges adjustable in 3 planes
 - latch-bolt lock for patent insert or key
 - drop seal
TYPE A Duo, TYPE B Duo
 - concealed hinge (adjustable in 3 planes)
 - magnetic lock for patent insert or key for single-leaf door
 - latch-bolt lock for patent insert or key for double-leaf door
 - drop seal

Additional equipment:
 - surface door closer
 - additional mortise or surface lock
 - fail-secure or fail-safe electric strike (TYPE A, TYPE B)
 - electromagnetic lock
 - panoramic peephole - stainless steel ; brass, anthracite, black matt
 - electronic hotel locks
 - width "100"
 - width "110"
 - door higher by 50 mm or 100 mm
 - door higher by 150 mm or 200 mm
 - door higher by 250 mm or 300 mm
 - door higher by 350 mm or 400 mm
 - door lower by 50 mm or 100 mm
 - double-leaf door - no possibility to use an electric strike

It is not possible to use stainless steel covers on the edges of the door leaves. No possibility to use aluminum decors in TYPE B version.

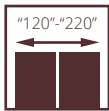

ACOUSTIC POL-SKONE

AKUSTIK 32 dB mechanical class III

- acoustic insulation
- single-leaf: class $D_1 - 30$, $D_2 - 25$, class $R_w=32$ dB
- double-leaf: class $D_1 - 25$, $D_2 - 25$, class $R_w=27$ dB
- 3rd class of mechanical strength according to PN-EN 1192:2001 standard
- National Technical Assessment ITB-KOT-2018/0407 ed.2



AKUSTIK 32 dB door, III mechanical class, fixed wooden door frame

SOUND-INSULATING TECHNICAL DOORS



AKUSTIK 32 dB door, III mechanical class, single-leaf, adjustable wooden door frame



**AKUSTIK DOOR
III MECHANICAL CLASS
ON WOODEN DOOR FRAME**



VERSION	solid 32 dB	glazed 32 dB	solid/solid 27 dB	glazed/glazed 27 dB	solid/glazed 27 dB
---------	-------------	--------------	-------------------	---------------------	--------------------

- LAMINATED CPL 0.2 mm
- UNI MAT PLUS
- LAMISTONE
- SILKSTONE
- SILKSTONE CPL
- PAINTED 9003
- MONO1 MAT
- MONO2 MAT
- MONO3 MAT
- VENEERED GROUP A
- VENEERED GROUP B
- VENEERED GROUP C, D
- SILKWOOD / REALWOOD

EXTRA CHARGES FOR NON-STANDARD DIMENSIONS

	standard width	non-standard width "100"	non-standard width "110"
standard height	-	extra charge*	extra charge*
non-standard height up to 2200 mm	extra charge*	extra charge*	extra charge*
non-standard height up to 2300 mm	extra charge*	extra charge*	extra charge*
non-standard height up to 2400 mm	extra charge*	extra charge*	extra charge*
non-standard height up to 2500 mm	extra charge*	extra charge*	extra charge*

OPTIONAL GLAZING VERSIONS



W1S W2S W3S W4S

DOOR DIMENSIONS

Fixed wooden door frame or adjustable door frame:
 Rebated system:
 Single-leaf door:
 max. width "110" – 1212 mm, max. height 2500 mm
Version 90 Plus (allows for a minimum clear opening of 900 mm when the door leaf is opened at an angle of 90°) 1032x2075 mm
 Double-leaf door:
 max. width "110+110" – 2352 mm, max. height 2500 mm

Fixed metal door frame:
 Rebated system:
 Single-leaf door:
 max. width "110" – 1204 mm, max. height 2271 mm
Version 90 Plus (allows for a minimum clear opening of 900 mm when the door leaf is opened at an angle of 90°) 1024x2071 mm
 Double-leaf door:
 max. width "110+110" – 2342 mm, max. height 2271 mm

Adjustable metal door frame:
 Rebated system:
 Single-leaf door:
 max. width "110" – 1224 mm, max. height 2281 mm
Version 90 Plus (allows for a minimum clear opening of 900 mm when the door leaf is opened at an angle of 90°) 1044x2081 mm
 Double-leaf door:
 max. width "110+110" – 2362 mm, max. height 2281 mm
 It is possible to manufacture non-standard door widths and heights after consultation with the Sales Department.

INVESTMENT WIDTH

Single-leaf door: the width of the "90 plus" door allows for a minimum clear opening of 900 mm when the door leaf is opened at an angle of 90°.

Double-leaf door: the width of the active "90 plus" door leaf allows for a minimum clear opening of 900 mm when the active door leaf is opened at an angle of 90° and the inactive door leaf is locked.

DOOR LEAF FINISH

Smooth surface painted, veneered, covered with CPL laminate 0.2 mm or 0.5 mm, HPL laminate with a thickness from 0.7 to 1.0 mm or wood-like foil.

GLAZING

Transparent glass, pine frame painted, veneered or covered with foil in a color matched to the color of the door leaf. Available porthole-type glazing with a steel frame Ø320 mm (on the outer side of the frame).

DOOR FRAMES

Painted, veneered, or laminated door frame with CPL 0.15 mm, CPL 0.2 mm or foil matched to the color range of the door leaf.

Fixed pine wooden – optionally with masking strips, quarter round.

Adjustable wooden with extension panels, angle trims and masking strip.

Fixed metal made of 1.5 mm thick steel sheet, standard powder-coated in white (RAL 9016 and RAL 9003), grey (RAL 7047), brown (RAL 8014), graphite (RAL 7024), black (RAL 9005).

Adjustable metal made of 1.5 mm thick steel sheet, standard powder-coated in white (RAL 9016 and RAL 9003), grey (RAL 7047), brown (RAL 8014), graphite (RAL 7024), black (RAL 9005). It is possible to paint door frames in non-standard colors from the RAL or NCS palette after consultation with the Sales Department. The door frame consists of a main part and an angle trim inserted into the main part.

ACCESSORIES AND EQUIPMENT

Standard equipment:
 (door with wooden or metal door frame)
 - 3 or 4 pin hinges adjustable in 3 planes by OTLAV
 - mortise lock with patent cylinder
 - drop seal

Additional equipment:
 - aluminium decors
 - decorations
 - surface or concealed door closer, panic locks, panic bars, electric strikes, electromagnetic locks, reed switch, additional lock
 Possibility to prepare milling in the door leaf for a (electronic) hotel lock after consultation with the Sales Department.

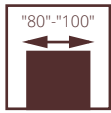

ACOUSTIC POL-SKONE

SOUNDPROOF SR 37 dB

acoustic insulation

- class $D_1 - 35$, $D_2 - 35$, class $R_w=37$ dB
- 4th class of mechanical strength according to PN-EN 1192:2001 (SR 37dB door)
- National Technical Assessment ITB-KOT-2018/0713 ed.1 (single-leaf)

SR 37 dB acoustic door, fixed wooden door frame

Door leaf in a rebated system. The structure of the door leaf consists of a **stile and rail made of softwood** covered on both sides with HDF boards. The filling consists of a special Pol-Skone construction. The nominal thickness of the door leaf is 56 mm.



SR 37 dB door, adjustable wooden door frame

SR 37 dB



VERSION solid 37 dB

- CPL LAMINATED
- UNI MAT PLUS
- LAMISTONE
- SILKSTONE
- SILKSTONE CPL 0.5 mm
- PAINTED 9003
- MONO1 MAT
- MONO2 MAT
- MONO3 MAT
- VENEERED GROUP A
- VENEERED GROUP B
- VENEERED GROUP C, D
- SILKWOOD / REALWOOD

Color range of metal door frames (p. 311)

Extra charge for CPL 0.5 mm for doors with CPL coating
(extra charge for standard door height)

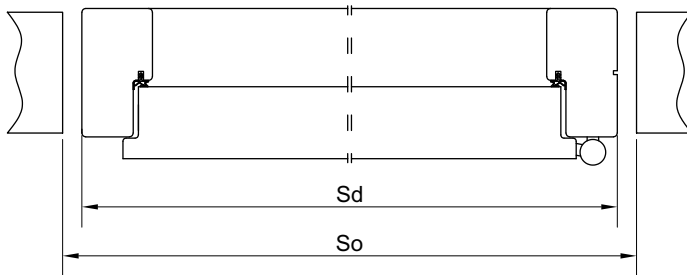

door width	Sd	So
"80"	912	940
"90"	1012	1040
"90 plus"	1032	1060
"100"	1112	1140

DOOR DIMENSIONS

Fixed or adjustable wooden door frame:
Single-leaf door:
max. width "100" - 1112 mm, max. height 2175 mm

DOOR LEAF FINISH

Smooth surface painted, veneered, covered with CPL laminate 0.2 mm or 0.5 mm, HPL laminate with a thickness from 0.7 mm to 1.0 mm, or wood-like foil.
Available flat versions, made of decorative profiled strips, aluminum decors (after consultation with the Sales Department).

DOOR FRAMES

Door frame painted, veneered, covered with CPL 0.15 mm laminate or foil matched to the color range of the door leaf.

Fixed pine wooden – optionally with masking strips, quarter round.

Adjustable wooden with extension panels, angular trims, and masking strip.

ACCESSORIES AND EQUIPMENT

Standard equipment:
single-leaf SR 37 dB:
- pin hinges adjustable in 3 planes
- mortise lock
- oak threshold in natural oak, black, grey, brown color with aluminum strip protecting against excessive wear

Additional equipment:
- aluminum decors, versions
- extra charge for CPL 0.5 mm laminate*:
 width "80"- "90";
 width "90+"- "100"
- concealed door closer
- additional mortise or surface lock
- fail-safe or fail-secure electric strike
- electromagnetic bolts
- electronic locks
- cylinders
- width "100" - 1112 mm
- height 2175 mm
- panoramic peephole - stainless steel ; brass, anthracite, black matt

* extra charge for standard door height

NEW

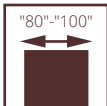

90 PLUS
INVESTMENT
WIDTH



AKUSTIK 42 dB door, fixed metal door frame

ACOUSTIC
POL-SKONE

AKUSTIK 42 dB

**AKUSTIK
SEKURO 42 dB**

- acoustic insulation class $D_1 - 35$, $D_2 - 35$, class $R_w=42$ dB
- 4th class of mechanical strength according to PN-EN 1192:2001 standard
- 5th class of mechanical durability 100,000 cycles
- door approved for sale on the basis of the PN-EN 14351-2:2018 standard

The door leaf is made of chipboard covered on both sides with HDF board. Nominal thickness of the door leaf is 57 mm. The door leaf is additionally equipped as standard with drop seals.



AKUSTIK 42 dB door, fixed metal door frame



FIXED METAL DOOR FRAME

AKUSTIK 42 dB		AKUSTIK SEKURO 42 dB	
"80", "90", "90 plus"	"100"	"80", "90"	"100"

ADJUSTABLE METAL DOOR FRAME

symbol	range in mm	AKUSTIK 42 dB		AKUSTIK SEKURO 42 dB	
		"80", "90", "90 plus"	"100"	"80", "90", "90 plus"	"100"
SR1	110-140				
SR2	140-170				
SR3	170-200				
SR4	200-230				
SR5	230-260				
SR6	260-290				
SR7	290-320				
SR8	320-350				

Color range of metal door frames (p. 311)

VERSION	AKUSTIK 42 dB	AKUSTIK SEKURO 42 dB
LAMINATED CPL 0.2 mm		
LAMINATED HPL EGGER		
GROUP B		
UNI MAT PLUS		
LAMISTONE		
SILKSTONE		
SILKSTONE CPL 0.5 mm		
PAINTED 9003		
MONO1 MAT		
MONO2 MAT		
MONO3 MAT		
VENEERED GROUP A		
VENEERED GROUP B		
VENEERED GROUP C, D		
SILKWOOD / REALWOOD		

Extra charge for CPL 0.5 mm for doors with CPL coating (extra charge for standard door height)

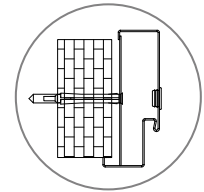
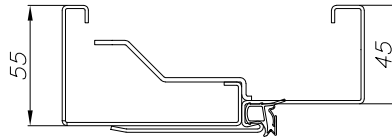
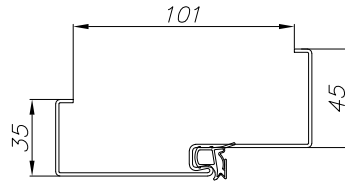

anchor mounting hole in the center of the profile on the face of the door frame

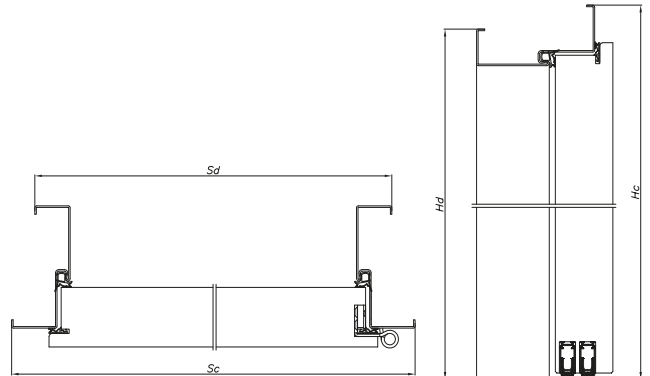
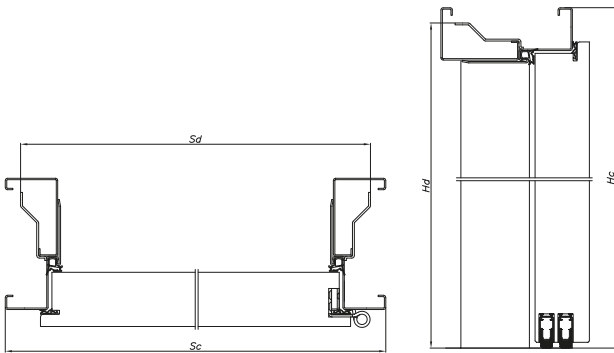

**ADJUSTABLE METAL DOOR FRAME
AKUSTIK 42 dB, AKUSTIK SEKURO 42 dB**

WIDTH	Sc	Sd	So
"80"	922	891	900
"90"	1022	991	1000
"90 plus"	1042	1011	1010
"100"	1122	1091	1100
	Hc	Hd	Ho
HEIGHT	2080	2064	2070

**FIXED METAL DOOR FRAME
AKUSTIK 42 dB, AKUSTIK SEKURO 42 dB**

WIDTH	Sc	Sd	So
"80"	922	876	895
"90"	1022	976	995
"90 plus"	1042	996	1015
"100"	1122	1076	1095
	Hc	Hd	Ho
HEIGHT	2080	2057	2067

DOOR DIMENSIONS

Doors with metal door frame:

Single-leaf door: max. width "100" - 1122 mm, max. height 2180 mm

It is possible to order a non-standard door size - after consultation with the Sales Department.

DOOR LEAF FINISH

Smooth surface painted, veneered, covered with CPL laminate with a thickness from 0.2 to 0.7 mm, HPL laminate with a thickness from 0.7 to 1.0 mm, or wood-like foil. Available designs made of decorative profiled strips.

DOOR FRAMES

Fixed or adjustable metal made of DC01 sheet metal with a thickness of 1.5 mm, powder coated in white (RAL 9016 and RAL 9003), grey (RAL 7047), brown (RAL 8014), beige (NCS S 2005 Y50R), graphite (RAL 7024), black (RAL 9005).

ACCESSORIES AND EQUIPMENT

Standard equipment for Akustik 42 dB doors:

- 3D institutional hinges by ECO SCHULTE type OBX - 2 pcs.
- mortise lock LOB
- drop seals 2 pcs.

Standard equipment for Akustik SEKURO 42 dB doors:

- 3D INSTITUTIONAL HINGES BY ECO SCHULTE TYPE OBX - 2 PCS.
- **strip mortise lock**
- drop seals - 2 pcs.
- anti-burglary bolts - 2 pcs.

Additional equipment:

- extra charge for CPL 0.5 mm laminate*:
- width "80"- "90" - ; width "90+"-"100"
- width "100" - 1112 mm
- panoramic peephole - stainless steel ; brass, anthracite, black matt
- change of hinge color to black (1 pc.)
- fail-secure and fail-safe electric strike mounted on an additional lock, hotel locks (applies to Akustik 42 dB doors)
- electromagnetic lock, reed switch, surface door closer, cylinder insert, designs, stainless steel panels, decors

* extra charge for standard door height

■ **interior entrance doors**

■ **anti-burglary doors, acoustic up to 42 dB, special**

■ **fire doors with fire resistance of 30 min and 60 min**

■ **extensive supplementary assortment**

ENTRANCE AND FIRE DOORS

Entrance and fire doors with high fire resistance and soundproofing parameters guarantee safety and comfort for people inside the building. It is possible to manufacture fire doors with a height of up to 2.5 m. Additionally, a wide range of joinery finishes including over 80 colors provides great flexibility in adapting it to individual functional and aesthetic requirements.







**HIDDEN DOOR
FOR INVESTMENT
FACILITIES
ACCORDING TO PATENT
POL-SKONE**



**TECHNICAL DOORS
AND DEDICATED TO THEM
DOOR FRAMES IN
LAMINATE
CPL 0.2 mm**



**TECHNICAL DOORS
IN VENEERS
NATURAL**



**WALL PANELS
FLAME RETARDANT
NRO**

- Wood as the main construction material for our products (wood produced in our own sawmills)
- Declared product parameters confirmed by tests in accredited laboratories
- A wide range of door leaves and door frames (painted, laminated, veneered)
- Consistent color range of interior doors, technical doors, wall panels, skirting boards, shaft doors
- Offer of two-color doors
- Possibility to personalize doors through decorative designs, aluminum decors, stainless steel panels, pictograms
- Protection of door leaf edges with ABS edging or stainless steel profiles
- Own production of metal door frames, possibility to choose color range, surface structure, possibility to order adjustable two-color door frames
- Steel or wooden thresholds, color-matched to other door elements
- Adjustable door frames for wall thickness and panel constructions / portals for investment doors
- Investment width at standard price
- Glazed fire doors and top and side lights p. fire EI30, emergency exit doors
- Acoustic parameters of doors up to 42 dB
- Wide range of hidden aluminum door frames - HARMONY; HARMONY INVEST; HARMONY INVEST PRO

What to pay attention to in case of orders for investments, i.e. hospitals, schools, offices, clinics, etc.

- 1. TYPE OF DOOR LEAF**
It is recommended to offer flat door leaves with panel construction, i.e. DECO, DECO INVEST, IMPULS, HAPTIC, INTER-AMBER, CAMBIO, etc.
- 2. APPROPRIATE SELECTION OF MECHANICAL CLASS OF DOORS**
Minimum **2nd mechanical class** according to PN-EN 1192:2001. It is recommended to offer interior doors in the 3rd mechanical class. Special reinforced construction: hinges type C, type K or three-part hinges type T, LOB lock with stainless steel faceplate.
- 3. MEETING THE REQUIREMENTS OF CLEAR OPENING**
For doors opening at a 90° angle, it is recommended to propose a width of "90 plus".
The width of the door "90 Plus" allows for a clear opening of at least 900 mm when the door leaf is opened at a 90° angle.
- 4. APPROPRIATE HINGES**
It is recommended to offer hinges:
- type T for steel door frame and DIN,
- type C for wooden door frame and type K for DIN door frame.
- 5. APPROPRIATE DOOR FRAME**
It is recommended to offer primarily steel door frames, DIN door frames, wooden (fixed and adjustable).
We do not offer fixed MDF door frames for public utility buildings.
- 6. DOOR LEAF FILLING**
It is necessary to offer filling in the form of a perforated board. Optionally, a solid board.
- 7. APPROPRIATE COATING OF DOOR LEAFS AND DOOR FRAMES**
It is recommended to offer at least LAMISTONE surface. Recommended coatings: CPL, HPL. As additional protection, suggest stainless steel panels at the handle height and at the bottom of the door leaf. Edge covers made of stainless steel.
- 8. FOR ROOMS with increased humidity, offer HIGRO doors.**
Doors intended for rooms where the permissible relative air humidity is up to 90%, and the temperature does not exceed 65°C.
Doors must not be exposed directly to water.
- 9. FOR HOSPITALS, SCHOOLS**
It is recommended to offer DECO INVEST doors and door leaves on a metal door frame as well as panels and covers made of stainless steel.
Possibility to make ABS edging with a thickness of 0.8 mm.
- 10. DOOR CLOSER**
An appropriate door closer should be selected for the type of door. In the door, reinforcement for the door closer should be used.
- 11. ROLLER LOCK**
The roller lock should always be used in combination with a door closer. The roller lock alone does not provide sufficient force for the door leaf to always remain in the closed position.

SUMMARY OF ACOUSTIC PARAMETERS FOR INDIVIDUAL TYPES OF DOORS

Name of the door	Result from the Rw test	Rw class	RA1 [dB]	RA2 [dB]	D1 class	D2 class
HARMONY INVEST	38 (-1;-2)	37	37	36	35	30
FR EI30 SR42, FR EI30 SR42 DM	43 (-1;-4)	42	42	39	40	35
RC3 wooden door frame, drop seal	33 (-1;-1)	32	32	32	30	30
B-30, C-30, SR37, B-30 INVEST	38 (0; -1)	37	38	37	35	35
RC3 wooden door frame, steel threshold	35 (-1; -1)	32	34	34	30	30
RC3, RC3 INVEST	33 (-1; -1)	32	32	32	30	30
Cerber Plus, Cerber Plus RC2 chipboard with holes, wooden door frame, drop seal	30 (0;0)	27	30	30	25	25
Cerber Plus, Cerber Plus RC2 solid chipboard, wooden door frame, drop seal	31 (0;-1)	27	31	30	25	25
Cerber Plus, Cerber Plus RC2 solid chipboard, metal door frame, drop seal	31 (-1; -1)	27	30	30	25	25
Cerber Plus, Cerber Plus RC2 chipboard POL-SKONE filling, wooden door frame, drop seal	37 (-2; -3)	37	35	34	30	30
Cerber Plus, Cerber Plus RC2 chipboard POL-SKONE filling, wooden door frame, threshold	40 (-1; -4)	37	39	36	35	30
Cerber Plus, Cerber Plus RC2 chipboard POL-SKONE filling, metal door frame, drop seal	37 (-1; -3)	37	36	34	30	30
RC3 INVEST 37 dB, RC3 INVEST SR37 EI30	37 (-1; -2)	37	36	35	30	30
AKUSTIK 42 dB, AKUSTIK SEKURO 42 dB	42 (-1;-4)	42	41	38	35	35
Soundproof type A fixed metal door frame	30 (-1;-1)	27	29	29	25	25
Soundproof type A adjustable metal door frame	30 (-1;-1)	27	29	29	25	25
Soundproof type A adjustable door frame DIN, DIN AQUA system	31 (0;-1)	27	31	30	25	25
Soundproof type A fixed door frame POL-SKONE system, adjustable POL-SKONE system	30 (-1;-1)	27	29	29	25	25
Soundproof type B fixed metal door frame	38 (-1;-2)	37	37	36	35	30
Soundproof type B adjustable metal door frame	37 (0;-1)	37	37	36	35	30
Soundproof type B adjustable door frame DIN, DIN AQUA system	37 (-1;-4)	37	36	33	30	30
Soundproof type B fixed door frame POL-SKONE system, adjustable POL-SKONE system	35 (-1;-2)	32	34	33	30	30
Soundproof type A DUO single-leaf door fixed door frame DUO system, adjustable DUO system	30 (0;-1)	27	30	29	25	25
Soundproof type A DUO double-leaf door fixed door frame DUO system, adjustable DUO system	30 (-1;-1)	27	29	29	25	25
Soundproof type B DUO single-leaf door fixed door frame DUO system, adjustable DUO system	37 (0;-2)	37	37	35	35	30
Soundproof type B DUO double-leaf door fixed door frame DUO system, adjustable DUO system	36 (-1;-2)	32	35	34	30	30
Harmony single-leaf door	30 (0;-1)	27	30	29	25	25

ACOUSTIC SUMMARY OF POL-SKONE DOORS ACCORDING TO PN-B-02151-3:2015 STANDARD

Type of building	Example of application	Requirements	Example door names
multi-family buildings	doors to apartments	$R_{s1R} \geq 30$ dB	B-30, C-30, RC3, SR37, Cerber Plus SR37, Cerber Plus RC2 SR37, RC3 INVEST, RC3 INVEST 37 dB, B-30 INVEST, RC3 INVEST SR37 EI30, SEGURO AND SEGURO PLUS
higher category hotels	doors between the hotel room and the general communication area (corridors, lobbies, staircases)	$R_{s1R} \geq 35$ dB	EI30 Pol-Skone SR42 system, Type B DUO, Harmony Invest
lower category hotels	tourist hotels, boarding houses, holiday homes	$R_{s1R} \geq 30$ dB	EI30 Pol-Skone system, EI30 Pol-Skone SR42 system, EI30 Plus, EI60 Plus, Type B, Type B DUO, Harmony Invest
collective housing buildings	student dormitories, boarding schools and school dormitories, workers' hotels, children's homes, social care homes	$R_{s1R} \geq 30$ dB	B-30, C-30, RC3, SR37, Cerber Plus SR37, Cerber Plus RC2 SR37, RC3 INVEST, Harmony Invest, B-30 INVEST, RC3 INVEST SR37 EI30, RC3 INVEST SR37
hospitals	doctor's offices	$R_{s1R} \geq 35$ dB	EI30 Pol-Skone SR42 system, Type B DUO, Harmony Invest
	doctors' and nurses' rooms	$R_{s1R} \geq 30$ dB	EI30 Pol-Skone system, EI30 Pol-Skone SR42 system, EI30 Plus, EI60 Plus, Type B, Type B DUO, Harmony Invest

SUMMARY OF POL-SKONE ANTI-BURGLARY DOORS

Type of building	Burglary resistance	Name of the door
multi-family buildings – doors to apartments	RC2 class (according to PN-EN 1627:2012)	Cerber Plus RC2
	RC3 class (according to PN-EN 1627:2012)	B-30, C-30, RC3, RC3 INVEST
	Class C (according to PN-B-92270:1990)	C-30
	RC3 class (according to PN-EN 1627:2021)	RC3 INVEST SR37, RC3 INVEST SR37 EI30, B-30 INVEST



B-30 door, version W00, single-sided adjustable door frame

ANTI-BURGLARY POL-SKONE B-30/C-30

Burglary resistance
 POL-SKONE B-30
 - class RC3 according to PN-EN 1627:2012
 POL-SKONE C-30
 - class RC3 according to PN-EN 1627:2012
 - class C according to PN-B-92270:1990
 Smoke tightness - class Sa, S₂₀₀
 Fire resistance - class EI₃₀
 Acoustic insulation - D1-35, D2-35, Rw=37 dB
 4th class of mechanical strength according to PN-EN 1192:2001
 National Technical Assessment ITB
 - KOT-2018/0713 edition 2
 National Certificate of Performance Consistency
 No. 020-UWB-2728/W

ATTENTION! In order to meet fire resistance requirements, the door must be equipped with a door closer compliant with PN-EN 1154:1999/A1:2004/AC:2010, door handles compliant with PN-EN 1906:2012 (minimum class B for fire resistance and minimum class 3 for burglary resistance), and cylinder inserts compliant with PN-EN 1303:2015 (minimum class 4 for key-related resistance, minimum class 1 for attack resistance, and class B for fire resistance).

Interior entrance doors from corridors or staircases to, for example, apartments in multi-family buildings or rooms in public utility buildings.

The door leaf constructed of a wooden stile and rail covered with two HDF boards. The infill consists of a special POL-SKONE construction. The thickness of the door leaf is 56 mm.



B-30 door, version W00, fixed wooden door frame



B-30



C-30



**ADJUSTABLE DOOR FRAME
FOR ENTRANCE DOORS**
- p. 268

VERSION	W00
LAMISTONE CPL	
UNI MAT PLUS	
SILKSTONE	
SILKSTONE CPL 0.5 mm	
LAMINATED CPL 0.2 mm	
LAMINATED HPL EGGER GROUP A	
LAMINATED HPL EGGER GROUP B	
PAINTED 9003*	
MONO1 MAT	
MONO2 MAT	
MONO3 MAT	
VENEERED GROUP A	
VENEERED GROUP B	
VENEERED GROUP C, D	
SILKWOOD / REALWOOD	

VERSION	W00
LAMISTONE CPL	
UNI MAT PLUS	
SILKSTONE	
SILKSTONE CPL 0.5 mm	
LAMINATED CPL 0.2 mm	
LAMINATED HPL EGGER GROUP A	
LAMINATED HPL EGGER GROUP B	
PAINTED 9003*	
MONO1 MAT	
MONO2 MAT	
MONO3 MAT	
VENEERED GROUP A	
VENEERED GROUP B	
VENEERED GROUP C, D	
SILKWOOD / REALWOOD	

*standard color of door leafs and wooden door frames – white RAL 9003.

Extra charge for CPL 0.5 mm for doors with CPL coating
(extra charge for standard door height)



strip (visible after closing the door)



strip lock



strip lock



hinge



anti-burglary bolts



oak threshold also available in other colors – p. 285

DOOR DIMENSIONS

Fixed or adjustable wooden door frame:

standard: 1012x2075 mm
optionally: 980x2075 mm, 880x2075 mm, 1012x2000 mm,
980x2000 mm, 880x2000 mm, 1012x1950 mm, 980x1950 mm,
880x1950 mm
max. width 1112 mm, max. height 2175 mm

ATTENTION! C-30 doors with width above 1012 mm or height above 2075 mm do not have the smoke tightness parameter

INVESTMENT WIDTH!

Width 90 Plus – 1032x2075 mm.

The door width of 1032 mm allows for a clear opening of at least 900 mm when the door leaf is opened at an angle of 90°.

DOOR LEAF FINISH

Smooth surface painted, veneered, covered with CPL laminate 0.2 mm or 0.5 mm, HPL laminate with thickness from 0.7 mm to 1.0 mm, or wood-like foil.
Available flat versions, made of decorative profiled strips, aluminum decors (after consultation with the Sales Department).

DOOR FRAMES

Painted, veneered, CPL laminated (0.15 mm, 0.2 mm) or foil-coated door frame matched to the color range of the door leaf.
Fixed pine wooden – optionally with masking strips, quarter round.

Adjustable wooden with extension panels, angle trims, and masking strip. Optionally: side trim with a width of 210 mm and thickness of 16 mm (vertical elements) – p. 268

ACCESSORIES AND EQUIPMENT

Standard equipment of B-30 doors:

- pivot hinges adjustable in 3 planes by OTLAV
- strip lock by LOB with four-point locking (2 bolts, 2 hooks) for cylinder insert with 72 mm spacing
- anti-burglary bolts (silver or black) – 5 pcs.
- oak threshold in natural oak, black, grey, or brown color with an aluminum strip protecting against excessive wear

Standard equipment of C-30 doors:

- pivot hinges adjustable in 3 planes by OTLAV
- strip lock by LOB with five-point locking (2 bolts, 3 hooks) for cylinder insert with 72 mm spacing
- set of class 6 inserts
- handle and upper escutcheon GARDA / ATLAS with cylinder protection – inox color
- anti-burglary bolts (silver or black) – 5 pcs.
- oak threshold in natural oak, black, grey, or brown color with an aluminum strip protecting against excessive wear

Additional equipment for B-30:

- aluminum decors, decorations, surface or concealed door closer, DORMAKABA electromagnetic lock, reed switch
- handles, escutcheons, inserts for entrance doors – p. 295
- width 1112 mm
- height 2175 mm
- panoramic peephole - stainless steel ; brass, anthracite, black matt

Additional equipment C-30:

- decorative elements, surface-mounted or concealed door closer, DORMAKABA electromagnetic lock, reed switch,
- aluminum decors, new versions – p. 291
- handles, escutcheons, inserts for entrance doors – p. 295
- width 1112 mm
- height 2175 mm
- change of standard oak threshold color to black, gray, brown - without extra charge (p. 285)
- change of edge color to gray, graphite, black
- panoramic peephole - stainless steel; brass, anthracite, black matt

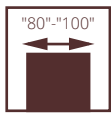

ANTI-BURGLARY POL-SKONE B-30 INVEST

Burglary resistance
POL-SKONE B-30 – class RC3 according
to PN-EN 1627:2021
Smoke tightness – class Sa, S₂₀₀
Fire resistance – class EI₃₀
Acoustic insulation – D1-35, D2-35, Rw=37 dB
4th class of mechanical strength according
to PN-EN 1192:2001

Interior entrance doors from corridors or staircases to, for example, apartments in multi-family buildings or rooms in public utility buildings. Manufactured in accordance with PN-EN 14351-2:2018, PN EN 16034:2014-11. Doors opening into the room. The door leaf is constructed of a wooden stile and rail covered with two HDF boards. The infill consists of a special POL-SKONE construction. The thickness of the door leaf is 57 mm.

B-30 INVEST door, version W00, single-sided adjustable door frame

ENTRANCE AND FIRE-RESISTANT DOORS



B-30 INVEST door, version W00, fixed wooden door frame



B-30 INVEST



VERSION W00

- LAMINATED CPL 0.2mm
- LAMINATED HPL EGGER GROUP A
- LAMINATED HPL EGGER GROUP B
- UNI MAT PLUS
- LAMISTONE
- SILKSTONE
- SILKSTONE CPL 0.5mm
- PAINTED RAL 9003
- MONO1 MAT
- MONO2 MAT
- MONO3 MAT
- VENEERED GROUP A
- VENEERED GROUP B
- VENEERED GROUP C, D
- SILKWOOD / REALWOOD



oak threshold also available in other colors - p. 285

*standard color of door leaves and wooden door frames - white RAL 9003

Extra charge for CPL 0.5 mm for doors with CPL coating (extra charge for standard door height)



strip lock



upper rosette



hinge



anti-burglary bolts



strip lock

DOOR DIMENSIONS

Fixed or adjustable wooden door frame:
 standard: 1012x2075 mm
 optionally: 980x2075 mm, 880x2075 mm, 1012x2000 mm,
 980x2000 mm, 880x2000 mm, 1012x1950 mm, 980x1950 mm,
 880x1950 mm
 max. width 1112 mm, max. height 2175 mm

INVESTMENT WIDTH!
Width 90 Plus - 1032x2075 mm.
The door width of 1032 mm allows for a clear opening of at least 900 mm when the door leaf is opened at an angle of 90°.

DOOR LEAF FINISH

Smooth surface painted, veneered, covered with CPL laminate with a thickness from 0.2 to 0.5 mm, HPL laminate with a thickness from 0.7 to 1.0 mm, or wood-like foil.
 Available flat versions, made of decorative profiled strips, aluminum decors (after consultation with the Sales Department).

DOOR FRAMES

Painted, veneered, CPL laminated (0.15 mm, 0.2 mm) or foil-coated door frame matched to the color range of the door leaf.
Fixed pine wooden - optionally with masking strips, quarter round.

Adjustable wooden with extension panels, angle trims, and masking strip. Optionally: side trim with a width of 210 mm and thickness of 16 mm (vertical elements) - p. 297

ACCESSORIES AND EQUIPMENT

Standard equipment:
 - 3D institutional hinges by ECO SCHULTE type OBX - 2 pcs.
 - FUHR strip lock with four-point locking (2 bolts, 2 hooks) for a cylinder insert with 92 mm spacing
 - anti-burglary bolts (silver or black) - 4 pcs.
 - oak threshold in natural oak, black, grey, brown color with aluminum strip protecting against excessive wear

Additional equipment for B-30:
 - decorative elements, surface-mounted or concealed door closer, DORMAKABA electromagnetic lock, reed switch
 - handles, escutcheons, inserts for entrance doors - p. 295
 - width 1112 mm
 - height 2175 mm
 - panoramic peephole - stainless steel ; brass, anthracite, black matt



RC3 INVEST SR 37 EI30 door, version W0, fixed metal door frame

ANTI-BURGLARY POL-SKONE

RC3 INVEST SR 37 EI30

- Burglary resistance class RC3 according to PN-EN 1627:2021
- Fire resistance class EI₂30
- Acoustic insulation $R_w = 37$ dB, D1-30, D2-30
- Mechanical strength class 4 according to PN-EN 1192:2001
- Smoke tightness – class S₉, S₂₀₀
- Durability: class 5 according to PN-EN 16034:2014-11 (200,000 cycles)

Interior entrance doors from corridors or staircases to, for example, apartments in multi-family buildings or rooms in public utility buildings. Manufactured in accordance with PN-EN 14351-2:2018, PN EN 16034:2014-11.

Doors opening into the room.

The door leaf is constructed of a **wooden stile and rail and special acoustic filling**. The entire structure is covered on both sides with a set of HDF boards.



RC3 INVEST SR 37 EI30 door, version W0, fixed metal door frame

RC3 INVEST SR 37 EI30



VERSION

LAMINATED CPL 0.2 mm
LAMINATED HPL EGGER GROUP A
LAMINATED HPL EGGER GROUP B
UNI MAT PLUS
LAMISTONE
SILKSTONE
SILKSTONE CPL 0.5 mm
PAINTED 9003
MONO1 MAT
MONO2 MAT
MONO3 MAT
VENEERED GROUP A
VENEERED GROUP B
VENEERED GROUP C, D
SILKWOOD / REALWOOD

Extra charge for the color range of metal door frames (p. 311)



stainless steel threshold



RC3 INVEST SR 37 EI30 hinge

DOOR DIMENSIONS

Fixed metal door frame:
920x2080 mm, 1020x2080 mm, max. door width "100" 1120 mm,
max. height 2180 mm

INVESTMENT WIDTH
Width 90 Plus - 1040 mm. Door width of 1040 mm allows for a minimum clear opening of 900 mm when the door leaf is opened at an angle of 90°.

DOOR LEAF FINISH

Smooth surface painted, veneered, covered with CPL laminate 0.2 mm or 0.5 mm, HPL laminate with thickness from 0.7 mm to 1.0 mm, or wood-like foil.
Available flat versions, made of decorative profiled strips, aluminum decors (after consultation with the Sales Department).

DOOR FRAMES

Fixed metal made of 1.5 mm thick steel sheet, powder-coated as standard in white (RAL 9016 and RAL 9003), gray (RAL 7047), brown (RAL 8014), beige (NCS S 2005 Y50R), graphite (RAL 7024), black (RAL 9005).

It is possible to paint door frames in non-standard colors from the RAL or NCS palette after consultation with the Sales Department.

ACCESSORIES AND EQUIPMENT

Standard equipment:
- fixed steel door frame 1.5 mm thick with rebate gasket
- strip lock with four-point locking
- 3D adjustable object hinges – 2 pcs.
- anti-burglary bolts (silver or black) – 4 pcs.
- steel threshold with rebate gasket
- intumescent seals

Additional equipment:
- handles, escutcheons, inserts for entrance doors – p. 295
- change of hinge color to black (1 pc.)
- panoramic peephole
- surface-mounted door closer, arm, rail or concealed type



RC3 INVEST 37 dB door, version W0, fixed metal door frame

ANTI-BURGLARY POL-SKONE RC3 INVEST 37 dB

- Burglary resistance class RC3 according to PN-EN 1627:2021
- Acoustic insulation – D1-30, D2-30, $R_w=37$ dB
- 4th class of mechanical strength according to PN-EN 1192:2001
- Mechanical durability: class 5 according to PN-EN 12400:2004
- Manufactured in accordance with PN-EN 14351-2:2018

ATTENTION! In order for the door to meet anti-burglary parameters, door handles should comply with the requirements of PN-EN 1906:2012 (minimum class 3 burglary resistance), and cylinder inserts should comply with the requirements of PN-EN 1303:2015 (minimum class 4 key-related resistance and minimum class 1 attack resistance).

Interior entrance doors from corridors or stairwells of stairwells to, for example, apartments in multi-family buildings or rooms in public utility buildings.

The door leaf is constructed from a wooden stile and rail, covered with two HDF boards. The infill consists of a special POL-SKONE construction. Door leaf thickness 57 mm.

ENTRANCE AND FIRE-RESISTANT DOORS



RC3 INVEST 37 dB door, version W0, fixed metal door frame

RC3 INVEST SR 37 dB



RC3 INVEST 37 dB door with metal door frame

FIXED METAL DOOR FRAME RC3 INVEST SR 37 dB

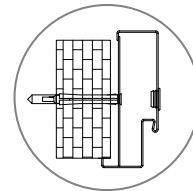
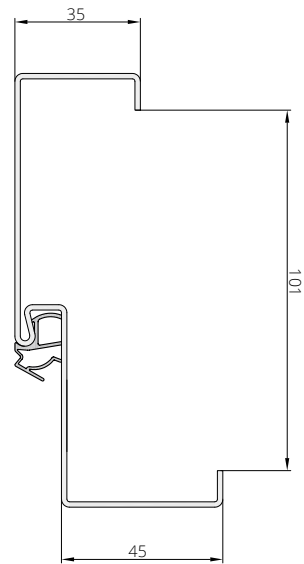

anchor mounting hole in the center of the profile for the face of the door frame

VERSION

LAMINATED CPL 0.2 mm
LAMINATED HPL EGGER GROUP A
LAMINATED HPL EGGER GROUP B
UNI MAT PLUS
LAMISTONE
SILKSTONE
SILKSTONE CPL 0.5 mm
PAINTED 9003
MONO1 MAT
MONO2 MAT
MONO3 MAT
VENEERED GROUP A
VENEERED GROUP B
VENEERED GROUP C, D
SILKWOOD / REALWOOD

Extra charge for the color range of metal door frames (p. 311)

Extra charge for CPL 0.5 mm for doors with CPL coating
(extra charge for standard door height)



stainless steel threshold



RC3 INVEST 37 dB hinge

DOOR DIMENSIONS

Fixed metal door frame:
920x2080 mm, 1020x2080 mm,
max. door width "100" 1120 mm, max. height 2180 mm

INVESTMENT WIDTH

Width 90 Plus - 1040 mm. Door width of 1040 mm allows for a minimum clear opening of 900 mm when the door leaf is opened at an angle of 90°.

DOOR LEAF FINISH

Smooth surface painted, veneered, covered with CPL laminate with a thickness from 0.2 to 0.7 mm, HPL laminate with a thickness from 0.7 to 1.0 mm, or wood-like foil.
Available flat versions, made of decorative profiled strips, aluminum decors (after consultation with the Sales Department).

DOOR FRAMES

Fixed metal made of 1.5 mm thick steel sheet, powder-coated as standard in white (RAL 9016 and RAL 9003), gray (RAL 7047), brown (RAL 8014), beige (NCS S 2005 Y50R), graphite (RAL 7024), black (RAL 9005).

It is possible to paint door frames in non-standard colors from the RAL or NCS palette after consultation with the Sales Department.

ACCESSORIES AND EQUIPMENT

Standard equipment RC3 INVEST 37 dB:
- RC3 INVEST metal door frame
- stainless steel threshold with rebate gasket
- anti-burglary bolts (silver or black) - 4 pcs.
- 3D adjustable object hinges - 2 pcs.
- mortise strip lock with four-point locking (2 bolts, 2 hooks), spacing 92 mm, silver color

Additional equipment:

- extra charge for CPL 0.5 mm laminate*:
width "80"- "90" - ; width "90+", "100"
- decorations, surface-mounted door closer, DORMAKABA electromagnetic lock, reed switch - pp. 279-285
- handles, escutcheons, inserts for entrance doors - p. 295
- door width "100"
- door higher by 100 mm
- change of edge color to gray, graphite, black
- change of hinge color to black (1 pc.)
- panoramic peephole - stainless steel ; brass, anthracite, black matt

* extra charge for standard door height

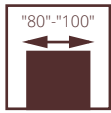

RC3 door, version W0, fixed wooden door frame

ANTI-BURGLARY POL-SKONE

RC3

RC3 INVEST

- Burglary resistance class RC3 according to PN-EN 1627:2012
- Acoustic insulation – D1-30, D2-30, Rw=32 dB
- 4th class of mechanical strength according to PN-EN 1192:2001
- National Technical Assessment ITB –KOT-2018/0713 edition 2

ATTENTION! In order for the door to meet anti-burglary parameters, door handles should comply with the requirements of PN-EN 1906:2012 (minimum class 3 burglary resistance), and cylinder inserts complying with the requirements of PN-EN 1303:2015 (minimum class 4 key-related resistance and minimum class 1 attack resistance).

Interior entrance doors from corridors or stairwells of stairwells to, for example, apartments in multi-family buildings or rooms in public utility buildings.

The door leaf is constructed from a wooden stile and rail, covered with two HDF boards. The infill consists of a special POL-SKONE construction. Door leaf thickness 50 mm.

ENTRANCE AND FIRE-RESISTANT DOORS



RC3 door, version W0, fixed wooden door frame



RC3 INVEST door, version W0, fixed metal door frame

RC3



RC3 door with wooden door frame

RC3 INVEST



RC3 INVEST door with metal door frame

ADJUSTABLE DOOR FRAME FOR ENTRANCE DOORS - p. 268

FIXED METAL DOOR FRAME RC3 INVEST

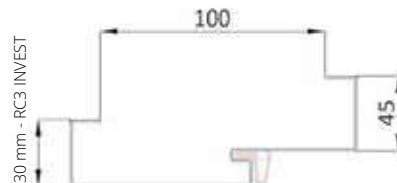

For RC3 doors with a metal door frame, it is possible to order a metal door frame with a BIRA ES 1 fail-secure electric strike (symmetrical) - p. 285

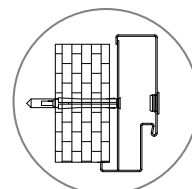

anchor mounting hole in the center of the profile for the face of the door frame

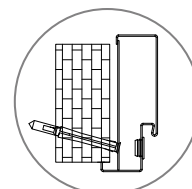

anchor mounting hole in the rebate of the door frame

VERSION

- LAMINATED CPL 0.2 mm
- LAMINATED HPL EGGER GROUP A
- LAMINATED HPL EGGER GROUP B
- UNI MAT PLUS
- LAMISTONE
- SILKSTONE
- SILKSTONE CPL 0.5 mm
- PAINTED 9003
- MONO1 MAT
- MONO2 MAT
- MONO3 MAT
- VENEERED GROUP A
- VENEERED GROUP B
- VENEERED GROUP C, D
- SILKWOOD / REALWOOD

VERSION

- LAMINATED CPL 0.2 mm
- LAMINATED HPL EGGER GROUP A
- LAMINATED HPL EGGER GROUP B
- UNI MAT PLUS
- LAMISTONE
- SILKSTONE
- SILKSTONE CPL 0.5 mm
- PAINTED 9003
- MONO1 MAT
- MONO2 MAT
- MONO3 MAT
- VENEERED GROUP A
- VENEERED GROUP B
- VENEERED GROUP C, D
- SILKWOOD / REALWOOD

Extra charge for the color range of metal door frames (p. 311)

Extra charge for CPL 0.5 mm for doors with CPL coating (extra charge for standard door height)



handle



hinge

DOOR DIMENSIONS

RC3

Fixed or adjustable wooden door frame:

1012x2075 mm, 980x2075 mm, 880x2075 mm, 1012x2000 mm, 980x2000 mm, 880x2000 mm, 1012x1950 mm, 980x1950 mm, 880x1950 mm.

max. door width "100" 1112 mm, max. height 2175 mm

RC3 INVEST

Fixed metal door frame:

924x2077 mm, 1024x2077 mm

INVESTMENT WIDTH

Width 90 Plus - 1032 mm. The door width of 1032 mm allows for a clear opening of at least 900 mm when the door leaf is opened at an angle of 90°.

INVESTMENT WIDTH

Width 90 Plus - 1044 mm. The door width of 1044 mm allows for a minimum clear opening of 900 mm when the door leaf is opened at an angle of 90°.

DOOR LEAF FINISH

Smooth surface painted, veneered, covered with CPL laminate with a thickness from 0.2 to 0.7 mm, HPL laminate with a thickness from 0.7 to 1.0 mm, or wood-like foil. Available flat versions, made of decorative profiled strips, aluminum decors (after consultation with the Sales Department).

DOOR FRAMES

Painted, veneered, CPL laminated (0.15 mm, 0.2 mm) or foil-coated door frame matched to the color range of the door leaf.

Fixed pine wooden – optionally with masking strips, quarter round.

Adjustable wooden with extension panels, angular trims, and masking strip.

Optionally: side trim with a width of 210 mm and thickness of 16 mm (vertical elements) - p. 297

ACCESSORIES AND EQUIPMENT

Standard equipment RC3:

- 4 pin hinges adjustable in 3 planes by OTLAV
- FUHR strip lock with four-point locking (2 bolts, 2 hooks) for a cylinder insert with 92 mm spacing
- anti-burglary bolts – 5 pcs.
- oak threshold in natural oak, black, grey, or brown color with an aluminum strip protecting against excessive wear

Standard equipment RC3 INVEST:

- RC3 INVEST metal door frame
- stainless steel threshold
- mortise multipoint lock with four-point locking (2 bolts, 2 hooks), spacing 92 mm, silver color
- pin hinges adjustable in 3 planes in silver color - 4 pcs.
- anti-burglary bolts (silver or black) – 5 pcs.
- GARDA escutcheon in inox color
- GARDA handle (spacing 92 mm) in inox color
- set of class 6 cylinders in matt nickel color

Additional equipment:

- extra charge for CPL 0.5 mm laminate*:
 - width "80". "90" - ; width "90+", "100"
- decorations, surface or concealed door closer, DORMAKABA electromagnetic lock, reed switch - p. 279-285
- replacement of oak threshold with stainless steel threshold
- aluminum decors, new versions - p. 291
- handles, escutcheons, cylinders for entrance doors - p. 295
- door width "100" 1112 mm
- height 2175 mm
- change of standard oak threshold color to black, grey, brown without extra charge (p. 285)
- change of edge color to gray, graphite, black
- panoramic peephole - stainless steel ; brass, anthracite, black matt
- electric strikes for RC3 INVEST doors – p. 283

* extra charge for standard door height

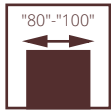

CERBER PLUS RC2 door, version 00, fixed metal door frame

ANTI-BURGLARY POL-SKONE

CERBER PLUS RC2

acoustic insulation:

class D1 – 25, D2 – 25, class Rw=27 dB (infill perforated or solid board, doors with threshold or drop seal)

class D1 – 30, D2 – 30, class Rw=37 dB (infill POL-SKONE, doors with drop seal)

class D1 – 35, D2 – 30, class Rw=37 dB (infill POL-SKONE, doors with threshold)

burglary resistance: class RC2 according to PN-EN 1627:2012

mechanical class 3 according to PN-EN 1192:2001
National Technical Assessment ITB-KOT-2019/0742
edition 1

Interior entrance doors from corridors or staircases to, for example, apartments in multi-family buildings or rooms in public utility buildings.

Doors with fixed and adjustable wooden door frame or metal door frame. The door leaf is constructed of **wooden stile and rail**, covered with two HDF boards. The infill consists of a perforated board, optionally a solid board, or a special POL-SKONE construction (version 37 dB). The nominal thickness of the door leaf is 46 mm.



CERBER PLUS RC2 door, version 00, single-sided adjustable wooden door frame

CERBER PLUS RC2



ADJUSTABLE DOOR FRAME FOR ENTRANCE DOORS
- p. 268

VERSION	solid 00	37 dB 00
	with fixed wooden door frame	with fixed metal door frame
	with fixed wooden door frame	with fixed metal door frame

UNI MAT PLUS
LAMINATED CPL 0.2 mm
LAMINATED HPL EGGER GROUP A
LAMINATED HPL EGGER GROUP B
LAMISTONE CPL
SILKSTONE
SILKSTONE CPL 0.5 mm
PAINTED 9003
MONO1 MAT
MONO2 MAT
MONO3 MAT
VENEERED GROUP A
VENEERED GROUP B
VENEERED GROUP C, D
SILKWOOD / REALWOOD

The given technical parameters refer to the set consisting of the door leaf, metal door frame, and threshold. In order to meet the requirements of the National Technical Assessment, it is necessary to purchase the entire door set, i.e. the door leaf, door frame, and threshold.

Color range of metal door frames (p. 311)

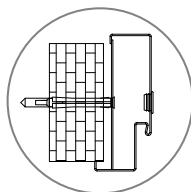

anchor mounting hole in the center of the profile for the face of the door frame

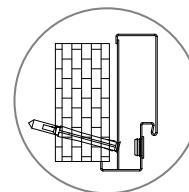

anchor mounting hole in the rebate of the door frame

Extra charge for CPL 0.5 mm for doors with CPL coating (extra charge for standard door height)

metal door frame
oak wooden threshold

DOOR PRICE = DOOR LEAF PRICE + DOOR FRAME PRICE + THRESHOLD PRICE



strip lock



strip lock



hinge



oak threshold also available in other colors - p. 285

DOOR DIMENSIONS

Door with fixed or adjustable wooden door frame:
895x2067 mm, 995x2067 mm, 895x2000 mm, 995x2000 mm, 895x1950 mm, 995x1950 mm
max. width 1095 mm, max. height 2267 mm

Door with fixed metal door frame: 917x2078 mm, 1017x2078 mm, 917x2011 mm, 1017x2011 mm, 917x1961 mm, 1017x1961 mm max. width 1117 mm, max. height 2278 mm

INVESTMENT WIDTH
Width 90 Plus - 1005x2067 mm.
Door width of 1005 mm allows for a minimum passage clearance of 900 mm when the door leaf is opened at an angle of 90°.

INVESTMENT WIDTH
Width 90 Plus - 1027x2078 mm.
Door width of 1027 mm allows for a minimum passage clearance of 900 mm when the door leaf is opened at an angle of 90°.

DOOR LEAF FINISH

Smooth surface painted, veneered, covered with CPL laminate with a thickness from 0.2 to 0.7 mm, HPL laminate with a thickness from 0.7 to 1.0 mm, or wood-like foil.

Available flat designs, made of decorative profiled strips, aluminum decors.

DOOR FRAMES

Painted, veneered, CPL laminated (0.15 mm, 0.2 mm) or foil-coated door frame matched to the color range of the door leaf.

Fixed pine wooden – optionally with masking strips, quarter round.

Adjustable wooden with extension panels, angular trims, and masking strip.

Fixed metal made of 1.5 mm thick sheet metal, powder-coated in white (RAL 9016 and RAL 9003), gray (RAL 7047), brown (RAL 8014), beige (NCS S 2005 Y50R), graphite (RAL 7024), black (RAL 9005). It is possible to paint door frames in non-standard colors from the RAL or NCS palette after consultation with the Sales Department.

ACCESSORIES AND EQUIPMENT

Standard equipment:

- Door with wooden door frame (fixed or adjustable)
- adjustable screw-in pin hinges – 3 pcs.
- strip lock with four-point locking
- strike plates, adjustable, reinforced (not applicable to doors with metal door frame)
- anti-burglary bolts (silver or black) – 3 pcs.
- peephole Ø15
- oak threshold in natural oak, black, gray, brown color with aluminum strip protecting against excessive wear (for wooden door frame)
- oak threshold (applies to metal door frame)

Additional equipment:

- solid board filling
- aluminum decors - p. 291
- set of inserts minimum class 4
- handles and escutcheons minimum class 2
- drop seal (without threshold)
- designs - p. 291

- hinge covers (1 pc.):
white/brown - , chrome/matt nickel
- replacement of oak threshold with stainless steel threshold (applies to metal door frame)
- handles, escutcheons, inserts for entrance doors – p. 295
- width 1095 mm (wooden door frame)
- width 1117 mm (metal door frame)
- height 2167 mm (wooden door frame)
- height 2178 mm (metal door frame)
- height 1950 mm (wooden door frame)
- height 1961 mm, 2011 mm (metal door frame)
- height 2267 mm (wooden door frame)
- height 2278 mm (metal door frame)
- change of edge color to gray, graphite, black
- panoramic peephole - stainless steel; brass, anthracite, black matt

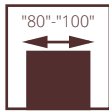

CERBER PLUS door, version 00, fixed wooden door frame

INTERIOR ENTRANCE CERBER PLUS

acoustic insulation:
class D1 – 25, D2 – 25, class $R_w=27$ dB (infill perforated or solid board, doors with threshold or drop seal)
class D1 – 30, D2 – 30, class $R_w=37$ dB (infill POL-SKONE, doors with drop seal)
class D1 – 35, D2 – 30, class $R_w=37$ dB (infill POL-SKONE, doors with threshold)
3rd mechanical class according to PN-EN 1192:2001 standard
National Technical Assessment ITB-KOT-2019/0742 edition 1

Door with wooden or metal door frame. The door leaf is constructed of **wooden stile and rail**, covered with two HDF boards. The filling consists of a perforated board, optionally a solid board or a special POL-SKONE construction (version 37 dB). Nominal thickness of the door leaf is 46 mm.

ENTRANCE AND FIRE-RESISTANT DOORS



CERBER PLUS door, version 00, single-sided adjustable wooden door frame

CERBER PLUS



ADJUSTABLE DOOR FRAME FOR ENTRANCE DOORS
- p. 268

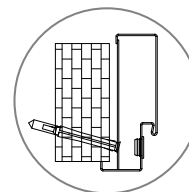
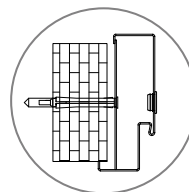

anchor mounting hole in the center of the profile for the face of the door frame

anchor mounting hole in the rebate of the door frame

VERSION	solid 00	37 dB 00
	with fixed wooden door frame	with door frame fixed metal
	with fixed wooden door frame	with door frame fixed metal

- UNI MAT PLUS
- LAMINATED CPL 0.2 mm
- LAMINATED HPL EGGER GROUP A
- LAMINATED HPL EGGER GROUP B
- LAMISTONE CPL
- SILKSTONE
- SILKSTONE CPL 0.5 mm
- PAINTED 9003
- MONO1 MAT
- MONO2 MAT
- MONO3 MAT
- VENEERED GROUP A
- VENEERED GROUP B
- VENEERED GROUP C, D
- SILKWOOD / REALWOOD

Color range of metal door frames (p. 311)

Extra charge for CPL 0.5 mm for doors with CPL coating (extra charge for standard door height)

The given technical parameters refer to the set consisting of the door leaf, metal door frame, and threshold. In order to meet the requirements of the National Technical Assessment, it is necessary to purchase the complete set of doors, i.e. door leaf, door frame, and threshold.

- metal door frame
- oak wooden threshold



handle



upper rosette



upper rosette



oak threshold also available in other colors - p. 285

DOOR DIMENSIONS

Door with fixed or adjustable wooden door frame:
855x2067 mm, 895x2067 mm, 995x2067 mm, 895x2000 mm, 995x2000 mm 895x1950 mm, 995x1950 mm
max. door width "100" - 1095 mm, max. height 2267 mm

Door with fixed metal door frame:
917x2078 mm, 1017x2078 mm, 917x2011 mm, 1017x2011 mm, 917x1961 mm, 1017x1961 mm max. door width "100" - 1117 mm, max. height 2278 mm

INVESTMENT WIDTH
Width 90 Plus - 1005 mm.
Door width of 1005 mm allows for a minimum passage clearance of 900 mm when the door leaf is opened at an angle of 90°.

INVESTMENT WIDTH ATTENTION!
Width 90 Plus - 1027 mm.
The width of the door 1027 mm allows for a minimum passage clearance of 900 mm when the door leaf is opened at an angle of 90°.

DOOR LEAF FINISH

Smooth surface painted, veneered, covered with CPL laminate with a thickness from 0.2 to 0.7 mm, HPL laminate with a thickness from 0.7 to 1.0 mm, or wood-like foil. Available flat designs, made of decorative profiled strips, aluminum decors.

DOOR FRAMES

Painted, veneered, CPL laminated (0.15 mm, 0.2 mm) or foil-coated door frame matched to the color range of the door leaf.
Fixed pine wooden - optionally with masking strips, quarter round.
Adjustable wooden with extension panels, angular trims, and masking strip.

Fixed metal made of 1.5 mm thick sheet metal, powder coated in white (RAL 9016 and RAL 9003), grey (RAL 7047), brown (RAL 8014), beige (NCS S 2005 Y50R), graphite (RAL 7024), black (RAL 9005).

It is possible to paint door frames in non-standard colors from the RAL or NCS palette after consultation with the Sales Department.

ACCESSORIES AND EQUIPMENT

Standard equipment:
Door with wooden door frame
- pivot hinges adjustable in 3 planes by OTLAV - 3 pcs.
- two independent three-bolt locks for a patent cylinder
- anti-burglary bolts (silver or black) - 2 pcs.
- peephole Ø15
- oak threshold in natural oak, black, grey, brown color with aluminum strip protecting against excessive wear
- reinforced strike plates for locks
Door with metal door frame
- pivot hinges adjustable in 3 planes by OTLAV - 3 pcs.
- two independent three-bolt locks for a patent cylinder
- anti-burglary bolts (silver or black) - 2 pcs.
- peephole Ø15
- oak threshold in natural oak, black, grey, brown color

Additional equipment:
- solid board filling
- hinge with closing function (only for wooden door frame)
- drop seal (without threshold)
- hinge covers (1 pc.): white/brown, chrome/matt nickel
- replacement of oak threshold with stainless steel threshold (applies to metal door frame)
- aluminum decors, new versions - p. 291
- handles, escutcheons, inserts for entrance doors - p. 295
- width 1095 mm (wooden door frame)
- height 2167 mm (wooden door frame)
- height 2267 mm (wooden door frame)
- width 1117 mm (metal door frame)
- height 2178 mm (metal door frame)
- height 2278 mm (metal door frame)
- height 1950 mm, 2000 mm (wooden door frame)
- change of edge color to gray, graphite, black
- panoramic peephole - stainless steel ; brass, anthracite, black matt
- designs - p. 291

NEW

rebated SYSTEM

"80"-"100 PLUS"

POL-SKONE

90 PLUS INVESTMENT WIDTH



INTERIOR ENTRANCE

SEGURO SEGURO PLUS

Acoustic insulation:

- oak threshold - $R_w = 40$ dB
- class $R_w - 37$ dB, $R_{a1} - 40$ dB, $R_{a2} - 37$ dB
- Drop seal - $R_w = 41$ dB
- class $R_w - 37$ dB, $R_{a1} - 40$ dB, $R_{a2} - 37$ dB
- Air permeability - class C

Interior entrance doors from corridors or staircases to, for example, apartments in multi-family buildings or rooms in public utility buildings. Manufactured in accordance with the PN-EN 14351-2:2018 standard. The door opens inward into the room.

The door leaf is constructed from a pine wood frame and acoustic filling. The frame with filling is covered on both sides with a set of HDF boards. Nominal thickness of the door leaf is 46 mm.

SEGURO door, version VD9, fixed wooden door frame

FIXED DOOR FRAME

HEIGHT (mm)

H_d	H_o	H_s	Module
2069	2080	2022	Standard
2019	2030	1972	-50 mm
2119	2130	2072	+50 mm
2169	2180	2122	+100 mm
2219	2230	2172	+150 mm
2269	2280	2222	+200 mm

WIDTH (mm)

type	S_d	S_o	S_s
"80 Plus"	905	935	828
"90 plus"	1005	1035	928
"100 Plus"	1105	1135	1028

ADJUSTABLE DOOR FRAME

HEIGHT (mm)

H_{op}	H_d	H_o	H_s	Module
2115	2048	2060	2022	Standard
2065	1998	2010	1972	-50 mm
2165	2098	2110	2072	+50 mm
2215	2148	2160	2122	+100 mm
2265	2198	2210	2172	+150 mm
2315	2248	2260	2222	+200 mm

WIDTH (mm)

type	S_{op}	S_d	S_o	S_s
"75"	946	812	855	778
"80 Plus"	996	862	905	828
"85"	1046	912	955	878
"90 plus"	1096	962	1005	928
"95"	1146	1012	1055	978
"100 Plus"	1196	1062	1105	1028

ENTRANCE AND FIRE-RESISTANT DOORS



SEGURO



VERSION	solid 00	
	SEGURO door leaf 37dB with a wooden threshold	door leaf SEGURO 37dB PLUS with a wooden threshold

UNI MAT PLUS
LAMISTONE CPL
SILKSTONE
LAMINATED CPL 0.2 mm
LAMINATED CPL 0.2 EGGER

EXTRA CHARGES FOR A SOLID DOOR LEAF

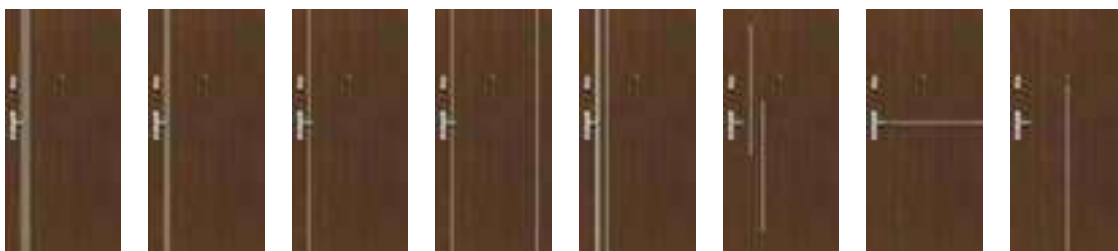

VERSION	VD11	VD12	VD13	VD14	VD9	VD3	VD7	VD8
---------	------	------	------	------	-----	-----	-----	-----

ALU silver decors
ALU black decors

fixed wooden door frame
SEGURO 37dB

fixed wooden door frame
SEGURO 37dB PLUS

UNI MAT PLUS
LAMISTONE CPL
SILKSTONE
LAMINATED CPL 0.2 mm
LAMINATED CPL 0.2 EGGER

ADJUSTABLE WOODEN DOOR FRAME SEGURO 37DB

range [mm]	UNI MAT PLUS	LAMINATED CPL 0.2	LAMINATED CPL 0.2 EGGER
	LAMISTONE CPL		
	SILKSTONE		
100-120			
120-140			
140-160			
160-180			
180-200			
200-220			
220-240			
240-260			
260-280			
280-300			

ADJUSTABLE WOODEN DOOR FRAME SEGURO 37DB PLUS

range [mm]	UNI MAT PLUS	LAMINATED CPL 0.2	LAMINATED CPL 0.2 EGGER
	LAMISTONE CPL		
	SILKSTONE		
100-120			
120-140			
140-160			
160-180			
180-200			
200-220			
220-240			
240-260			
260-280			
280-300			

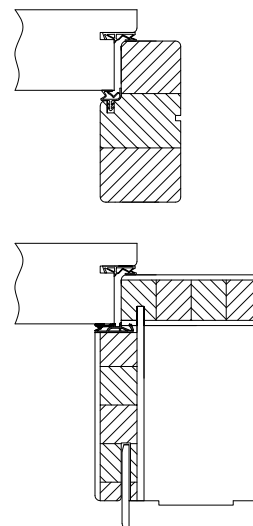

DOOR DIMENSIONS

Adjustable wooden door frame
max. width "100 PLUS" - 1062 mm, max. height - 2248 mm

Fixed wooden door frame
"100 PLUS" - 1105 mm, max. height - 2269 mm

DOOR LEAF FINISH

The surface is covered with laminate, wood-like foil, or CPL 0.2 mm laminate.

DOOR FRAMES

FIXED OR ADJUSTABLE WOODEN

Made of laminated pine wood covered on both sides with HDF board. Adjustable door frame in the range from 100 mm to 300 mm. The threshold is made of laminated oak wood, equipped with a rebate gasket and an aluminum profile. Optionally, instead of an oak threshold, a drop seal in the door leaf.

ACCESSORIES AND EQUIPMENT

Standard equipment: SEGURO

- door leaf with rebate gasket under the collar
- adjustable or fixed door frame with rebate gasket
- two mortise locks (optionally without the upper lock)
- peephole
- 3D adjustable pin hinges - 3 pcs.
- anti-burglary bolts - 2 pcs.
- oak threshold with rebate gasket

SEGURO PLUS

- door leaf with rebate gasket under the collar
- adjustable or fixed door frame with rebate gasket
- strip lock with upper lock (optionally without the upper lock)
- peephole
- 3D adjustable pin hinges - 3 pcs.
- anti-burglary bolts - 3 pcs.
- oak threshold with rebate gasket

Additional equipment:

- drop seal
- set of class 6 inserts
- handle with escutcheon and upper Atlas rosette without cylinder protection

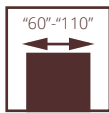

FR EI30 SR 42 door, fixed wooden door frame

FIRE-RESISTANT POL-SKONE REBATED

FR EI30 SR 42

System Pol-Skone without top and side lights

- Fire resistance EI₂₃₀ (FR EI30 SR 42 DM)
- Fire resistance EI₁₃₀ (FR EI30 SR 42)
- Smoke tightness - class S_{a1}, S₂₀₀ (FR EI30 SR 42 DM)
- Acoustic insulation class D₁ - 40, D₂ - 35, class Rw=42 dB
- 3rd class of mechanical strength according to PN-EN 1192:2001 standard
- National Technical Assessment ITB-KOT-2020/1370 ed.1
- National Certificate of Constancy of Performance No. 020-UWB-1937/W

ATTENTION! In order to meet fire resistance requirements, a door closer meeting the requirements of the PN-EN 1154:1999/A1:2004/AC:2010 standard, door handles meeting the requirements of the PN-EN 1906:2012 standard (min. class B in the area related to fire resistance), and cylinder inserts meeting the requirements of the PN-EN 1303:2015 standard (class B in the area related to fire resistance) must be used for the door.



acoustic insulation

The doors are intended for use as interior entrance doors in residential, collective housing, public utility, and industrial buildings, serving, in accordance with the terminology established in the PN-B-91000:1996 standard, as closures of openings in interior walls, between the staircase or corridor and rooms.

Door leaf in a rebated system. The structure of the door leaf consists of a **stile and rail made of softwood** covered on both sides with HDF boards. The filling consists of a special Pol-Skone construction.

ENTRANCE AND FIRE-RESISTANT DOORS

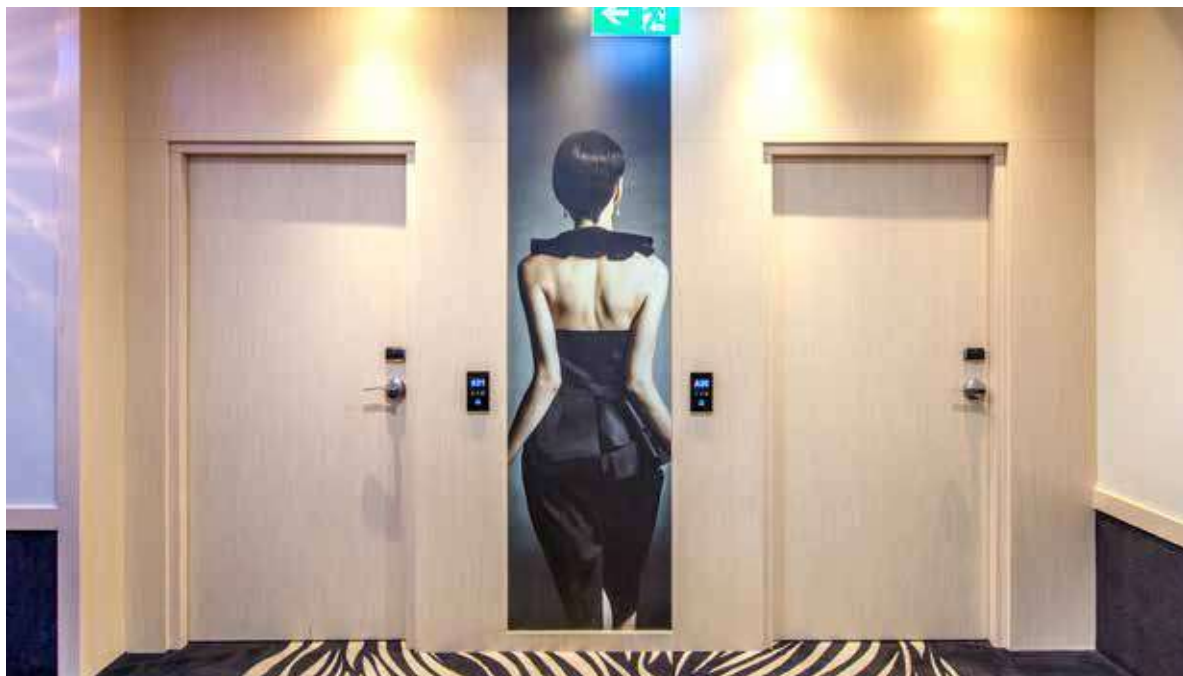

FR EI30 SR 42 fire door, fixed wooden door frame



FR EI30 SR 42



VERSION	FR EI30 SR 42	FR EI30 SR 42 DM
LAMINATED CPL 0.2 mm		
LAMINATED CPL 0.5 mm		
UNI MAT PLUS		
LAMISTONE		
SILKSTONE		
SILKSTONE CPL 0.5 mm		
PAINTED 9003		
MONO1 MAT		
MONO2 MAT		
MONO3 MAT		
VENEERED GROUP A		
VENEERED GROUP B		
VENEERED GROUP C, D		
SILKWOOD / REALWOOD		

Sample hotel locks for FR EI30 SR 42 DM door:

- Signature series or Classic series by VingCard,
- LE8P series + handle with access control XS4 series by Salto,
- LOB 5500 Adel series, LOB 8005 series, LOB 8002 series, by ASSA ABLOY Opening Solutions Poland S.A.;
- HDL MF 20 series, HDL MF 20 N series, HDL MF 65 series, by Hartmann Tresore,
- Be-Tech 6536M-65A series, Be-Tech Guardian RFID Elegant series, Be-Tech G1 series, by Guangdong BeTech Security Systems Co. LTD,
- Ilco 790 RFID series, Saflok RT series, Saflok Quantum RFID series, by Dormakaba,
- Trillium series, Advance series, by Onity

Extra charge for CPL 0.5 mm for doors with CPL coating
(extra charge for standard door height)

FR EI30 SR 42 DM DOOR ARE EQUIPPED AS STANDARD WITH SMOKE-TIGHTNESS PARAMETER S_a, S_{200}

DOOR DIMENSIONS

FR EI30 SR 42 DM door
Fixed or adjustable wooden door frame
1012x2075 mm
max. width "100" – 1112 mm, max. height 2175 mm

FR EI30 SR 42 door
Fixed or adjustable wooden door frame
1012x2075 mm
max. width "110" – 1212 mm, max. height 2275 mm

INVESTMENT WIDTH
Width 90 Plus - 1032 mm. The door width of 1032 mm allows for a clear opening of at least 900 mm when the door leaf is opened at an angle of 90°.

INVESTMENT WIDTH
Width 90 Plus - 1032 mm. The door width of 1032 mm allows for a clear opening of at least 900 mm when the door leaf is opened at an angle of 90°.

DOOR LEAF FINISH

Smooth surface painted, veneered, covered with CPL laminate with thickness from 0.2 mm to 0.7 mm, HPL laminate with thickness from 0.7 mm to 1 mm, or wood-like foil. Decorative designs made of ornamental profile strips and aluminum decors are available.

DOOR FRAMES

Door frame painted, veneered, covered with CPL laminate 0.15 mm, CPL 0.2 mm or foil matched to the color range of the door leaf.

Adjustable wooden with extension panels, angle trims, and masking strip.

Fixed pine wood - optionally with masking strips, quarter round.

ACCESSORIES AND EQUIPMENT

Standard equipment FR EI30 SR 42 DM:
- 2 OBX type object hinges by ECO SCHULTE
- mortise lock with cylinder insert
- 2 drop seals

Standard equipment FR EI30 SR 42:
- OBX type object hinges by ECO SCHULTE
- door leaf width "60"- "100" - 2 hinges
- door leaf width "110" - 3 hinges
- height 2275 mm - 3 hinges
- mortise lock with cylinder insert
- 2 drop seals

Additional equipment FR EI30 SR 42 DM:
- designs, stainless steel panels, aluminum decors
- electromechanical lock EL560/EL561
- coded mortise locks (hotel)
- surface-mounted or concealed door closer
- additional mortise locks
- change of hinge color to black (1 pc.)
- fail-secure or fail-safe electric strikes
- reed switch
- electromagnetic lock
- electromagnetic holder
- anti-panic bar with surface-mounted or mortise lock
- width "100" – 1112 mm
- height 2175 mm

Additional equipment FR EI30 SR 42:
- surface-mounted door closers - p. 281
- width "100" – 1112 mm
- width "110" – 1212 mm
- height 2175 mm
- height 2275 mm

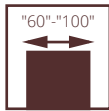

FR EI30 SR 37dB door, fixed wooden door frame

FIRE-RESISTANT POL-SKONE NON-REBATED FR EI30 SR 37dB

System Pol-Skone without top and side lights

- Fire resistance EI₂₃₀
- Acoustic insulation class D₁ - 35, D₂ - 35, class Rw=37 dB
- 3rd class of mechanical strength according to PN-EN 1192:2001 standard
- National Technical Assessment ITB-KOT-2020/1370 ed.1
- National Certificate of Constancy of Performance No. 020-UWB-1937/W

ATTENTION! In order to meet fire resistance requirements, a door closer meeting the requirements of the PN-EN 1154:1999/A1:2004/AC:2010 standard, door handles meeting the requirements of the PN-EN 1906:2012 standard (min. class B in the area related to fire resistance), and cylinder inserts meeting the requirements of the PN-EN 1303:2015 standard (class B in the area related to fire resistance) must be used for the door.



acoustic insulation

The doors are intended for use as interior entrance doors in residential, collective housing, public utility, and industrial buildings, serving, in accordance with the terminology established in the PN-B-91000:1996 standard, as closures of openings in interior walls, between the staircase or corridor and rooms.

Door leaf in a non-rebated system. The structure of the door leaf consists of a **stile and rail made of softwood** covered on both sides with HDF boards. The filling consists of a special Pol-Skone construction. The nominal thickness of the door leaf is 57 mm.



FR EI30 SR 37dB fire door, fixed wooden door frame

FR EI30 SR 37dB



VERSION FR EI30 SR 37dB

- LAMINATED CPL 0.2 mm
- LAMINATED CPL 0.5 mm
- UNI MAT PLUS
- LAMISTONE
- SILKSTONE
- SILKSTONE CPL 0.5 mm
- PAINTED 9003
- MONO1 MAT
- MONO2 MAT
- MONO3 MAT
- VENEERED GROUP A
- VENEERED GROUP B
- VENEERED GROUP C, D
- SILKWOOD / REALWOOD

Sample hotel locks for FR EI30 SR 37dB door:

- Signature series or Classic series by VingCard,
- LE8P series + handle with access control XS4 series by Salto,
- series LOB 5500 Adel, series LOB 8005, series LOB 8002, ASSA ABLOY Opening Solutions Poland S.A.,
- series HDL MF 20, series HDL MF 20 N, series HDL MF 65, Hartmann Tresore,
- Be-Tech 6536M-65A series, Be-Tech Guardian RFID Elegant series, Be-Tech G1 series, by Guangdong BeTech Security Systems Co. LTD,
- Ilco 790 RFID series, Saflok RT series, Saflok Quantum RFID series, by Dormakaba,
- series Trillium, series Advance, Onity.

Extra charge for CPL 0.5 mm for doors with CPL coating
(extra charge for standard door height)

DOOR DIMENSIONS

Fixed or adjustable wooden door frame
1012x2075 mm
single-leaf door:
width "60" - "100" - 712 - 1112 mm, max. height 2175 mm.

INVESTMENT WIDTH
90 Plus Version (allows for a minimum clear opening of 900 mm when the door leaf is opened at a 90° angle)
1072x2075 mm.

DOOR LEAF FINISH

Smooth surface painted, veneered, covered with CPL laminate with thickness from 0.2 mm to 0.7 mm, HPL laminate with thickness from 0.7 mm to 1 mm, or wood-like foil. Decorative designs made of ornamental profile strips and aluminum decors are available.

DOOR FRAMES

Painted, veneered, or laminated door frame with CPL 0.15 mm, CPL 0.2 mm or foil matched to the color range of the door leaf.

Fixed pine wood - optionally with masking strips, quarter round.
Adjustable wooden with extension panels, angle trims, and masking strip.

ACCESSORIES AND EQUIPMENT

Standard equipment FR EI30 SR 37dB:
- 3 OBX type object hinges by ECO SCHULTE
- mortise lock with cylinder insert
- 2 drop seals

Additional equipment:
- designs, stainless steel panels, aluminum decors
- electromechanical lock EL560/EL561
- coded mortise locks (hotel)
- surface-mounted or concealed door closer
- additional mortise locks
- change of hinge color to black (1 pc.)
- fail-secure or fail-safe electric strikes
- reed switch
- electromagnetic lock
- electromagnetic holder
- panic bar with surface-mounted or mortise lock
- width "100"
- height 2175 mm

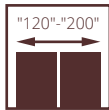
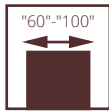

FR EI30 door, fixed wooden door frame

FIRE-RESISTANT POL-SKONE REBATED

FR EI30

System Pol-Skone
with top and side lights or without top
and side lights

- Fire resistance EI₃₀
- Acoustic insulation class D₁ – 30, D₂ – 25, class Rw=32 dB
- 3rd class of mechanical strength according to PN-EN 1192:2001 standard
- National Technical Assessment ITB-KOT-2020/1370 ed.1
- National Certificate of Constancy of Performance No. 020-UWB-1937/W

ATTENTION! In order to meet fire resistance requirements, a door closer meeting the requirements of the PN-EN 1154:1999/A1:2004/AC:2010 standard, door handles meeting the requirements of the PN-EN 1906:2012 standard (min. class B in the area related to fire resistance), and cylinder inserts meeting the requirements of the PN-EN 1303:2015 standard (class B in the area related to fire resistance) must be used for the door.

The doors are intended for use as interior entrance doors in residential, collective housing, public utility, and industrial buildings, serving, in accordance with the terminology established in the PN-B-91000:1996 standard, as closures of openings in interior walls, between the staircase or corridor and rooms.

Door leaf in a rebated system. The structure of the door leaf consists of a **stile and rail made of softwood** covered on both sides with HDF boards. The filling consists of a special Pol-Skone construction. The nominal thickness of the door leaf is 50 mm for doors with Rw = 32 dB.



FR EI30 fire door, fixed wooden door frame

FR EI30



VERSION EI30 SR 32 EI30-1S

- LAMINATED CPL 0.2 mm
- UNI MAT PLUS
- LAMISTONE
- SILKSTONE
- SILKSTONE CPL 0.5 mm
- PAINTED 9003
- MONO1 MAT
- MONO2 MAT
- MONO3 MAT
- VENEERED GROUP A
- VENEERED GROUP B
- VENEERED GROUP C, D
- SILKWOOD / REALWOOD

Sample hotel locks for FR EI30 door:

- Signature series or Classic series by VingCard,
- LE8P series + handle with access control XS4 series by Salto,
- series LOB 5500 Adel, series LOB 8005, series LOB 8002, ASSA ABLOY Opening Solutions Poland S.A.
- HDL MF 20 series, HDL MF 20 N series, HDL MF 65 series, by Hartmann Tresore,
- series Be-Tech 6536M-65A, series Be-Tech Guardian RFID Elegant, series Be-Tech G1, Guangdong BeTech Security Systems Co. LTD,
- Ilco 790 RFID series, Saflok RT series, Saflok Quantum RFID series, by Dormakaba,
- series Trillium, series Advance, Onity,

Extra charge for CPL 0.5 mm for doors with CPL coating (extra charge for standard door height)



VERSION EI 30-2 EI30-2S EI30-3S

- CPL LAMINATED
- UNI MAT PLUS
- LAMISTONE
- SILKSTONE
- SILKSTONE CPL 0.5 mm
- PAINTED 9003
- MONO1 MAT
- MONO2 MAT
- MONO3 MAT
- VENEERED GROUP A
- VENEERED GROUP B
- VENEERED GROUP C, D
- SILKWOOD / REALWOOD

SIDE AND TOP LIGHTS

- LAMINATED
- UNI MAT PLUS
- LAMISTONE
- SILKSTONE
- PAINTED 9003
- MONO1 MAT
- MONO2 MAT
- MONO3 MAT
- VENEERED A
- VENEERED B
- VENEERED C, D
- SILKWOOD / REALWOOD

price per 1 meter

Side and top lights on a fixed door frame profile 100 mm x 55 mm with EI30 fire resistance, maximum dimension of side top and side lights 944 mm x 2175 mm, maximum dimension of top top and side lights 2152 mm x 425 mm, minimum dimension of one side of the top and side light 300 mm (price per 1 meter) standard: transparent fire-resistant glass (m²):

price of top and side light = price per 1 meter x 2 (A+B) + price per 1 m² of glass x A x B

The result of acoustic tests of full single-leaf FR EI30 doors, Pol-Skone system with side top and side light is Rw(C, Ctr) = 32 (0;-1) dB.

The result of acoustic tests of glazed single-leaf FR EI30 doors, Pol-Skone system with side top and side light is Rw(C, Ctr) = 35 (0;-1) dB.

INVESTMENT WIDTH
 Single-leaf door: door width "90 plus" allows for a minimum clear opening of 900 mm when the door leaf is opened at an angle of 90°.
 Double-leaf door: the width of the active door leaf "90 plus" allows for a minimum clear opening of 900 mm with the active door leaf opened at an angle of 90° and the inactive door leaf locked.

DOOR DIMENSIONS

Fixed or adjustable wooden door frame 1012x2075 mm, max. width "100" – 1112 mm, max. height 2175 mm

INVESTMENT WIDTH
Width 90 Plus - 1032 mm. The door width of 1032 mm allows for a clear opening of at least 900 mm when the door leaf is opened at an angle of 90°.

Double-leaf door:
 "30"+"90"* (1352 mm), "40"+"90"* (1452 mm), "50"+"90"* (1552 mm), "60"+"90"* (1652 mm), "70"+"90"* (1752 mm), "80"+"90"* (1852 mm), "90"+"90"* (1952 mm);
 *door leaf with width "30", "40", "50", "60" only in the full version.
 max. width "100"+"100" – 2152 mm, max. height 2175 mm

DOOR LEAF FINISH

Smooth surface painted, veneered, covered with CPL laminate with thickness from 0.2 mm to 0.7 mm, HPL laminate with thickness from 0.7 mm to 1 mm, or wood-like foil. Decorative designs made of ornamental profile strips and aluminum decors are available.

GLAZINGS

Transparent glass with EI30 fire resistance. Oak frame painted, veneered or covered with foil in a color matched to the color of the door leaf.

DOOR FRAMES

Door frame painted, veneered, covered with CPL laminate 0.15 mm, CPL 0.2 mm or foil matched to the color range of the door leaf.
Fixed pine wood - optionally with masking strips, quarter round.

Adjustable wooden with extension panels, angle trims, and masking strip.

ACCESSORIES AND EQUIPMENT

- Standard equipment FR EI30:**
- pivot hinges adjustable in 3 planes
 - mortise lock with cylinder insert
 - drop seal
- Additional equipment:**
- designs, stainless steel panels, aluminum decors
 - electromechanical lock EL560/EL561
 - coded mortise locks (hotel)

- surface-mounted or concealed door closer
- additional mortise locks
- fail-secure or fail-safe electric strikes
- reed switch
- electromagnetic lock
- electromagnetic holder

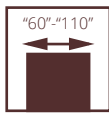

EI30 PLUS door, fixed wooden door frame

FIRE-RESISTANT POL-SKONE REBATED EI30 PLUS HALSPAN SYSTEM

- Fire resistance EI₂₃₀
- acoustic insulation
- single-leaf: class D₁ – 30, D₂ – 25, class Rw=32 dB
- double-leaf: class D₁ – 25, D₂ – 25, class Rw=27 dB
- 3rd class of mechanical strength according to PN-EN 1192:2001 standard
- Smoke tightness class S_e, S₂₀₀ (option)
- National Technical Assessment ITB-KOT-2018/0407 ed.2
- National Certificate of Constancy of Performance No. 020-UWB-2695/W

ATTENTION! In order to meet fire resistance requirements, a door closer meeting the requirements of the PN-EN 1154:1999/A1:2004/AC:2010 standard, handles for doors meeting the requirements of the PN-EN 1906:2012 standard (min. class B in the scope related to fire resistance) and cylinder inserts meeting the requirements of the PN-EN 1303:2015 standard (class B in the scope related to fire resistance).

EI30 Plus rebated fire doors of the Halspan system with a metal door frame, optionally equipped with PHA 2000 or PHA 2500 panic hardware and EXACTA 495 Ø16 mm hinges, meet the requirements of the PN-EN 1125:2009 standard regarding release capability and may be used on escape routes and emergency exits.

Door leaf in a rebated system, wooden and metal door frame (fixed or adjustable). The structure of the door leaf consists of a layered chipboard with a softwood insert, covered on both sides with HDF boards. The nominal thickness of the door leaf is 50 mm.

ENTRANCE AND FIRE-RESISTANT DOORS



EI30 PLUS double-leaf door, adjustable wooden door frame

EI30 PLUS



VERSION	solid	glazed	solid/solid	glazed/glazed	solid/glazed
---------	-------	--------	-------------	---------------	--------------

LAMINATED CPL 0.2 mm
 LAMINATED HPL EGGER GROUP A
 LAMINATED HPL EGGER GROUP B
 UNI MAT PLUS
 LAMISTONE
 SILKSTONE
 SILKSTONE CPL 0.5 mm
 PAINTED 9003
 MONO1 MAT
 MONO2 MAT
 MONO3 MAT
 VENEERED GROUP A
 VENEERED GROUP B
 VENEERED GROUP C, D
 SILKWOOD / REALWOOD

smoke tightness - extra charge: single-leaf door ; double-leaf door

door in solid version or solid/glazed version (wider door leaf glazed, narrower door leaf solid)

EXTRA CHARGES FOR NON-STANDARD DIMENSIONS OF FIRE DOORS

	standard width	non-standard width "100"	non-standard width "110"
standard height	-	extra charge*	extra charge*
non-standard height up to 2200 mm	extra charge*	extra charge*	extra charge*
non-standard height up to 2300 mm	extra charge*	extra charge*	extra charge*
non-standard height up to 2400 mm	extra charge*	extra charge*	extra charge*
non-standard height up to 2500 mm	extra charge*	extra charge*	extra charge*

*extra charge for the door (door leaf+door frame)
 Color range of metal door frames (p. 311)

OPTIONAL GLAZING VERSIONS



W1S W2S W3S W4S

DOOR LEAFS FOR DOOR FRAME METAL p. 234

METAL DOOR FRAME pp. 262-265

DOOR DIMENSIONS

Fixed wooden door frame or adjustable door frame:

Rebated system:
 Single-leaf door:
 max. width "110" – 1212 mm, max. height 2500 mm
Version 90 Plus (allows for a minimum clear opening of 900 mm when the door leaf is opened at an angle of 90°)
1032x2075 mm
 Double-leaf door:
 max. width "110+110" – 2352 mm, max. height 2500 mm

Fixed metal door frame:

Rebated system:
 Single-leaf door:
 max. width "110" – 1204 mm, max. height 2271 mm
Version 90 Plus (allows for a minimum clear opening of 900 mm when the door leaf is opened at a 90° angle)
1024x2071 mm
 Double-leaf door:
 max. width "110+110" – 2342 mm, max. height 2271 mm

Adjustable metal door frame:

Rebated system:
 Single-leaf door:
 max. width "110" – 1224 mm, max. height 2281 mm
Version 90 Plus (allows for a minimum clear opening of 900 mm when the door leaf is opened at an angle of 90°)
1044x2081 mm
 Double-leaf door:
 max. width "110+110" – 2362 mm, max. height 2281 mm

It is possible to manufacture non-standard door widths and heights after consultation with the Sales Department.

INVESTMENT WIDTH

Single-leaf door: door width "90 plus" allows for a minimum clear opening of 900 mm when the door leaf is opened at an angle of 90°. Double-leaf door: the width of the active "90 plus" door leaf allows for a minimum clear opening of 900 mm when the active door leaf is opened at an angle of 90° and the inactive door leaf is locked.

DOOR LEAF FINISH

Smooth surface painted, veneered, covered with CPL laminate with a thickness from 0.2 to 0.7 mm, HPL laminate with a thickness from 0.7 to 1.0 mm, or wood-like foil. Available flat designs, made of decorative profiled strips, aluminum decors.

GLAZING

Transparent glass with EI30 fire resistance. Pine frame painted, veneered, or covered with foil in a color matched to the color of the door leaf. Available porthole-type glazing with a steel frame Ø320 mm (on the outer side of the frame).

DOOR FRAMES

Painted, veneered, or laminated door frame with CPL 0.15 mm, CPL 0.2 mm or foil matched to the color range of the door leaf.

Fixed pine wooden – optionally with masking strips, quarter round.

Adjustable wooden with extension panels, angle trims and masking strip.

Fixed metal made of 1.5 mm thick steel sheet, standard powder-coated in white (RAL 9016 and RAL 9003), grey (RAL 7047), brown (RAL 8014), beige (NCS S 2005 Y50R), graphite (RAL 7024), black (RAL 9005).

Adjustable metal made of 1.5 mm thick steel sheet, standard powder-coated in white (RAL 9016 and RAL 9003), grey (RAL 7047), brown (RAL 8014), beige (NCS S 2005 Y50R), graphite (RAL 7024), black (RAL 9005).

It is possible to paint door frames in non-standard colors from the RAL or NCS palette after consultation with the Sales Department. The door frame consists of a main part and an angle trim inserted into the main part.

ACCESSORIES AND EQUIPMENT

Standard equipment:
 (door with wooden or metal door frame)
 - 3 or 4 pin hinges adjustable in 3 planes by OTLAV
 - mortise lock with patent cylinder
 - drop seal

Additional equipment:
 - aluminum decors - p. 291
 - designs - p. 291
 - surface-mounted or concealed door closer, panic locks, panic bars, electric strikes, electromagnetic locks, reed switch, additional lock – pp. 279-285

Possibility to prepare milling in the door leaf for a (electronic) hotel lock after consultation with the Sales Department.

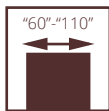

E130 PLUS door, fixed wooden door frame

FIRE-RESISTANT POL-SKONE NON-REBATED E130 PLUS HALSPAN SYSTEM

- Fire resistance EI₂30
- acoustic insulation
- single-leaf: class D₁ – 30, D₂ – 25, class Rw=32 dB
- double-leaf: class D₁ – 25, D₂ – 25, class Rw=27 dB
- 3rd class of mechanical strength according to PN-EN 1192:2001 standard
- Smoke tightness class S_a, S₂₀₀ (option)
- National Technical Assessment ITB-KOT-2018/0407 ed.2
- National Certificate of Constancy of Performance No. 020-UWB-2695/W

ATTENTION! In order to meet fire resistance requirements, a door closer meeting the requirements of the PN-EN 1154:1999/A1:2004/AC:2010 standard, handles for doors meeting the requirements of the PN-EN 1906:2012 standard (min. class B in the scope related to fire resistance) and cylinder inserts meeting the requirements of the standard PN-EN 1303:2015 (class B in the scope related to fire resistance).

Door leaf in a non-rebated system, wooden and metal door frame (fixed or adjustable). The structure of the door leaf consists of a layered chipboard with a softwood insert, covered on both sides with HDF boards. The nominal thickness of the door leaf is 50 mm.



E130 PLUS single-leaf door, fixed wooden door frame

EI30 PLUS



VERSION solid glazed solid/solid glazed/glazed solid/glazed

LAMINATED CPL 0.2 mm
 LAMINATED HPL EGGER GROUP A
 LAMINATED HPL EGGER GROUP B
 UNI MAT PLUS
 LAMISTONE
 SILKSTONE
 SILKSTONE CPL 0.5 mm
 PAINTED 9003
 MONO1 MAT
 MONO2 MAT
 MONO3 MAT
 VENEERED GROUP A
 VENEERED GROUP B
 VENEERED GROUP C, D
 SILKWOOD / REALWOOD

smoke tightness - extra charge: single-leaf door ; double-leaf door

door in solid version or solid/glazed version (wider door leaf glazed, narrower door leaf solid)

EXTRA CHARGES FOR NON-STANDARD DIMENSIONS OF FIRE DOORS

	standard width	non-standard width "100"	non-standard width "110"
standard height	-	extra charge*	extra charge*
non-standard height up to 2200 mm	extra charge*	extra charge*	extra charge*
non-standard height up to 2300 mm	extra charge*	extra charge*	extra charge*
non-standard height up to 2400 mm	extra charge*	extra charge*	extra charge*
non-standard height up to 2500 mm	extra charge*	extra charge*	extra charge*

*extra charge for the door (door leaf+door frame)
 Color range of metal door frames (p. 311)

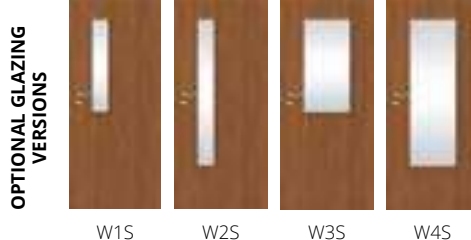

OPTIONAL GLAZING VERSIONS
DOOR LEAFS FOR DOOR FRAME METAL p. 234 **METAL DOOR FRAME pp. 262-265**

DOOR DIMENSIONS

Fixed wooden door frame or adjustable door frame:

Non-rebated system:
 Single-leaf door:
 max. width "110" – 1212 mm, max. height 2500 mm
Version 90 Plus (allows for a minimum clear opening of 900 mm when the door leaf is opened at a 90° angle) 1072x2075 mm
 Double-leaf door:
 max. width "110+110" – 2330 mm, max. height 2500 mm

Fixed metal door frame:

Non-rebated system:
 Single-leaf door:
 max. width "110" – 1224 mm, max. height 2281 mm
Version 90 Plus (allows for a minimum clear opening of 900 mm when the door leaf is opened at a 90° angle) 1084x2081 mm
 Double-leaf door:
 max. width "110+110" – 2340 mm, max. height 2281 mm

Adjustable metal door frame:

Non-rebated system:
 Single-leaf door:
 max. width "110" – 1224 mm, max. height 2281 mm
Version 90 Plus (allows for a minimum clear opening of 900 mm when the door leaf is opened at a 90° angle) 1084x2081 mm
 Double-leaf door:
 max. width "110+110" – 2340 mm, max. height 2281 mm

It is possible to manufacture non-standard door widths and heights after consultation with the Sales Department.

INVESTMENT WIDTH
 Single-leaf door: the width of the door "90 plus" allows for a minimum clear opening of 900 mm when the door leaf is opened at an angle of 90°. Double-leaf door: the width of the active door leaf "90 plus" allows for a minimum clear opening of 900 mm with the active door leaf opened at an angle of 90° and the inactive door leaf locked.

DOOR LEAF FINISH

Smooth surface painted, veneered, covered with CPL laminate with a thickness from 0.2 to 0.7 mm, HPL laminate with a thickness from 0.7 to 1.0 mm, or wood-like foil. Available flat designs, made of decorative profiled strips, aluminum decors.

GLAZING

Transparent glass with EI30 fire resistance. Pine frame painted, veneered, or covered with foil in a color matched to the color of the door leaf. Available porthole-type glazing with a steel frame Ø320 mm (on the outer side of the frame).

DOOR FRAMES

Painted, veneered, or laminated door frame with CPL 0.15 mm, CPL 0.2 mm or foil matched to the color range of the door leaf.

Fixed pine wooden – optionally with masking strips, quarter round.

Adjustable wooden with extension panels, angle trims, and masking strip.

Fixed metal made of 1.5 mm thick steel sheet, standard powder-coated in white (RAL 9016 and RAL 9003), grey (RAL 7047), brown (RAL 8014), beige (NCS S 2005 Y50R), graphite (RAL 7024), black (RAL 9005).

Adjustable metal made of 1.5 mm thick steel sheet, standard powder-coated in white (RAL 9016 and RAL 9003), grey (RAL 7047), brown (RAL 8014), beige (NCS S 2005 Y50R), graphite (RAL 7024), black (RAL 9005).

It is possible to paint door frames in non-standard colors from the RAL or NCS palette after consultation with the Sales Department. The door frame consists of a main part and an angle trim inserted into the main part.

ACCESSORIES AND EQUIPMENT

Standard equipment:
 (door with wooden or metal door frame)
 - 3 OBX type object hinges by ECO SCHULTE or concealed TECTUS hinges by Simonswerk (option for extra charge)
 - mortise lock with patent cylinder
 - drop seal
Additional equipment:
 - aluminum decors - p. 291
 - designs - p. 291

- Surface-mounted or concealed door closer, panic locks, panic bars, electric strikes, electromagnetic locks, reed switch, additional lock – pp. 279-285
 - panoramic peephole - stainless steel; brass, anthracite, black matt
 - change of hinge color to black (1 pc.) (applies to OBX hinges)
 Possibility to prepare milling in the door leaf for a (electronic) hotel lock after consultation with the Sales Department.

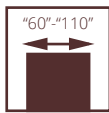

EI60 PLUS door, fixed wooden door frame

FIRE-RESISTANT POL-SKONE REBATED EI60 PLUS HALSPAN SYSTEM

- Fire resistance EI₂60
- acoustic insulation
- single-leaf: class D₁ – 30, D₂ – 25, class Rw=32 dB
- Double-leaf: class D₁ – 25, D₂ – 25, class Rw=32 dB
- 3rd class of mechanical strength according to PN-EN 1192:2001 standard
- Smoke tightness class S_a, S₂₀₀ (option)
- National Technical Assessment ITB-KOT-2018/0407 ed.2
- National Certificate of Constancy of Performance No. 020-UWB-2695/W

ATTENTION! In order to meet fire resistance requirements, a door closer meeting the requirements of the PN-EN 1154:1999/A1:2004/AC:2010 standard, handles for doors meeting the requirements of the PN-EN 1906:2012 standard (min. class B in the scope related to fire resistance) and cylinder inserts meeting the requirements of the PN-EN 1303:2015 standard (class B in the scope related to fire resistance).

EI60 Plus rebated fire door of the Halspan system with metal door frame, optionally equipped with PHA 2000 or PHA 2500 panic hardware and EXACTA 495 hinges ø16 mm meet the requirements of the PN-EN 1125:2009 standard regarding release capability and may be used on escape routes and emergency exits.

Door leaf in a rebated system. The structure of the door leaf consists of a layered chipboard with a softwood insert, covered on both sides with HDF boards. The nominal thickness of the door leaf is 60 mm.



door EI60 PLUS, adjustable wooden door frame



EI60 PLUS



VERSION	solid	glazed	solid/solid	glazed/glazed	solid/glazed
LAMINATED CPL 0.2 mm					
LAMINATED HPL EGGER GROUP A					
LAMINATED HPL EGGER GROUP B					
UNI MAT PLUS					
LAMISTONE					
SILKSTONE					
SILKSTONE CPL 0.5 mm					
PAINTED 9003					
MONO1 MAT					
MONO2 MAT					
MONO3 MAT					
VENEERED GROUP A					
VENEERED GROUP B					
VENEERED GROUP C, D					
SILKWOOD / REALWOOD					
smoke tightness - extra charge: single-leaf door ; double-leaf door			door in solid version or solid/glazed version (wider door leaf glazed, narrower door leaf solid)		

EXTRA CHARGES FOR NON-STANDARD DIMENSIONS OF FIRE DOORS

	standard width	non-standard width "100"	non-standard width "110"
standard height	-	extra charge*	extra charge*
non-standard height up to 2200 mm	extra charge*	extra charge*	extra charge*
non-standard height up to 2300 mm	extra charge*	extra charge*	extra charge*
non-standard height up to 2400 mm	extra charge*	extra charge*	extra charge*
non-standard height up to 2500 mm	extra charge*	extra charge*	extra charge*

*extra charge for the door (door leaf+door frame)
Color range of metal door frames (p. 311)

OPTIONAL GLAZING VERSIONS



W1S

W3S

DOOR LEAFS FOR METAL DOOR FRAME p. 234 METAL DOOR FRAME pp. 262-265

DOOR DIMENSIONS

Fixed wooden door frame or adjustable door frame:
Rebated system:
Single-leaf door:
max. width "110" – 1212 mm, max. height 2500 mm
90 Plus version (allows for a minimum clear opening of 900 mm when the door leaf is opened at an angle of 90°)
1032x2075 mm
Double-leaf door solid:
max. width "110+110" – 2352 mm, max. height 2500 mm
Double-leaf door glazed:
max. width "100+100" – 2152 mm, max. height 2350 mm
Fixed metal door frame:
Rebated system:
Single-leaf door:
max. width "110" – 1204 mm, max. height 2271 mm
90 Plus version (allows for a minimum clear opening of 900 mm when the door leaf is opened at an angle of 90°)
1024x2071 mm
Double-leaf door solid:
max. width "110+110" – 2342 mm, max. height 2271 mm
Double-leaf door glazed:
max. width "100+100" – 2142 mm, max. height 2271 mm

Adjustable metal door frame:
Rebated system:
Single-leaf door:
max. width "110" – 1224 mm, max. height 2281 mm
90 Plus version (allows for a minimum clear opening of 900 mm when the door leaf is opened at an angle of 90°)
1044x2081 mm
Double-leaf door solid:
max. width "110+110" – 2362 mm, max. height 2281 mm
Double-leaf door glazed:
max. width "100+100" – 2162 mm, max. height 2281 mm

INVESTMENT WIDTH
Single-leaf door: the width of the door "90 plus" allows for a minimum clear opening of 900 mm when the door leaf is opened at an angle of 90°.
Double-leaf door: the width of the active door leaf "90 plus" allows for a minimum clear opening of 900 mm with the active door leaf opened at an angle of 90° and the inactive door leaf locked.

DOOR LEAF FINISH

Smooth surface painted, veneered, covered with CPL laminate with a thickness from 0.2 to 0.7 mm, HPL laminate with a thickness from 0.7 to 1.0 mm or wood-like foil. Available flat designs, made of decorative profiled strips, aluminum decors.

GLAZING

Transparent glass with EI60 fire resistance. Pine frame painted, veneered or covered with foil matched to the color of the door leaf. Available porthole-type glazing with a steel frame Ø320 mm (on the outer side of the frame).

DOOR FRAMES

Painted, veneered, or laminated door frame with CPL 0.15 mm, CPL 0.2 mm or foil matched to the color range of the door leaf.
Fixed pine wooden – optionally with masking strips, quarter round.
Wooden adjustable with extension panels, angle trims and masking strip.
Fixed metal made of 1.5 mm thick steel sheet, standard powder-coated in white (RAL 9016 and RAL 9003), grey (RAL 7047), brown (RAL 8014), beige (NCS S 2005 Y50R), graphite (RAL 7024), black (RAL 9005).

Adjustable metal made of 1.5 mm thick steel sheet, standard powder-coated in white (RAL 9016 and RAL 9003), grey (RAL 7047), brown (RAL 8014), beige (NCS S 2005 Y50R), graphite (RAL 7024), black (RAL 9005).

It is possible to paint door frames in non-standard colors from the RAL or NCS palette after consultation with the Sales Department. The door frame consists of a main part and an angle trim inserted into the main part.

ACCESSORIES AND EQUIPMENT

Standard equipment:
(door with wooden or metal door frame) - 4 pin hinges adjustable in 3 planes by OTLAV
- mortise lock with patent cylinder
- drop seal

Additional equipment:
- aluminum decors - p. 291
- designs - p. 291
- surface-mounted or concealed door closer, panic locks, panic bars, electric strikes, electromagnetic locks, reed switch, additional lock – pp. 279-285
Possibility to prepare milling in the door leaf for a (electric) hotel lock after consultation with the Sales Department.

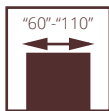

EI60 PLUS door, fixed wooden door frame

FIRE-RESISTANT POL-SKONE NON-REBATED EI60 PLUS HALSPAN SYSTEM

- Fire resistance EI₂60
- Acoustic insulation
- Single-leaf: class D₁ – 30, D₂ – 25, class Rw=32 dB
- Double-leaf: class D₁ – 25, D₂ – 25, class Rw=32 dB
- 3rd class of mechanical strength according to PN-EN 1192:2001 standard
- Smoke tightness class S_a, S₂₀₀ (option)
- National Technical Assessment ITB-KOT-2018/0407 ed.2
- National Certificate of Constancy of Performance No. 020-UWB-2695/W

ATTENTION! In order to meet fire resistance requirements, a door closer meeting the requirements of the PN-EN 1154:1999/A1:2004/AC:2010 standard, handles for doors meeting the requirements of the PN-EN 1906:2012 standard (min. class B in the scope related to fire resistance) and cylinder inserts meeting the requirements of the standard PN-EN 1303:2015 (class B in the scope related to fire resistance).

Door leaf in a non-rebated system. The structure of the door leaf consists of a layered chipboard with a softwood insert, covered on both sides with HDF boards. The nominal thickness of the door leaf is 60 mm.



door EI60 PLUS, adjustable wooden door frame



EI60 PLUS

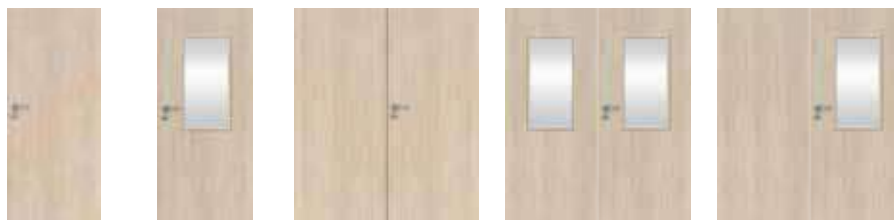

VERSION	solid	glazed	solid/solid	glazed/glazed	solid/glazed
---------	-------	--------	-------------	---------------	--------------

LAMINATED CPL 0.2 mm
 LAMINATED HPL EGGER GROUP A
 LAMINATED HPL EGGER GROUP B
 UNI MAT PLUS
 LAMISTONE
 SILKSTONE
 SILKSTONE CPL 0.5 mm
 PAINTED 9003
 MONO1 MAT
 MONO2 MAT
 MONO3 MAT
 VENEERED GROUP A
 VENEERED GROUP B
 VENEERED GROUP C, D
 SILKWOOD / REALWOOD

smoke tightness - extra charge: single-leaf door ; double-leaf door

door in solid version or solid/glazed version (wider door leaf glazed, narrower door leaf solid)

EXTRA CHARGES FOR NON-STANDARD DIMENSIONS OF FIRE DOORS

	standard width	non-standard width "100"	non-standard width "110"
standard height	-	extra charge*	extra charge*
non-standard height up to 2200 mm	extra charge*	extra charge*	extra charge*
non-standard height up to 2300 mm	extra charge*	extra charge*	extra charge*
non-standard height up to 2400 mm	extra charge*	extra charge*	extra charge*
non-standard height up to 2500 mm	extra charge*	extra charge*	extra charge*

*extra charge for the door (door leaf+door frame)
 Color range of metal door frames (p. 311)

OPTIONAL GLAZING VERSIONS



W1S W3S

DOOR LEAFS FOR DOOR FRAME METAL p. 234 **METAL DOOR FRAME pp. 262-265**

DOOR DIMENSIONS

Fixed wooden door frame or adjustable door frame:

Non-rebated system:
 Single-leaf door:
 max. width "110" – 1212 mm, max. height 2500 mm
Version 90 Plus (allows for a minimum clear opening of 900 mm when the door leaf is opened at a 90° angle) 1072x2075 mm
 Double-leaf door solid:
 max. width "110+110" – 2330 mm, max. height 2500 mm
 Double-leaf door glazed:
 max. width "100+100" – 2130 mm, max. height 2350 mm

Fixed metal door frame:

Non-rebated system:
 Single-leaf door:
 max. width "110" – 1224 mm, max. height 2281 mm
Version 90 Plus (allows for a minimum clear opening of 900 mm when the door leaf is opened at a 90° angle) 1084x2081 mm
 Double-leaf door solid:
 max. width "110+110" – 2340 mm, max. height 2281 mm
 Double-leaf door glazed:
 max. width "100+100" – 2140 mm, max. height 2281 mm

Adjustable metal door frame:

Non-rebated system:
 Single-leaf door:
 max. width "110" – 1224 mm, max. height 2281 mm
Version 90 Plus (allows for a minimum clear opening of 900 mm when the door leaf is opened at a 90° angle) 1084x2081 mm
 Double-leaf door solid:
 max. width "110+110" – 2340 mm, max. height 2281 mm
 Double-leaf door glazed:
 max. width "100+100" – 2140 mm, max. height 2281 mm
 It is possible to manufacture non-standard door widths and heights after consultation with the Sales Department.

INVESTMENT WIDTH

Single-leaf door: the width of the door "90 plus" allows for a minimum clear opening of 900 mm when the door leaf is opened at an angle of 90°.
Double-leaf door: the width of the active "90 plus" door leaf allows for a minimum clear opening of 900 mm when the active door leaf is opened at an angle of 90° and the inactive door leaf is locked.

DOOR LEAF FINISH

Smooth surface painted, veneered, covered with CPL laminate with a thickness from 0.2 to 0.7 mm, HPL laminate with a thickness from 0.7 to 1.0 mm or wood-like foil. Available flat designs, made of decorative profiled strips, aluminum decors.

GLAZING

Transparent glass with EI60 fire resistance. Pine frame painted, veneered or covered with foil matched to the color of the door leaf. Available porthole-type glazing with a steel frame Ø320 mm (on the outer side of the frame).

DOOR FRAMES

Door frame painted, veneered, covered with CPL laminate 0.15 mm, CPL 0.2 mm or foil matched to the color range of the door leaf.
Fixed pine wooden – optionally with masking strips, quarter round.
Wooden adjustable with extension panels, angle trims and masking strip.
Fixed metal made of 1.5 mm thick steel sheet, standard powder-coated in white (RAL 9016 and RAL 9003), grey (RAL 7047), brown (RAL 8014), beige (NCS S 2005 Y50R), graphite (RAL 7024), black (RAL 9005).

Adjustable metal made of 1.5 mm thick steel sheet, standard powder-coated in white (RAL 9016 and RAL 9003), grey (RAL 7047), brown (RAL 8014), beige (NCS S 2005 Y50R), graphite (RAL 7024), black (RAL 9005).

It is possible to paint door frames in non-standard colors from the RAL or NCS palette after consultation with the Sales Department. The door frame consists of a main part and an angle trim inserted into the main part.

ACCESSORIES AND EQUIPMENT

Standard equipment:
 (door with wooden or metal door frame)
 - 3 OBX type object hinges by ECO SCHULTE or concealed TECTUS hinges by Simonswerk (option for extra charge)
 - main lock with patent cylinder
 - drop seal

Additional equipment:
 - aluminum decors - p. 291
 - designs - p. 291
 - change of hinge color to black (1 pc.) (applies to OBX hinges) -
 - surface-mounted or concealed door closer, panic locks, panic bars, electric strikes, electromagnetic locks, reed switch, additional lock – pp. 279-285

Possibility to prepare milling in the door leaf for a (electronic) hotel lock after consultation with the Sales Department.

DOOR LEAF EI30 PLUS, EI60 PLUS, AKUSTIK 32 DB III MECHANICAL CLASS FOR METAL DOOR FRAME



DOOR LEAF EI30 PLUS

VERSION	solid	glazed (W1S, W2S, W3S)	glazed (W4S)	solid	glazed	solid/glazed
---------	-------	---------------------------	-----------------	-------	--------	--------------

LAMINATED CPL 0.2 mm

LAMINATED HPL EGGER GROUP A

LAMINATED HPL EGGER GROUP B

UNI MAT PLUS

LAMISTONE, SILKSTONE

SILKSTONE CPL 0.5 mm

PAINTED 9003

MONO1 MAT

MONO2 MAT

MONO3 MAT

VENEERED A

VENEERED B

VENEERED C, D

SILKWOOD / REALWOOD

smoke tightness - extra charge single-leaf door , double-leaf door

DOOR LEAF EI60 PLUS

VERSION	solid	glazed (W1S, W3S)	glazed (W4S)	solid	glazed	solid/glazed
---------	-------	----------------------	-----------------	-------	--------	--------------

LAMINATED CPL 0.2 mm

LAMINATED HPL EGGER GROUP A

LAMINATED HPL EGGER GROUP B

UNI MAT PLUS

LAMISTONE, SILKSTONE

SILKSTONE CPL 0.5 mm

PAINTED 9003

MONO1 MAT

MONO2 MAT

MONO3 MAT

VENEERED A

VENEERED B

VENEERED C, D

SILKWOOD / REALWOOD

smoke tightness - extra charge single-leaf door , double-leaf door

DOOR LEAF AKUSTIK 32 dB III MECHANICAL CLASS

VERSION	solid	glazed (W1S, W2S, W3S)	glazed (W4S)	solid	glazed	full/glazed
---------	-------	---------------------------	-----------------	-------	--------	-------------

LAMINATED CPL 0.2 mm

UNI MAT PLUS

LAMISTONE, SILKSTONE

SILKSTONE CPL 0.5 mm

PAINTED 9003

MONO1 MAT

MONO2 MAT

MONO3 MAT

VENEERED A

VENEERED B

VENEERED C, D

SILKWOOD / REALWOOD

Color range of metal door frames (p. 311)

In order to meet the requirements of the National Technical Assessment, door leaves are sold as a set with a metal door frame.

FIRE-RESISTANT DOORS FOR SHAFTS - EI30, EI60

- It is recommended to use EI30 Plus, EI60 Plus fire-resistant doors on a fixed wooden door frame with possible door installation in the form of wall panels classified as flame-retardant.
- Doors equipped with a mortise lock with a cylinder hole, without a handle.
- In the case of doors for shafts where there is a temperature difference between two rooms, it is recommended to use ventilation grilles as a ventilation option.



DOORS FOR SHAFTS

LAMINATED CPL 0.2

LAMINATED HPL EGGER GROUP A

LAMINATED HPL EGGER GROUP B

UNI MAT PLUS

LAMISTONE

SILKSTONE

SILKSTONE CPL 0.5 mm

PAINTED RAL 9003

MONO1 MAT

MONO2 MAT

MONO3 MAT

VENEERED GROUP A

VENEERED GROUP B

VENEERED GROUP C, D

SILKWOOD / REALWOOD

EI30 PLUS rebated

width 30, 40, 50 cm

30+30, 30+40, 40+40

EI60 PLUS rebated

width 30, 40, 50 cm

30+30, 30+40, 40+40



FR EI30 door, fixed wooden door frame

FIRE-RESISTANT EMERGENCY EXIT

FR EI30 SR32 doors

(single-leaf and double-leaf door with wooden door frame, full or glazed)

- Fire resistance - EI₃₀
- acoustic insulation
- class D₁ - 30, D₂ - 25, class Rw=32 dB
- 3rd class of mechanical strength according to the standard PN-EN 1192:2001
- National Technical Assessment ITB-KOT-2020/1370 ed. 1
- National Certificate of Performance Consistency no. 020-UWB-1937/W

EI30 Plus doors of the Halspan system (single-leaf and double-leaf door with metal door frame, full or glazed)

- Fire resistance - EI₃₀
- acoustic insulation:
- single-leaf door
- class D₁ - 30, D₂ - 25, class Rw=32 dB
- double-leaf door class D₁ - 25, D₂ - 25, class Rw=27 dB
- 3rd class of mechanical strength according to the PN-EN 1192:2001 standard
- National Technical Assessment ITB-KOT-2018/0407 ed. 2
- National Certificate of Performance Consistency no. 020-UWB-2695/W

EI60 Plus door of the Halspan system

(single-leaf and double-leaf door with metal door frame, solid or glazed)

- Fire resistance - EI₆₀
- acoustic insulation
- single-leaf door
- class D₁ - 30, D₂ - 25, class Rw=32 dB
- double-leaf door
- class D₁ - 25, D₂ - 25, class Rw=32 dB
- 3rd class of mechanical strength according to PN-EN 1192:2001 standard
- National Technical Assessment ITB-KOT-2018/0407 ed. 2
- National Certificate of Performance Consistency no. 020-UWB-2695/W



FR EI30 fire door, fixed wooden door frame



PRICE OF EMERGENCY EXIT FIRE DOOR OF THE POL-SKONE SYSTEM

**= PRICE OF FIRE DOOR OF THE POL-SKONE SYSTEM + PRICE OF DORMAKABA PHA 2000 PANIC BAR (P. 282)
+ PRICE OF OBX OBJECT HINGES (P. 279)**

PRICE OF EMERGENCY EXIT FIRE DOOR EI30 PLUS, EI60 PLUS

= PRICE OF FIRE DOOR EI30 PLUS, EI60 PLUS + PRICE OF DORMAKABA PHA 2000 PANIC BAR (P. 282)

INVESTMENT WIDTH

Single-leaf door: the width of the door "90 plus" allows for a minimum clear opening of 900 mm when the door leaf is opened at an angle of 90°.

Double-leaf door: the width of the active "90 plus" door leaf allows for a minimum clear opening of 900 mm when the active door leaf is opened at an angle of 90° and the inactive door leaf is locked.

extra charge for CPL 0.5 mm for doors with CPL coating (extra charge for standard door height)

DOOR DIMENSIONS

FR EI30 SR32 door, rebated system

single-leaf door:
width "90" - "100" - 1012 - 1112 mm, max. height 2175 mm **90 Plus version (allows for a minimum clear opening of 900 mm when the door leaf is opened at 90°) width 1032 mm.**
double-leaf door:
width "90+60" - "100+100" - 1653 - 2153 mm, max. height 2175 mm.

EI30 Plus door of the Halspan system, rebated system
fixed metal door frame single-leaf door: width "90" - "110" - 1004 - 1204 mm, max. height 2271 mm.
90 Plus version (allows for a minimum clear opening of 900 mm when the door leaf is opened at 90°) width 1024 mm.

double-leaf door: width "90+60" - "110+110" - 1642 - 2342 mm, max. height 2271 mm.
adjustable metal door frame
single-leaf door:
width "90" - "110" - 1024 - 1224 mm, max. height 2281 mm.
90 Plus version (allows for a minimum clear opening of 900 mm when the door leaf is opened at 90°) width 1044 mm.
double-leaf door:
width "90+60" - "110+110" - 1662 - 2362 mm, max. height 2281 mm.

EI60 Plus door of the Halspan system, rebated system

fixed metal door frame.
single-leaf door:
width "90" - "110" - 1004 - 1204 mm, max. height 2271 mm.
90 Plus version (allows for a minimum clear opening of 900 mm when the door leaf is opened at 90°) width 1024 mm.
double-leaf door solid:
width "90+60" - "110+110" - 1642 - 2342 mm, max. height 2271 mm.
double-leaf door glazed: "90+60" - "100+100" - 1642 - 2142 mm, max. height 2271 mm.
adjustable metal door frame.
single-leaf door:
width "90" - "110" - 1024 - 1224 mm, max. height 2281 mm.
90 Plus version (allows for a minimum clear opening of 900 mm when the door leaf is opened at 90°) width 1044 mm.
double-leaf door solid:
width "90+60" - "110+110" - 1662 - 2362 mm, max. height 2281 mm.
double-leaf door glazed: "90+60" - "100+100" - 1662 - 2162 mm, max. height 2281 mm.

DOOR LEAF FINISH

Smooth surface painted, veneered, covered with CPL laminate with thickness from 0.2 mm to 0.7 mm, HPL laminate with thickness from 0.7 mm to 1 mm, or wood-like foil. Decorative designs made of ornamental profile strips and aluminum decors are available.

GLAZINGS

Transparent glass with fire resistance EI30 or EI60. Frame painted, veneered or covered with foil in a color matched to the color of the door leaf.

DOOR FRAMES

Door frame painted, veneered, covered with CPL laminate 0.15 mm, CPL 0.2 mm or foil matched to the color range of the door leaf.
Fixed pine wood - optionally with masking strips, quarter round.

Adjustable wooden with extension panels, angle trims, and masking strip.
Metal fixed or adjustable EI30 PLUS or EI60 PLUS.

ACCESSORIES AND EQUIPMENT

Standard equipment FR EI30 SR32:
- 3 OBX type object hinges by Eco Schulte
- Dormakaba PHA 2102 surface-mounted panic bar (p. 282)
- drop seal

Standard equipment EI30 Plus of the Halspan system:
- 3 or 4 butt hinges adjustable in 3 planes EXACTA 495 Ø16 by OTLAV
- single-leaf door - Dormakaba PHA 2000 surface-mounted panic bar or Dormakaba PHA 2500 panic bar with mortise lock
- double-leaf door - Dormakaba PHA 2000 surface-mounted panic bar
- drop seal

Standard equipment EI60 Plus of the Halspan system:
- 4 butt hinges adjustable in 3 planes EXACTA 495 Ø16 by OTLAV
- single-leaf door - Dormakaba PHA 2000 surface-mounted panic bar or Dormakaba PHA 2500 panic bar with mortise lock
- double-leaf door - Dormakaba PHA 2000 surface-mounted panic bar
- drop seal

Additional equipment:
FR EI30 SR32 door
- aluminum decors, reed switch, surface-mounted door closer
EI30 Plus door of the Halspan system
- aluminum decors, surface-mounted door closer
EI60 Plus door of the Halspan system
- aluminum decors, surface-mounted door closer

- **fixed or adjustable**
- **wooden, steel or made of MDF**
- **architraves joined at an angle of 45° and 90°**
- **for interior, entrance, and technical doors**
- **rebated system, hidden, non-rebated system, reverse rebate**

DOOR FRAMES

The primary criterion distinguishing door frames is their construction, which can be fixed or adjustable.

A well-chosen one should match both technically – to the wall thickness, and aesthetically – to the interior style as well as the version and color of the door leaf.







door frame **FIXED** POL-SKONE



LAMISTONE CPL	laminated CPL 0.2	PAINTED 9003
SILKSTONE		
UNI MAT PLUS		

single-leaf door
double-leaf door

		VENEERED		
MONO1 MAT	MONO2 MAT	GROUP A	GROUP B	GROUP C, D SILKWOOD REALWOOD

single-leaf door
double-leaf door

EXTRA CHARGES

color range MONO3 MAT (extra charge for the basic color RAL 9003)	
door frames lower by 50 mm or 100 mm	without extra charge
door frames higher by 50 mm or 100 mm	
door frames higher by 150 mm or 200 mm	
"100"	
"110"	
fail-secure electric strike JJS 1710 12-24V AC/DC (including strike plate and milling for electric strike) *	
fail-secure electric strike BIRA HARTTE XS narrow XS12U 12V AC/DC (including plate and milling for electric strike)*	
fail-secure electric strike with switch BIRA HARTTE XS12UW 12V AC/DC (including strike plate and milling for electric strike)*	
fail-safe electric strike BIRA HARTTE XS narrow XS12R 12V DC (including strike plate and milling for electric strike)*	

* for door leaves equipped with ECO Schulte GBS 12 lock – extra charge

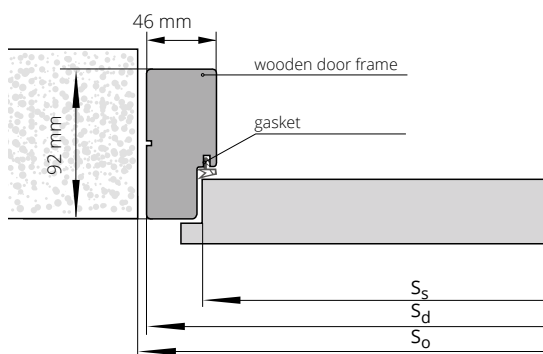

WIDTH						
single-leaf door			double-leaf door			
type	S_o	S_d	S_s	type	S_o	S_d
"60"	715	695	618	"60"+"60"	1350	1329
"70"	815	795	718	"60"+"70"	1450	1429
"80"	915	895	818	"60"+"80", "70"+"70"	1550	1529
"90"	1015	995	918	"60"+"90", "70"+"80"	1650	1629
"90 plus"	1025	1005	928	"70"+"90", "80"+"80"	1750	1729
				"80"+"90"	1850	1829
				"90"+"90"	1950	1929
HEIGHT				H_o	H_d	H_s
				2080	2067	2020

S_s – width of the door leaf
 S_d – width of the door on the outside of the door frame
 S_o – width of the installation opening

H_s – height of the door leaf
 H_d – height of the door on the outside of the door frame
 H_o – height of the installation opening



door frame **FIXED** SYSTEM DUO



LAMISTONE CPL	laminated CPL 0.2	PAINTED 9003
SILKSTONE		
UNI MAT PLUS		

single-leaf door
double-leaf door

		VENEERED		
MONO1 MAT	MONO2 MAT	GROUP A	GROUP B	GROUP C, D SILKWOOD REALWOOD

single-leaf door
double-leaf door

EXTRA CHARGES

color range MONO3 MAT (extra charge for the basic color RAL 9003)	
door frames lower by 50 mm or 100 mm	without extra charge
door frames higher by 50 mm or 100 mm	
door frames higher by 150 mm or 200 mm	
electric strike BIRA HARTTE XS narrow with slide (fail-safe) XS12R-C 12V DC (including SPEC-525 strike plate and milling for electric strike)*	
electric strike BIRA HARTTE XS narrow with slide (fail-secure) XS12U-C 12V AC/DC (including SPEC-525 strike plate and milling for electric strike)*	
electric strike BIRA HARTTE XS narrow with slide (fail-secure with switch) XS12UW-C 12V AC/DC (including SPEC-525 strike plate and milling for electric strike)*	

* for door leaves equipped with ECO Schulte GBS 12 lock - extra charge

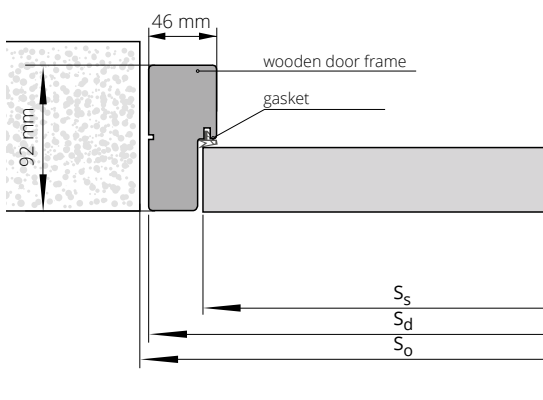

WIDTH						
single-leaf door				double-leaf door		
type	S _o	S _d	S _s	type	S _o	S _d
"60"	720	701	625	"60"+"60"	1340	1316
"70"	820	801	725	"60"+"70"	1440	1416
"80"	920	901	825	"60"+"80", "70"+"70"	1540	1516
"90"	1020	1001	925	"60"+"90", "70"+"80"	1640	1616
"90 plus"	1045	1026	950	"70"+"90", "80"+"80"	1740	1716
				"80"+"90"	1840	1816
				"90"+"90"	1940	1916
HEIGHT				H _o	H _d	H _s
				2080	2067	2020

S_s - width of the door leaf
S_d - width of the door on the outside of the door frame
S_o - width of the installation opening

H_s - height of the door leaf
H_d - height of the door on the outside of the door frame
H_o - height of the installation opening



door frames

ADJUSTABLE

REBATED

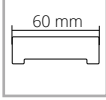
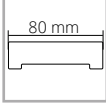
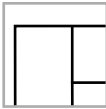
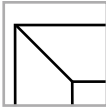

DIN
made of high-quality MDF

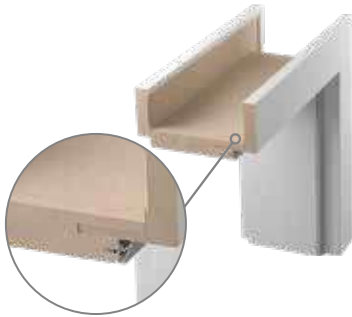

DIN AQUA
made of high-quality MDF, which is characterized by increased moisture resistance

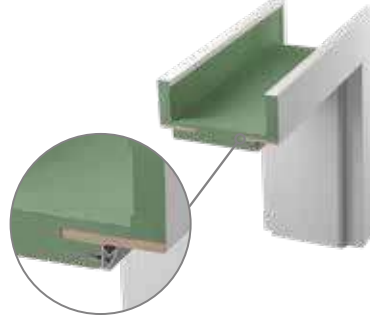

DIN SOLID
made of high-quality laminated wood (main part), trims made of high-quality MDF

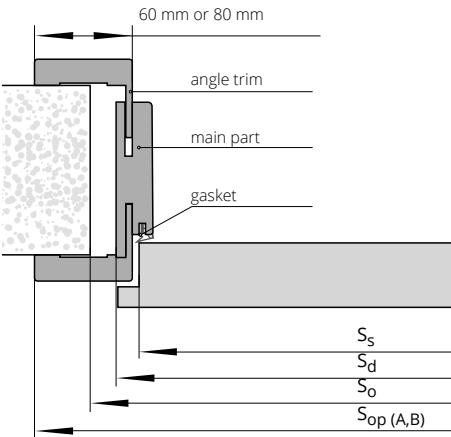

WIDTH										
single-leaf door						double-leaf door				
type	So	Sd	Ss	SopA	SopB	type	So	Sd	SopA	SopB
"60"	676	646	618	748	788	"60"+"60"	1320	1280	1382	1422
"70"	776	746	718	848	888	"60"+"70"	1420	1380	1482	1522
"80"	876	846	818	948	988	"60"+"80","70"+"70"	1520	1480	1582	1622
"90"	976	946	918	1048	1088	"60"+"90","70"+"80"	1620	1580	1682	1722
"90 plus"	986	956	928	1058	1098	"70"+"90","80"+"80"	1720	1680	1782	1822
"100"	1076	1046	1018	1148	1188	"80"+"90"	1820	1780	1882	1922
"110"	1176	1146	1118	1248	1288	"90"+"90"	1920	1880	1982	2022

HEIGHT										
Dimensional tolerance ±1mm										
						H _o	H _d	H _s	H _{opA}	H _{opB}
						2055	2043	2020	2093	2113

So - width of the installation opening
 Hd - height of the door on the outside of the door frame
 Sd - width of the door on the outside of the door frame
 Ss - width of the door leaf
 SopA - width of the door frame after "60" trims
 SopB - width of the door frame after "80" trims
 Ho - height of the installation opening
 Hd - height of the door on the outside of the door frame
 Hs - height of the door leaf
 HopA - height of the door frame after "60" trims
 HopB - height of the door frame after "80" trims

double-leaf door	
"100"	
"110"	

TRIM JOINTS



version A
joint angle 45°
width 60 mm
without extra charge



version B
joint angle 45°
width 80 mm
without extra charge

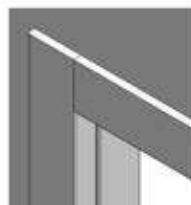

version C
joint angle 90°
width 80 mm



version D
joint angle 90°
width 60 mm

OTHER EXTRA CHARGES

color range MONO3 MAT (extra charge for the basic color RAL 9003)

fail-secure electric strike JIS 1710 12-24V AC/DC (including strike plate and milling for electric strike) *

fail-secure electric strike BIRA HARTTE XS narrow XS12U 12V AC/DC (including strike plate and milling for electric strike)*

fail-secure electric strike with switch XS12UW 12V AC/DC (including strike plate and milling for electric strike)*

fail-safe electric strike BIRA HARTTE XS narrow XS12R 12V DC (including strike plate and milling for electric strike)*

reinforcement for arm/rail door closer**

replacement of hinge type B with type K

three-part hinge type T

crown

* for door leaves equipped with ECO Schulte GBS 12 lock, the width of the installation opening increased by an additional 15 mm

**ATTENTION! Recommended installation opening height increased by 16 mm

range [mm]	75-85	85-95	95-120	120-140	140-160	160-180	180-200	200-220	220-240	240-260	260-280	280-300
symbol	ZP1A	ZP1B	ZP2	ZP3	ZP4	ZP5	ZP6	ZP7	ZP8	ZP9	ZP10	ZP11

DIN / DIN AQUA / DIN SOLID

ECO TOP	LAMISTONE	LAMINATED CPL 0.2	PAINTED RAL 9003	MONO1 MAT	MONO2 MAT	VENEERED GROUP A	VENEERED GROUP B	VENEERED GROUP C, D
	SILKSTONE							SILKWOOD
	UNI MAT PLUS							REALWOOD





door frames

ADJUSTABLE

NON-REBATED

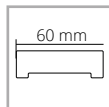
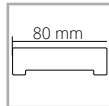
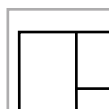
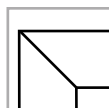

DIN DUO
made of high-quality MDF

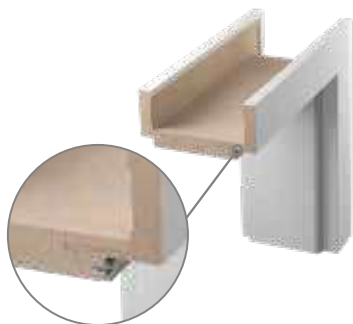

AQUA DIN DUO
made of high-quality MDF, which is characterized by increased moisture resistance

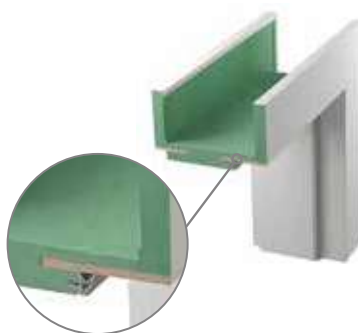

SOLID DIN DUO
made of high-quality laminated wood (main part), trims made of high-quality MDF

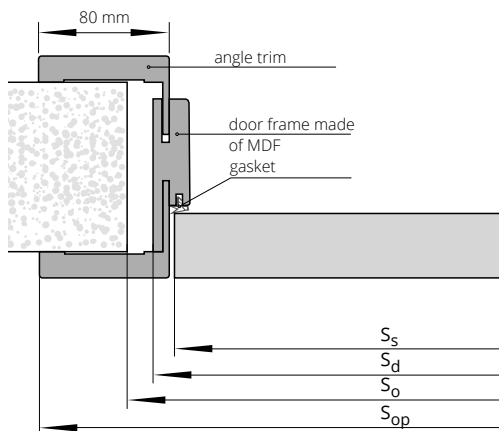

WIDTH									
single-leaf door					double-leaf door				
type	So	Sd	Ss	Sop	type	So	Sd	SopB	
"60"	690	652	625	794	"60"+"60"	1304	1266	1408	
"70"	790	752	725	894	"60"+"70"	1404	1366	1508	
"80"	890	852	825	994	"60"+"80","70"+"70"	1504	1466	1608	
"90"	990	952	925	1094	"60"+"90","70"+"80"	1604	1566	1708	
"90 plus"	1015	977	928	1119	"70"+"90","80"+"80"	1704	1666	1808	
"100"	1090	1052	1018	1194	"80"+"90"	1804	1766	1908	
"110"	1190	1152	1125	1294	"90"+"90"	1904	1866	2008	

HEIGHT				
	H_o	H_d	H_s	H_{opB}
Dimensional tolerance ± 1 mm	2055	2043	2020	2113

So - width of the installation opening
 Sd - width of the door on the outside of the door frame
 Ss - width of the door leaf
 SopA - width of the door frame after "60" trims
 SopB - width of the door frame after "80" trims

H_o - height of the installation opening
 H_d - height of the door on the outside of the door frame
 H_s - height of the door leaf
 HopA - height of the door frame after "60" trims
 HopB - height of the door frame after "80" trims

double-leaf door
"100"
"110"

TRIM JOINTS

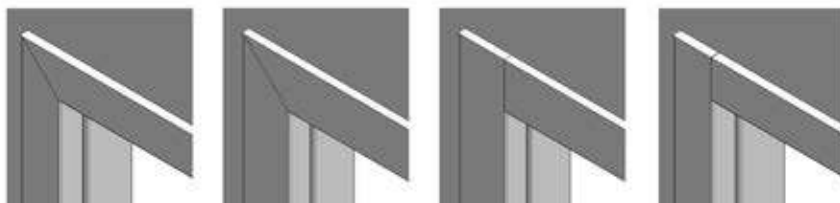

version A
joint angle 45°
width 60 mm
without extra charge

version B
joint angle 45°
width 80 mm
without extra charge

version C
joint angle 90°
width 80 mm

version D
joint angle 90°
width 60 mm

OTHER EXTRA CHARGES

- color range MONO3 MAT (extra charge for the basic color RAL 9003)
- trims joined at an angle of 90° - version C 90°
- BIRA HARTTE XS narrow electric strike with latch (reversible) XS12R-C 12V DC (including SPEC-525 strike plate and milling for electric strike)*
- BIRA HARTTE XS narrow electric strike with latch (non-reversible) XS12U-C 12V AC/DC (including SPEC-525 strike plate and milling for electric strike)*
- BIRA HARTTE XS narrow electric strike with latch (non-reversible with switch) XS12UW-C 12V AC/DC (including SPEC-525 strike plate and milling for electric strike)*
- reinforcement for door closer**
- crown

* for door leaves equipped with ECO Schulte GBS 12 lock, factory-made milling in trims for electric strike
 ** **ATTENTION!** The recommended height dimension of the installation opening increased by 16 mm.

range [mm]	75-85	80-85	85-95	95-120	120-140	140-160	160-180	180-200	200-220	220-240	240-260	260-280	280-300
symbol	ZD1	ZD2	ZD3	ZD4	ZD5	ZD6	ZD7	ZD8	ZD9	ZD10	ZD11	ZD12	ZD13

DIN DUO / DIN DUO AQUA / DIN DUO SOLID

ECO TOP	LAMISTONE	LAMINATED CPL 0.2	PAINTED RAL 9003	MONO1 MAT	MONO2 MAT	VENEERED GROUP A	VENEERED GROUP B	VENEERED GROUP C, D
	SILKSTONE							SILKWOOD
	UNI MAT PLUS							REALWOOD





REVES SYSTEM

reverse rebate

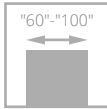

door leaf in the REVES system (on the left), right - opening inward;
door leaf in the DUO system (on the right), left - opening outward

The combination of the DUO and REVES systems provides new arrangement possibilities. It allows for maintaining an identical appearance of the door from the corridor side, even when they open in different directions. The surface of the door leaves in both systems is flush with the surface of the door frame, creating a single plane. The hinges remain concealed, so from the corridor side, no difference in their construction will be noticeable.

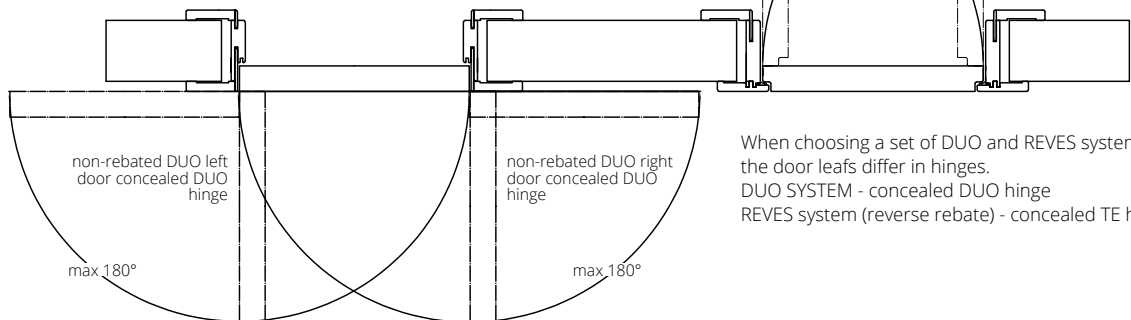

When choosing a set of DUO and REVES systems, the door leaves differ in hinges.
DUO SYSTEM - concealed DUO hinge
REVES system (reverse rebate) - concealed TE hinge

REVES DOOR LEAF AVAILABLE IN MODELS

GLAZED	SOLID (without glazing)
Painted ESTATO (versions A01, A02)	Painted VILANO, VERTIGO, MODERN, MODENA, PALAZZO, CAMBIO, SUBLIME, ESTATO, TIARA, PRINCESTONE
Laminated CREATO (versions A01, A02), IMPULS (versions W13, W14)	Laminated INVERNO, SONATA, CREATO, ZENN, HAPTIC, DECO, IMPULS, INTER-AMBER
Veneered ESPINA (version W01), ESTATO LUX (versions A01, A02)	Veneered ESPINA, DECO LUX, ESTATO LUX, SONATA LUX



concealed DUO hinge, silver color
- DUO system



concealed TE hinge, silver color
- REVES system (reverse rebate)

EQUIPMENT

STANDARD

recessed magnetic lock, for key (spacing 90 mm), for cylinder (spacing 85 mm), or for bathroom lock (spacing 90 mm)

hinges: concealed TE, satin chrome color ("60"- "80" - 2 pcs., "90"- "100" - 3 pcs.)

no possibility to use an electric strike

no possibility to make ABS edging

ADDITIONAL (for extra charge)

perforated chipboard filling

solid chipboard filling (third hinge recommended)

drop seal

third hinge in the door leaf (price per 1 pc.):

concealed TE for width "60"- "80"

change of hinge and lock color p. 278, 280

door higher by 50 mm or 100 mm (third hinge required for extra charge)

door higher by 200 mm (third hinge required for extra charge) Cambio 00, Haptic 00, Impuls W01, Deco 00, Deco Lux 00

door lower by 50 mm or 100 mm without extra charge

maximum height of the door with REVES door frame - 2268 mm



door leaf in the REVES system (on the left), right - opening inward; door leaf in the DUO system (on the right), left - opening outward





door frame ADJUSTABLE REVES SYSTEM



single-leaf door	ECO TOP	LAMISTONE CPL	laminated CPL 0.2	PAINTED 9003
		SILKSTONE		
		UNI MAT PLUS		

ZW1	75-95
ZW2	95-115
ZW3	115-135
ZW4	135-155
ZW5	155-175
ZW6	175-195
ZW7	195-215
ZW8	215-235
ZW9	235-255
ZW10	255-275
ZW11	275-295

single-leaf door	MONO1 MAT	MONO2 MAT	VENEERED		GROUP C, D SILKWOOD REALWOOD
			GROUP A	GROUP B	

ZW1	75-95
ZW2	95-115
ZW3	115-135
ZW4	135-155
ZW5	155-175
ZW6	175-195
ZW7	195-215
ZW8	215-235
ZW9	235-255
ZW10	255-275
ZW11	275-295

EXTRA CHARGES

color range MONO3 MAT (extra charge for the basic color RAL 9003)
door frame higher by 100 mm
change of hinge color from chrome matt to black (RAL 9005) or white RAL (9016) (1 pc.)
trims joined at a 90° angle

type	So	Sd	Ss	SopA	SopB	SopBF
"60"	705	676	625	768	818	820
"70"	805	776	725	868	918	920
"80"	905	876	825	968	1018	1020
"90"	1005	976	925	1068	1118	1120
"90 plus"	1030	1001	950	1093	1143	1145
"100"	1105	1076	1025	1168	1218	1220

type	Hd	HopA	HopB	Hs	Ho
standard	2068	2113	2138	2033	2085
+50	2118	2163	2188	2083	2135
+100	2168	2213	2238	2133	2185
+200	2268	2313	2338	2233	2285
-50	2018	2063	2088	1983	2035
-100	1968	2013	2038	1933	1985

Dimensional tolerance ±1mm

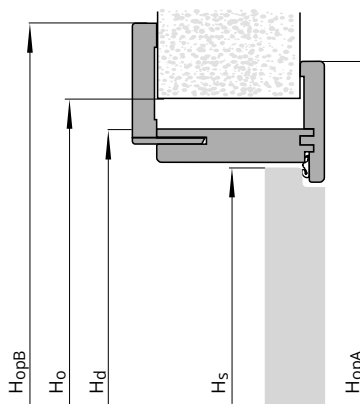
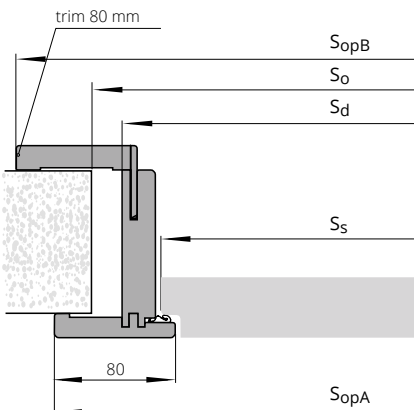

Ss – width of the door leaf Sd – width of the door on the outside of the door frame
So – width of the installation opening
SopA – width on the outer side of the trim on the hinge side
SopB – width on the outer side of the trim on the adjustment side
SopBF - dimension on the outer side of the door frame for veneered doors

Hs – height of the door leaf
Hd – height of the door on the outside of the door frame
Ho – height of the installation opening
HopA – height on the outer side of the trim on the hinge side
HopB – height on the outer side of the trim on the adjustment side



door frame ADJUSTABLE VERTIGO



**SET PRICE
=
VERTIGO DOOR FRAME PRICE
+ VERTIGO PANEL PRICE**

METHOD OF JOINING TRIMS WITH THE PANEL
vertical grain

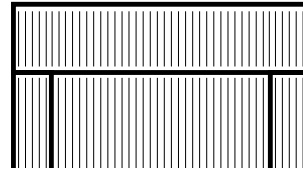

single-leaf door			UNI MAT PLUS				VENEERED		
			LAMISTONE CPL	PAINTED 9003	MONO1 MAT	MONO2 MAT	GROUP A	GROUP B	GROUP C, D SILKWOOD REALWOOD
symbol	range in mm	completion (panel/adjustable trim) in mm	SILKSTONE						
ZV1	75-80	75/12							
ZV2	80-85	80/12							
ZV3	85-95	85/16							
ZV4	95-120	95/32							
ZV5	120-140	120/32							
ZV6	140-160	140/32							
ZV7	160-180	160/32							
ZV8	180-200	180/32							
ZV9	200-220	200/32							
ZV10	220-240	220/32							
ZV11	240-260	240/32							
ZV12	260-280	260/32							
ZV13	280-305	280/32							

EXTRA CHARGES

color range MONO3 MAT (extra charge for the basic color RAL 9003)

door frames lower by 50 mm or 100 mm without extra charge

door frames higher by 50 mm or 100 mm

reinforcement for surface door closer*

BIRA HARTTE XS narrow electric strike with latch (reversible) XS12R-C 12V DC (including SPEC-525 strike plate and milling for electric strike)**

BIRA HARTTE XS narrow electric strike with latch (non-reversible) XS12U-C 12V AC/DC (including SPEC-525 strike plate and milling for electric strike)**

BIRA HARTTE XS narrow electric strike with latch (non-reversible with switch) XS12UW-C 12V AC/DC (including SPEC-525 strike plate and milling for electric strike)**

It is possible to manufacture door frames with larger ranges than the maximum specified in the above table (after consultation with the Sales Department)

** ATTENTION! The recommended height dimension of the installation opening increased by 16 mm.

** for door leaves equipped with ECO Schulte GBS 12 lock – extra charge, the width dimension of the installation opening increased by 15 mm

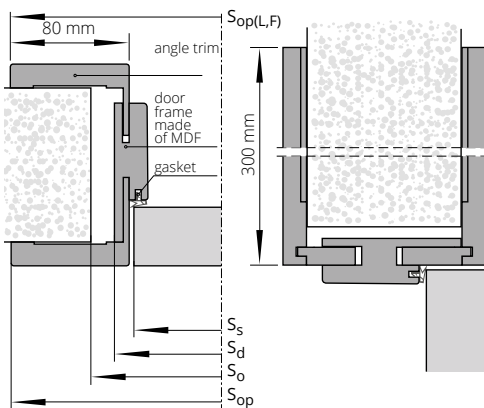

WIDTH						
single-leaf door						
type	S _o	S _d	S _s	S _{op}	S _{opL}	S _{opF}
"60"	690	652	625	793	793	795
"70"	790	752	725	893	893	895
"80"	890	852	825	993	993	995
"90"	990	952	925	1093	1093	1095
"90 plus"	1015	977	950	1117	1118	1120

HEIGHT		
	H _o	H _{op} *
	2062	2050 2333

S_s – width of the door leaf S_d – width of the door on the outside of the door frame
 S_o – width of the installation opening
 S_{op} – door frame dimension on the hinge side
 S_{opL} – door frame dimension from the adjustment side for laminated and painted door frames
 S_{opF} – door frame dimension from the adjustment side for veneered door frames
 H_s – height of the door leaf
 H_d – height of the door on the outside of the door frame
 H_o – height of the installation opening
 H_{op} – height on the outer side of the trim

* applies to panel 300

VERTIGO TRANSOM PANEL

SET PRICE = VERTIGO DOOR FRAME PRICE + VERTIGO PANEL PRICE

VERTIGO PANEL 1 set (2 pcs.)

VERTIGO top panels have R3 radii on the vertical edges in the LAMISTONE, SILKSTONE, UNI MAT PLUS, and painted versions. Does not apply to the veneered version.

Panel without version continuation (smooth)

panel height	UNI MAT PLUS	PAINTED 9003	MONO1 MAT	MONO2 MAT	VENEERED			
	LAMISTONE CPL				GROUP A	GROUP A herringbone	GROUP B	GROUP C, D
	SILKSTONE							
100 mm								
200 mm								
300 mm								
400 mm								
500 mm								
600 mm								
700 mm								
800 mm								
900 mm								
1000 mm								

color range MONO3 MAT (extra charge for basic color RAL 9003)

TIARA, SONATA, SALEA version W09, W10



panel height	UNI MAT PLUS	PAINTED 9003	MONO1 MAT	MONO2 MAT	VENEERED		
	LAMISTONE CPL				GROUP A	GROUP B	GROUP C, D SILKWOOD REALWOOD
	SILKSTONE						
300 mm							
400 mm							
500 mm							
600 mm							
700 mm							
800 mm							
900 mm							
1000 mm							

color range MONO3 MAT (extra charge for basic color RAL 9003)

TIARA, SONATA, SALEA version W11



panel height	UNI MAT PLUS	PAINTED 9003	MONO1 MAT	MONO2 MAT	VENEERED		
	LAMISTONE CPL				GROUP A	GROUP B	GROUP C, D SILKWOOD REALWOOD
	SILKSTONE						
300 mm							
400 mm							
500 mm							
600 mm							
700 mm							
800 mm							
900 mm							
1000 mm							

color range MONO3 MAT (extra charge for basic color RAL 9003)

VERTIGO TRANSOM PANEL

SET PRICE = VERTIGO DOOR FRAME PRICE + VERTIGO PANEL PRICE

VERTIGO PANEL 1 set (2 pcs.)

VERTIGO top panels have R3 radii on the vertical edges in the LAMISTONE, SILKSTONE, UNI MAT PLUS, and painted versions. Does not apply to the veneered version.

ADORE version 1 frame



ADORE
1 frame

panel height	UNI MAT PLUS	PAINTED 9003	MONO1 MAT	MONO2 MAT	VENEERED		
	LAMISTONE CPL				GROUP A	GROUP B	GROUP C, D SILKWOOD REALWOOD
500 mm	SILKSTONE						
600 mm							
700 mm							
800 mm							
900 mm							
1000 mm							

color range MONO3 MAT (extra charge for basic color RAL 9003)

ADORE version 2 frames



ADORE
2 frames

panel height	UNI MAT PLUS	PAINTED 9003	MONO1 MAT	MONO2 MAT	VENEERED		
	LAMISTONE CPL				GROUP A	GROUP B	GROUP C, D SILKWOOD REALWOOD
500 mm	SILKSTONE						
600 mm							
700 mm							
800 mm							
900 mm							
1000 mm							

color range MONO3 MAT (extra charge for basic color RAL 9003)

TEO version VF1



TEO
version VF1

panel height	VENEERED
	GROUP A
300 mm	
400 mm	
500 mm	
600 mm	
700 mm	
800 mm	
900 mm	
1000 mm	

TUNNELS / WALL ENCLOSURE

VERTIGO TUNNEL DOOR FRAME

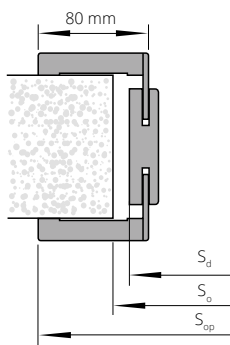

type	S _d	S _o	S _{opL}	S _{opF}
"60"	652	680	793	795
"70"	752	780	893	895
"80"	852	880	993	995
"90"	952	980	1093	1095

HEIGHT	H _d	H _o
	2050	2062

Dimensional tolerance ± 1 mm

Adjustment range	Range in mm	Component set Vertical elements	PAINTED 9003*	MONO1 MAT	MONO2 MAT	UNI MAT PLUS LAMISTONE	VENEERED		
						SILKSTONE	GROUP A	GROUP B	GROUP C, D REALWOOD
VT1	76-96	Panel 76 mm, trim with tongue 32 mm							
VT2	96-116	Panel 76 mm, trim with tongue 32 mm							
VT3	116-142	Panel 76 mm, trim with feather 52 mm							
VT4	142-182	Panel 142 mm, trim with feather 32 mm							
VT5	182-208	Panel 142 mm, trim with feather 52 mm							
VT6	208-248	Panel 208 mm, trim with feather 32 mm							
VT7	248-274	Panel 208 mm, trim with feather 52 mm							
VT8	274-314	Panel 274 mm, trim with feather 32 mm							
VT9	314-354	Panel 274 mm, trim with feather 52 mm							

Net price - main part of the tunnel installation

* applies to trims with a width of 80 mm

SET PRICE = PRICE OF THE VERTIGO TUNNEL DOOR FRAME + PRICE OF THE VERTIGO PANEL

FINISHING TUNNEL FOR WALL INSTALLATION

Adjustment range	Component set	ECO TOP	PAINTED 9003*	MONO1 MAT	MONO2 MAT	LAMISTONE CPL	VENEERED		
						SILKSTONE	GROUP A	GROUP B	GROUP C, D REALWOOD
Wall-mounted system	Range in mm	Standard dimensions				UNI MAT PLUS			
ZN 1	76-116	Panel 76 mm, trim with feather 32 mm							
ZN 2	116-142	Panel 76 mm, trim with feather 52 mm							
ZN 3	142-182	Panel 142 mm, trim with feather 32 mm							
ZN 4	182-208	Panel 142 mm, trim with feather 52 mm							
ZN 5	208-248	Panel 208 mm, trim with feather 32 mm							
ZN 6	248-274	Panel 208 mm, trim with feather 52 mm							
ZN 7	274-314	Panel 274 mm, trim with feather 32 mm							
ZN 8	314-354	Panel 274 mm, trim with feather 52 mm							

EXTRA CHARGES

color range MONO3 MAT (extra charge for the basic color RAL 9003)	
non-standard tunnel height (up to 2300 mm)	
double-leaf tunnels dimension "100"+"100"	
double-leaf tunnels dimension "110"+"110"	
DIN AQUA tunnel door frame	after consultation with the Sales Department
"100"; "110"	
trims joined at an angle of 90° (applies to trims version B - 80 mm)	

* applies to trims with a width of 80 mm

ZN TUNNEL DOOR FRAME (wall installation without the use of doors with DIN and DIN DUO door frames)

WIDTH									
single-leaf door					double-leaf door				
type	S _d	S _o	S _{opA}	S _{opB}	type	S _d	S _o	S _{opA}	S _{opB}
"60"	646	670	748	788	"60"+"60"	1280	1305	1382	1422
"70"	746	770	848	888	"70"+"70"	1480	1505	1582	1622
"80"	846	870	948	988	"80"+"80"	1680	1705	1782	1822
"90"	946	970	1048	1088	"90"+"90"	1880	1905	1982	2022
"100"	1049	1070	1146	1186	"100"+"100"	2080	2105	2182	2222
HEIGHT						H _d	H _o	H _{opA}	H _{opB}
						2043	2055	2093	2113

Dimensional tolerance ± 1 mm

ZN tunnel with trims version A (60 mm)

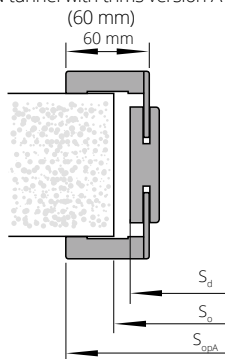

ZN tunnel with trims version B (80 mm)

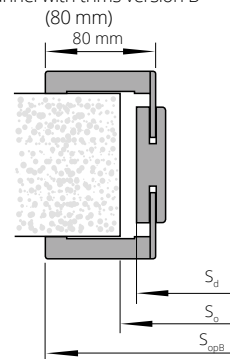

S_d - width of the door on the outer side of the door frame
 S_o - width of the installation opening
 S_{opA} - width on the external side of the trim version A
 S_{opB} - width on the external side of the trim version B

H_d - height of the door on the outside of the door frame
 H_o - height of the installation opening
 H_{opA} - height on the external side of the trim version A
 H_{opB} - height on the external side of the trim version B

DOOR FRAMES FOR SOUNDPROOF DOORS TYPE A, TYPE B, TYPE A DUO, TYPE B DUO

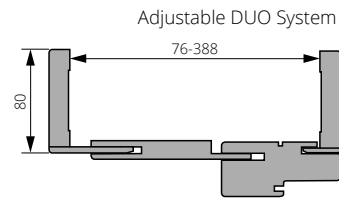
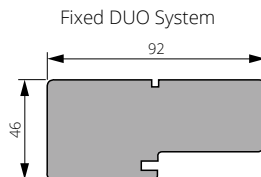
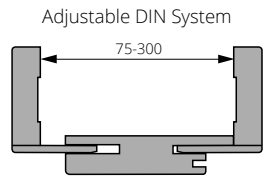
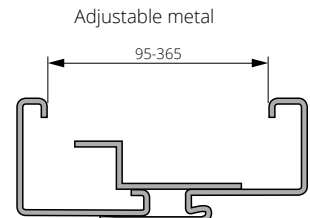
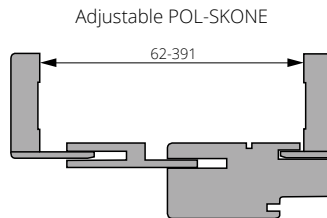
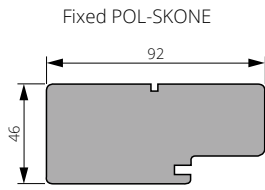

It is possible to manufacture adjustable door frames with non-standard ranges.

CROWNS

FOR DOOR FRAME: DIN SYSTEM, DIN SOLID SYSTEM, DIN DUO SYSTEM, DIN DUO SOLID SYSTEM



crown for single-leaf door for one side

Crown for single-leaf door "60"- "90" for one side (1 pc.)

ECO TOP surface

Surfaces LAMISTONE CPL, SILKSTONE, UNI MAT PLUS

Painted

Veneered GROUP A, B, C, D, SILKWOOD, REALWOOD



EXTRA CHARGES for double-leaf doors

crown "100", "110"

MONO1 MAT

MONO2 MAT

MONO3 MAT

nominal dimension	for door frame DIN, DIN SOLID, ZN Tunnels			for door frame DIN DUO, DIN DUO SOLID			for adjustable wooden door frame POL-SKONE system (applies to soundproof doors type A and type B)			for adjustable wooden door frame DUO system (applies to soundproof doors type A DUO and type B DUO)			for door frame REVES system	
	trim type A width 60 mm	trim type B width 80 mm	trim width 80 mm	hinge side range ZZ1-ZZ17	adjustment side range ZZ4-ZZ11	adjustment side range ZZ1-ZZ3	hinge side range D11-D116	adjustment side range D13-D116	adjustment side range D11-D12	adjustment side	side opposite to adjustment			
total width of the door frame with crown Sk [mm]														
"60"	824	864	870	875	865	913	903	895	845					
"70"	924	964	970	975	965	1013	1003	995	945					
"80"	1024	1064	1070	1075	1065	1113	1103	1095	1045					
"90"	1124	1164	1170	1175	1165	1213	1203	1195	1145					
"90 plus"	1134	1174	1195	1185	1175	1238	1228	1220	1170					
"100"	1224	1264	1270	1275	1265	1313	1303	1295	1245					
"110"	-	-	-	1375	1365	1413	1403	-	-					
total height of the door frame with crown Hk [mm]														
"60" + "60"	1458	1498	1484	not applicable			1528	1518	not applicable					
"70" + "60"	1558	1598	1584				1628	1618						
"70" + "70"	1658	1698	1684				1728	1718						
"80" + "60"	1758	1798	1784				1828	1818						
"80" + "70"	1858	1898	1884				1928	1918						
"80" + "80"	1958	1998	1984				2028	2018						
"90" + "60"	2058	2098	2084				2128	2118						
"90" + "70"	2158	2198	2184				2228	2218						
"90" + "80"	2258	2298	2284				2328	2318						
"100" + "60"	2358	2398	2384				2428	2418						
total height of the door frame with crown Hk [mm]														
2148	2148	2136	2161	2156	2161	2156	2161	2136						

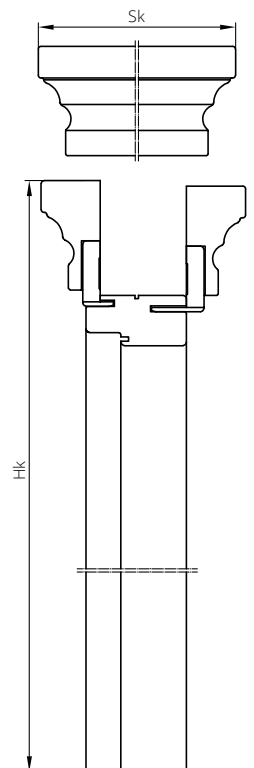

Sk - width on the outer side of the crown
Hk - height on the outer side of the crown

STRIPS

ECO TOP	UNI MAT PLUS		laminated CPL 0.2	PAINTED 9003	VENEERED		
	LAMISTONE CPL	SILKSTONE			GROUP A	GROUP B	GROUP C, D SILKWOOD REALWOOD



PRODUCT	ECO TOP	UNI MAT PLUS	laminated CPL 0.2	PAINTED 9003	GROUP A	GROUP B	GROUP C, D
OVAL STRIP LC1	LC1F	LC1F	LC1F	LC1F	LC10	LC10	LC10
single-leaf				-			
double-leaf door				-			



PRODUCT	ECO TOP	UNI MAT PLUS	laminated CPL 0.2	PAINTED 9003	GROUP A	GROUP B	GROUP C, D
MASKING STRIP LD6	LD6F	LD6F	LD6F	LD6F	LD60	LD60	LD60
single-leaf				-			
double-leaf door				-			



PRODUCT	ECO TOP	UNI MAT PLUS	laminated CPL 0.2	PAINTED 9003	GROUP A	GROUP B	GROUP C, D
MASKING STRIP LD10	LD10F	LD10F	LD10F	LD10F	LD100	LD100	LD100
single-leaf							
double-leaf door							

LD10 set for single-leaf door: 2 strips length 2200 mm + 1 strip length 1150 mm; set for double-leaf door: 3 strips length 2200 mm;
 LC1, LD6 set for single-leaf door: 2 strips length 2150 mm + 1 strip length 1150 mm; set for double-leaf door: 3 strips length 2150 mm

SKIRTING STRIPS

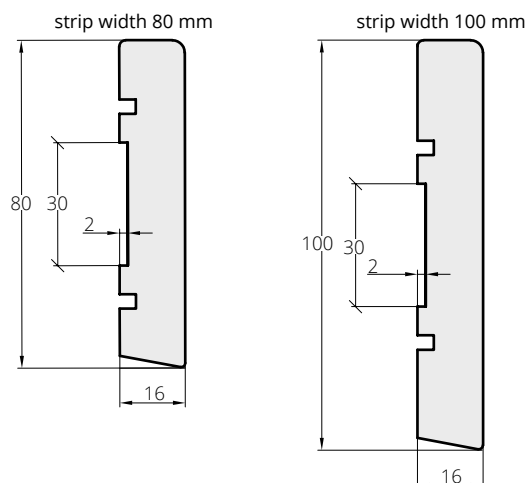

STRIP	PAINTED 9003	UNI MAT PLUS		VENEERED		
		LAMISTONE	SILKSTONE	GROUP A	GROUP B	GROUP C, D

price per 1 linear meter of strip

width 80 mm

width 100 mm

Skirting strips are made in elements with a length of 2.6 m.
 The minimum order quantity for one color is 5 elements (1 package).

thickness 16 mm



Strips in colors super white 213, Polish oak 276, merbau Royal 295 with a height of 80 mm are available from stock



ALU SKIRTING STRIPS

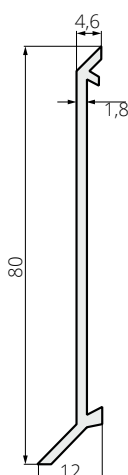

MODERN DESIGN

Ideal for the hidden door system HARMONY

Aluminum skirting strip with a height of 80 mm and a width of 12 mm, powder-coated in colors: RAL 9003, RAL 9005, RAL 7024, RAL 7047, beige NCS S 2005 Y50R, QL anodized or others from the RAL palette for extra charge (p. 311).

RAL 9003	RAL 9005	RAL 7024	RAL 7047	beige NCS S 2005 Y50R	MONO1*	MONO2*	ANODE QL
----------	----------	----------	----------	-----------------------	--------	--------	----------

price per 1 linear meter of strip

*except NCS

The strip is available in sections with a length of 2.45 m.
 Packed in sets of 5 pcs.
 Simple installation with mounting adhesive or double-sided tape.



door frame FIXED METAL POL-SKONE SYSTEM

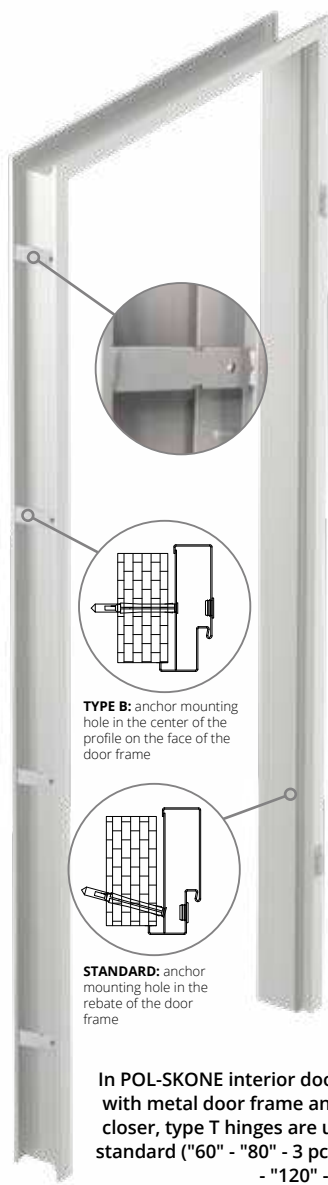

TYPE B: anchor mounting hole in the center of the profile on the face of the door frame

STANDARD: anchor mounting hole in the rebate of the door frame

DEDICATED TO

Interior doors

Metal door frames, depending on the type, made of sheet metal with a thickness of:

FD14 - thickness 1.5 mm
FD12 - thickness 1.5 mm

COLOR RANGE

Door frame painted with powder coating. Standard colors: white (RAL 9003), black (RAL 9005), white (RAL 9016), grey (RAL 7047), brown (RAL 8014), graphite (RAL 7024), beige (NCS S 2005 Y50R). Other colors according to RAL palettes available for extra charge - see extra charge table (p. 311)



	single-leaf door		double-leaf door	
type of door frame	"60"÷"80"	"90"÷"120"	"120"÷"150"	"160"÷"200"
FD14 small				
FD12 large				

EXTRA CHARGES

possibility to order mounting holes on the surface of the door frame (applies to FD12)

* for door leaves equipped with ECO Schulte GBS 12 lock extra charge

door frame shorter by 50 mm or 100 mm
door frame higher by 50 mm
door frame higher by 100 mm
door frame higher by 150 mm
door frame higher by 200 mm
stainless steel threshold for FD12 door frame - 1 pc.
reinforcement for surface door closer
additional hinge type M for metal door frame (width "60"- "80") - 1 pc.
additional visible hinge type M black
replacement of hinge with type T for metal door frame (width "60"- "80") - 1 pc.
fail-secure electric strike BIRA F12U (12V AC/DC) including strike plate and adaptation for electric strike*
fail-safe electric strike BIRA F12R (12V DC) including strike plate and adaptation for electric strike*
MC 250 flush-mounted reed switch
MC200-S19 mounting collar for reed switch (white color) (for metal door frames)

In POL-SKONE interior door leaves with metal door frame and door closer, type T hinges are used as standard ("60" - "80" - 3 pcs., "90" - "120" - 4 pcs.)

It is necessary to chisel the opening in the wall for the protective boxes.

S_d - width of the door on the outer side of the door frame
S_o - width of the installation opening
S_c - total width of the door frame

H_d - height of the door on the external side of the door frame
H_o - height of the installation opening
H_c - total height of the door frame

WIDTH FD14

	single-leaf door				double-leaf door			
type	S _o	S _d	S _c	type	S _o	S _d	S _c	
"60"	673	633	697	"120"	1307	1267	1331	
"70"	773	733	797	"130"	1407	1367	1431	
"80"	873	833	897	"140"	1507	1467	1531	
"80"plus	883	843	907	"150"	1607	1567	1631	
"90"	973	933	997	"160"	1707	1667	1731	
"90"plus	983	943	1007	"170"	1807	1767	1831	
"100"	1073	1033	1097	"180"	1907	1867	1931	
"110"	1173	1133	1197	"190"	2007	1967	2031	
"120"	1273	1233	1297	"200"	2107	2067	2131	

HEIGHT

	H _d	H _o	H _c
	2036	2046	2068

WIDTH FD12

	single-leaf door				double-leaf door			
type	S _o	S _d	S _c	type	S _o	S _d	S _c	
"60"	681	671	697	"120"	1315	1305	1331	
"70"	781	771	797	"130"	1415	1405	1431	
"80"	881	871	897	"140"	1515	1505	1531	
"80"plus	891	881	907	"150"	1615	1605	1631	
"90"	981	971	997	"160"	1715	1705	1731	
"90"plus	991	981	1007	"170"	1815	1805	1831	
"100"	1081	1071	1097	"180"	1915	1905	1931	
"110"	1181	1171	1197	"190"	2015	2005	2031	
"120"	1281	1271	1297	"200"	2115	2105	2131	

HEIGHT

	H _d	H _o	H _c
	2055	2060	2068

In the case of door frames equipped with an electric strike, it is necessary to increase the width of the installation opening by an additional 5 mm.

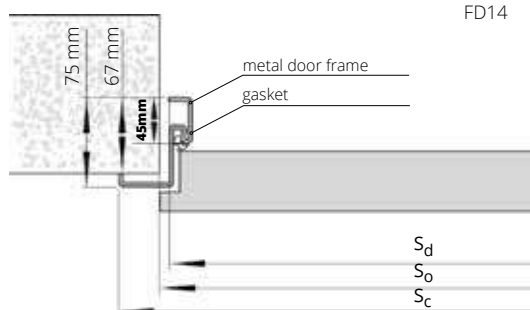

FD14

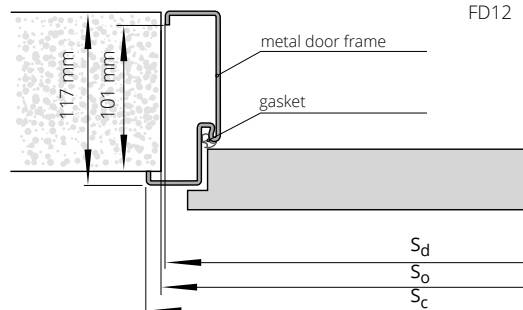

FD12



ITB-KOT-2021/2046 edition 1

door frame **FIXED** METAL DUO POL-SKONE SYSTEM



ATTENTION! The price of the METAL DUO door frame includes DUO concealed hinges.

DEDICATED TO
Interior doors

Non-rebated metal door frame adapted for DUO concealed hinges, made of sheet metal with a thickness of 1.5 mm.

COLOR RANGE
Door frame painted with powder coating. Standard colors: white (RAL 9003), black (RAL 9005), white (RAL 9016), grey (RAL 7047), brown (RAL 8014), graphite (RAL 7024), beige (NCS S 2005 Y50R). Other colors according to RAL palettes available for extra charge - see extra charge table (p. 311)



symbol	range in mm	single-leaf door			double-leaf door		
		"60"±"80"	"90"	"100"±"110"	"60"±"60", "60"±"70", "60"±"80", "70"±"70", "70"±"80"	"90"±"60"	"160"-"200"
FD93	101						
	number of concealed hinges	2 pcs.	3 pcs.	3 pcs.	4 pcs.	6 pcs.	6 pcs.

EXTRA CHARGES

- door frame shorter by 50 mm or 100 mm
- door frame higher by 50 mm
- door frame higher by 100 mm
- door frame higher by 150 mm
- door frame higher by 200 mm
- reinforcement for surface door closer
- reinforcement for concealed door closer GEZE BOXER 2-4; ITS 96 2-4
- DUO hinge for metal door frame (concealed) - 1 pc.
- BIRA electric strike with latch (reversible) F12R-C (12V DC) (including SPEC-727 strike plate and adaptation for electric strike)*
- BIRA electric strike with latch (non-reversible) F12U-C (12V AC/DC) (including SPEC-727 strike plate and adaptation for electric strike)*
- MC 250 flush-mounted reed switch
- MC200-S19 mounting collar for reed switch (white color) (for metal door frames)

*for door leafs equipped with ECO Schulte GBS 12 lock, extra charge

In the case of door frames equipped with an electric strike, it is necessary to increase the width of the installation opening by an additional 5 mm.

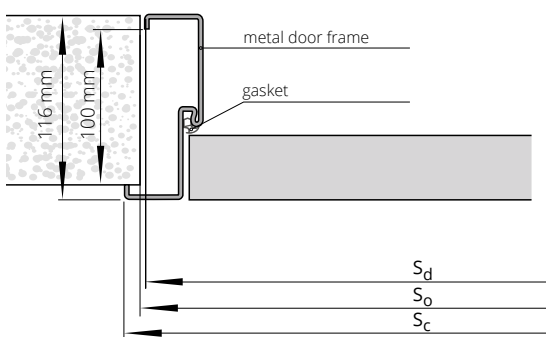

WIDTH										
type	single-leaf door			double-leaf door			type	S _O	S _D	S _C
	S _O	S _D	S _C	S _O	S _D	S _C				
"60"	685	676	702	"120"	1300	1290	1316			
"70"	785	776	802	"130"	1400	1390	1416			
"80"	885	876	902	"140"	1500	1490	1516			
"80"plus	910	901	927	"150"	1600	1590	1616			
"90"	985	976	1002	"160"	1700	1690	1716			
"90"plus	1010	1001	1027	"170"	1800	1790	1816			
"100"	1085	1076	1102	"180"	1900	1890	1916			
"110"	1185	1176	1202	"190"	2000	1990	2016			
				"200"	2100	2090	2116			
HEIGHT				H _O	H _C	H _D				
				2060	2068	2055				

S_d - width of the door on the external side of the door frame
S_o - width of the installation opening
S_c - total width of the door frame

H_d - height of the door on the external side of the door frame
H_o - height of the installation opening
H_c - total height of the door frame



door frame ADJUSTABLE METAL POL-SKONE SYSTEM



DEDICATED TO

Interior doors

Door frame made of sheet metal with a thickness of 1.5 mm.

COLOR RANGE

Door frame painted with powder coating. Standard colors: white (RAL 9003), black (RAL 9005), white (RAL 9016), gray (RAL 7047), brown (RAL 8014), graphite (RAL 7024), beige (NCS S 2005 Y50R). Other colors according to RAL palettes available for extra charge - see extra charge table (p. 311)

symbol	range mm	single-leaf door		double-leaf door	
		"60"±"80"	"90"±"120"	"120"±"150"	"160"±"200"
ZO1	95-125				
ZO2	125-155				
ZO3	155-185				
ZO4	185-215				
ZO5	215-245				
ZO6	245-275				
ZO7	275-305				
ZO8	305-335				
ZO9	335-365				

EXTRA CHARGES

door frame shorter by 50 mm or 100 mm
door frame higher by 50 mm
door frame higher by 100 mm
door frame higher by 150 mm
door frame higher by 200 mm
reinforcement for surface door closer
additional M hinge for metal door frame (width "60"- "80") - 1 pc.
additional visible hinge type M black
replacement of hinge with type T for metal door frame (width "60"- "80") - 1 pc.
fail-secure electric strike BIRA F12U (12V AC/DC) including strike plate and adaptation for electric strike*
fail-safe electric strike BIRA F12R (12V DC) including strike plate and adaptation for electric strike*
additional ZOx adjustment for adjustable rebated door frame (increasing the wall width range by 635 mm)
MC 250 flush-mounted reed switch
MC200-S19 mounting collar for magnetic contact (white color) (for metal door frames)

* for door leaves equipped with ECO Schulte GBS 12 lock extra charge

In POL-SKONE interior door leaves with metal door frame and door closer, type T hinges are used as standard ("60" - "80" - 3 pcs., "90" - "120" - 4 pcs.)

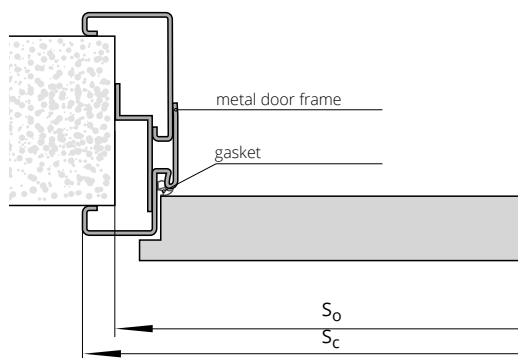

WIDTH									
single-leaf door					double-leaf door				
type	So	Sc	Ho	Hc	type	So	Sc	Ho	Hc
"60"	690	717			"120"	1325	1351		
"70"	790	817			"130"	1425	1451		
"80"	890	917			"140"	1525	1551		
"80" plus	900	927			"150"	1625	1651		
"90"	990	1017	2065	2078	"160"	1725	1751	2065	2078
"90" plus	1000	1027			"170"	1825	1851		
"100"	1090	1117			"180"	1925	1951		
"110"	1190	1217			"190"	2025	2051		
"120"	1290	1317			"200"	2125	2151		

So - width of the installation opening
Sc - total width of the door frame

Ho - installation opening height
Hc - total height of the door frame



ITB-KOT-2021/2046 edition 1

door frame ADJUSTABLE METAL DUO POL-SKONE SYSTEM

ATTENTION! The price of the METAL DUO door frame includes DUO concealed hinges.

DEDICATED TO

Interior doors

Non-rebated metal door frame adapted for concealed DUO hinges. Door frame made of 1.5 mm thick sheet metal.

COLOR RANGE

Door frame painted with powder coating. Standard colors: white (RAL 9003), black (RAL 9005), white (RAL 9016), gray (RAL 7047), brown (RAL 8014), graphite (RAL 7024), beige (NCS S 2005 Y50R). Other colors according to RAL palettes available for extra charge - see extra charge table (p. 311)



symbol	range in mm	single-leaf door			double-leaf door		
		"60" - "80"	"90"	"100" - "110"	"60"+"60", "60"+"70", "60"+"80", "70"+"70", "70"+"80"	"90"+"60"	"160"+"200"
F71	110-140						
F72	140-170						
F73	170-200						
F74	200-230						
F75	230-260						
F76	260-290						
F77	290-320						
F78	320-350						
F79	350-380						
number of concealed hinges		2 pcs.	3 pcs.	3 pcs.	4 pcs.	6 pcs.	6 pcs.

ATTENTION! The price includes DUO hinges for the metal door frame.

EXTRA CHARGES

door frame shorter by 50 mm or 100 mm

door frame higher by 50 mm

door frame higher by 100 mm

door frame higher by 150 mm

door frame higher by 200 mm

reinforcement for surface door closer

DUO hinge for metal door frame (concealed) - 1 pc.

BIRA electric strike with latch (reversible) F12R-C (12V DC) (including SPEC-727 strike plate and adaptation for electric strike)*

BIRA electric strike with latch (non-reversible) F12U-C (12V AC/DC) (including SPEC-727 strike plate and adaptation for electric strike)*

additional ZOZ adjustment for adjustable non-rebated door frame (increasing the wall width range by 650 mm)

MC 250 flush-mounted reed switch

MC200-S19 mounting collar for magnetic contact (white color) (for metal door frames)

*for door leaves equipped with ECO Schulte GBS 12 lock, extra charge

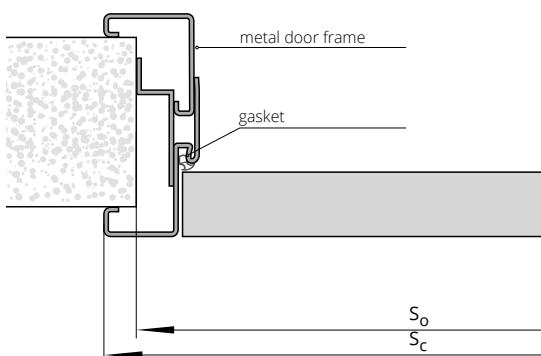

So - width of the installation opening
Sc - total width of the door frame

Ho - installation opening height
Hc - total height of the door frame

WIDTH						
type	single-leaf door			double-leaf door		
	S _c	S _o		type	S _c	S _o
"60"	721	693		"120"	1336	1308
"70"	821	793		"130"	1436	1408
"80"	921	893		"140"	1536	1508
"80"plus	946	918		"150"	1636	1608
"90"	1021	993		"160"	1736	1708
"90"plus	1046	1018		"170"	1836	1808
"100"	1121	1093		"180"	1936	1908
"110"	1221	1193		"190"	2036	2008
				"200"	2136	2108
HEIGHT				H _o	H _c	
				2065	2078	



door frame **FIXED**

METAL DIAGONAL POL-SKONE SYSTEM



DEDICATED TO

Interior doors

Door frame made of sheet metal with a thickness of 1.5 mm.

COLOR RANGE

Door frame painted with powder coating. Standard colors: white (RAL 9003), black (RAL 9005), white (RAL 9016), gray (RAL 7047), brown (RAL 8014), graphite (RAL 7024), beige (NCS S 2005 Y50R). Other colors according to RAL palettes available for extra charge - see extra charge table (p. 311)



single-leaf door		double-leaf door	
"60"÷"80"	"90"÷"120"	"120"÷"150"	"160"÷"200"
FD15 sheet thickness 1.5 mm			

EXTRA CHARGES

- door frame shorter by 50 mm or 100 mm
- door frame higher by 50 mm
- door frame higher by 100 mm
- door frame higher by 150 mm
- door frame higher by 200 mm
- reinforcement for surface door closer
- additional type M hinge for metal door frame (width "60"- "80") - 1 pc.
- replacement of hinge with type T for metal door frame (width "60"- "80") - 1 pc.
- fail-secure electric strike BIRA F12U (12V AC/DC) including strike plate and adaptation for electric strike*
- fail-safe electric strike BIRA F12R (12V DC) including strike plate and adaptation for electric strike*
- MC 250 flush-mounted reed switch
- MC200-S19 mounting collar for magnetic contact (white color) (for metal door frames)

* for door leaves equipped with ECO Schulte GBS 12 lock extra charge

In POL-SKONE interior door leaves with metal door frame and door closer, type T hinges are used as standard ("60" - "80" - 3 pcs., "90" - "120" - 4 pcs.)

Door frame made of the highest quality steel sheet with a thickness of 1.5 mm.

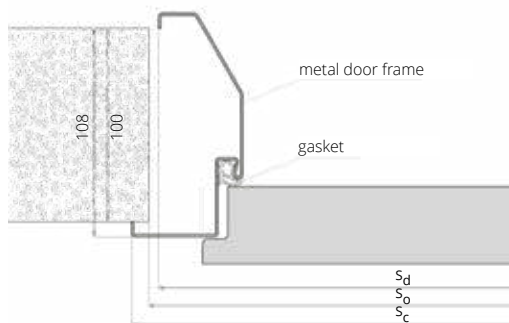

WIDTH								
single-leaf door				double-leaf door				
type	So	Sd	Sc	type	So	Sd	Sc	
"60"	700	691	717	"120"	1335	1325	1351	
"70"	800	791	817	"130"	1435	1425	1451	
"80"	900	891	917	"140"	1535	1525	1551	
"80" plus	910	901	927	"150"	1635	1625	1651	
"90"	1000	991	1017	"160"	1735	1725	1751	
"90" plus	1010	1001	1027	"170"	1835	1825	1851	
"100"	1100	1091	1117	"180"	1935	1925	1951	
"110"	1200	1191	1217	"190"	2035	2025	2051	
"120"	1300	1291	1317	"200"	2135	2125	2151	
HEIGHT				Ho	Hc	Hd		
				2069	2078	2065		

So - width of the installation opening
Sc - total width of the door frame
Sd - width on the external side of the door frame

Ho - height of the installation opening
Hd - height on the external side of the door frame
Hc - total height of the door frame



ITB-KOT-2021/2046 edition 1

door frame ADJUSTABLE METAL DIAGONAL POL-SKONE SYSTEM



In POL-SKONE interior door leaves with metal door frame and door closer, type T hinges are used as standard ("60" - "80" - 3 pcs., "90" - "120" - 4 pcs.)



DEDICATED TO
Interior doors

COLOR RANGE
Door frame painted with powder coating. Standard colors: white (RAL 9003), black (RAL 9005), white (RAL 9016), gray (RAL 7047), brown (RAL 8014), graphite (RAL 7024), beige (NCS S 2005 Y50R)
Other colors according to RAL palettes available for extra charge - see extra charge table (p. 311)

symbol	range in mm	single-leaf door		double-leaf door	
		"60"±"80"	"90" ± "120"	"120"±"150"	"160"±"200"
D01	125-155				
D02	155-185				
D03	185-215				
D04	215-245				
D05	245-275				
D06	275-305				
D07	305-335				
D08	335-365				

EXTRA CHARGES

- door frame shorter by 50 mm or 100 mm
- door frame higher by 50 mm
- door frame higher by 100 mm
- door frame higher by 150 mm
- door frame higher by 200 mm
- reinforcement for surface door closer
- additional type M hinge for metal door frame (width "60"."80") - 1 pc.
- replacement of hinge with type T for metal door frame (width "60"."80") - 1 pc.
- fail-secure electric strike BIRA F12U (12V AC/DC) including strike plate and adaptation for electric strike*
- fail-safe electric strike BIRA F12R (12V DC) including strike plate and adaptation for electric strike*
- MC 250 flush-mounted reed switch
- MC200-S19 mounting collar for magnetic contact (white color) (for metal door frames)

* for door leaves equipped with ECO Schulte GBS 12 lock extra charge

The door frame is made of the highest quality steel sheet with a thickness of 1.5 mm.

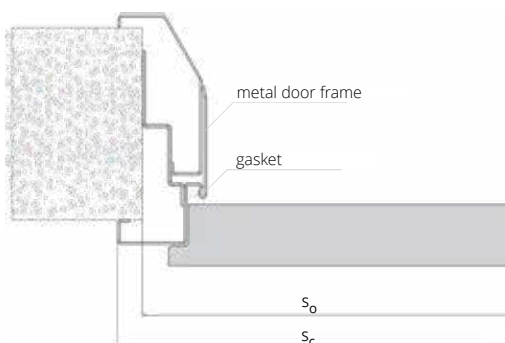

WIDTH									
type	single-leaf door				double-leaf door				
	So	Sc	Ho	Hc	type	So	Sc	Ho	Hc
"60"	690	717			"120"	1325	1351		
"70"	790	817			"130"	1425	1451		
"80"	890	917			"140"	1525	1551		
"80" plus	900	927			"150"	1625	1651		
"90"	990	1017	2065	2078	"160"	1725	1751	2065	2078
"90" plus	1000	1027			"170"	1825	1851		
"100"	1090	1117			"180"	1925	1951		
"110"	1190	1217			"190"	2025	2051		
"120"	1290	1317			"200"	2125	2151		

So - width of the installation opening
Sc - total width of the door frame

Ho - height of the installation opening
Hc - total height of the door frame



door frame **FIXED METAL LUMEN**



DEDICATED TO

LUMEN glass pane

Door frame made of sheet metal with a thickness of 1.5 mm.

COLOR RANGE

Door frame painted with powder coating. Standard colors: white (RAL 9003), black (RAL 9005), white (RAL 9016), gray (RAL 7047), brown (RAL 8014), graphite (RAL 7024), beige (NCS S 2005 Y50R). Other colors according to RAL palettes available for extra charge - see extra charge table (p. 311)



	single-leaf door
type of door frame	"60"-/90"
FD12 LUMEN	

EXTRA CHARGES

fail-safe electric strike BIRA F12U (12V AC/DC) including strike plate and adaptation for electric strike

fail-secure electric strike BIRA F12R (12V DC) including strike plate and adaptation for electric strike

For door frames equipped with an electric strike, it is necessary to increase the installation opening by an additional 5 mm.

FD12 LUMEN

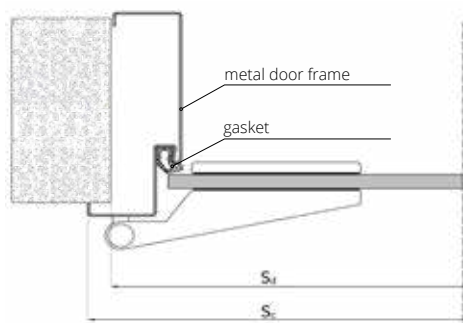

WIDTH FD12 LUMEN

	single-leaf door			
type	S _O	S _d	S _C	S _S
"60"	681	671	697	617
"70"	781	771	797	717
"80"	881	871	897	817
"90"	981	971	997	917

HEIGHT	H _d	H _O	H _C	H _S
	2055	2060	2068	2016

S_d - width of the door on the outer side of the door frame
S_O - width of the installation opening
S_C - total width of the door frame
S_S - width of the door leaf

H_d - height of the door on the external side of the door frame
H_O - height of the installation opening
H_C - total height of the door frame
H_S - height of the door leaf



ITB-KOT-2021/2046 edition 1

door frame ADJUSTABLE METAL LUMEN



DEDICATED TO

LUMEN glass pane

Door frame made of sheet metal with a thickness of 1.5 mm.

COLOR RANGE

Door frame painted with powder coating. Standard colors: white (RAL 9003), black (RAL 9005), white (RAL 9016), gray (RAL 7047), brown (RAL 8014), graphite (RAL 7024), beige (NCS S 2005 Y50R). Other colors according to RAL palettes available for extra charge - see extra charge table (p. 311)

symbol	range mm	single-leaf door "60"÷"90"
ZO1	95-125	
ZO2	125-155	
ZO3	155-185	
ZO4	185-215	
ZO5	215-245	
ZO6	245-275	
ZO7	275-305	
ZO8	305-335	
ZO9	335-365	

EXTRA CHARGES

additional ZOx adjustment for adjustable rebated door frame (increasing the wall width range by 635 mm)

fail-safe electric strike BIRA F12U (12V AC/DC) including strike plate and adaptation for electric strike

fail-secure electric strike BIRA F12R (12V DC) including strike plate and adaptation for electric strike

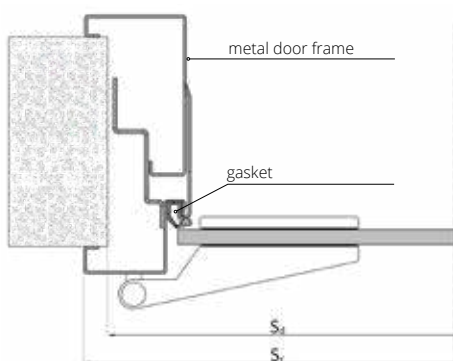

WIDTH FD61 LUMEN				
single-leaf door				
type	S _O	S _D	S _C	S _S
"60"	690	685	717	617
"70"	790	785	817	717
"80"	890	885	917	817
"90"	990	985	1017	917

HEIGHT	H _D	H _O	H _C	H _S
	2062	2065	2078	2016

S_d - width of the door on the outer side of the door frame
S_O - width of the installation opening
S_C - total width of the door frame
S_S - width of the door leaf

H_d - height of the door on the external side of the door frame
H_O - height of the installation opening
H_C - total height of the door frame
H_S - height of the door leaf



door frame **ADJUSTABLE** METAL FOR EI30 PLUS, EI60 PLUS DOORS

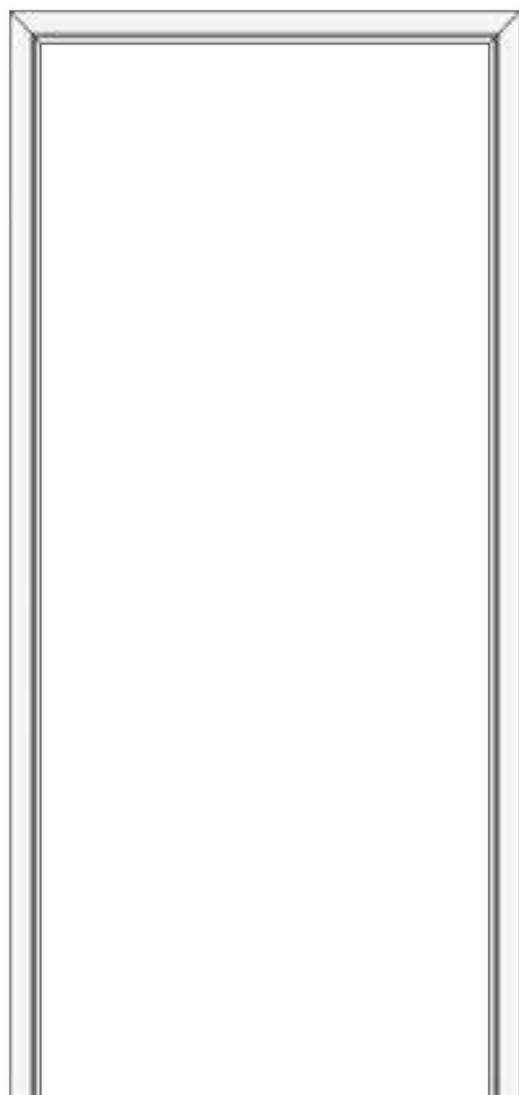

It is necessary to chisel an opening in the wall for the protective boxes.

The door frame is made of sheet metal with a thickness of 1.5 mm.

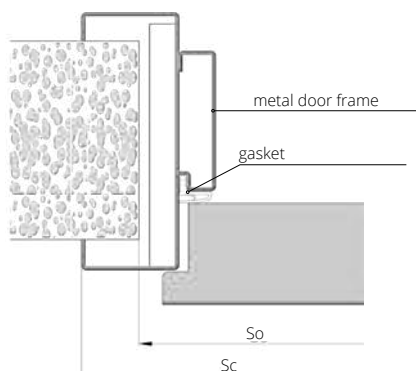

DEDICATED TO

Fire-resistant door leafs EI30 PLUS, EI60 PLUS

COLOR RANGE

Door frame painted with powder coating. Standard colors: white (RAL 9003), black (RAL 9005), white (RAL 9016), grey (RAL 7047), brown (RAL 8014), graphite (RAL 7024), beige (NCS S 2005 Y50R). Other colors according to RAL palettes available for extra charge - see extra charge table (p. 311)

symbol	range mm	single-leaf door EI30 PLUS (pp. 226-227)		
		"90"	"100"	"110"
S30	100-130			
S31	130-160			
S32	160-190			
S33	190-220			
S34	220-250			
S35	250-280			
S36	280-310			
S37	310-340			
S38	340-370			
S39	370-400			

for double-leaf door extra charge

symbol	range mm	single-leaf door EI60 PLUS (pp. 230-231)		
		"90"	"100"	"110"
S60	100-130			
S61	130-160			
S62	160-190			
S63	190-220			
S64	220-250			
S65	250-280			
S66	280-310			
S67	310-340			
S68	340-370			
S69	370-400			

for double-leaf door extra charge

EXTRA CHARGES

reinforcement for electric strike
reinforcement for concealed door closer GEZE BOXER 2-4; ITS 96 2-4; ITS 96 3-6
MC 250 flush-mounted reed switch
MC200-S19 mounting collar for magnetic contact (white color) (for metal door frames)

WIDTH

single-leaf door					double-leaf door				
type	So	Sc	Ho	Hc	type	So	Sc	Ho	Hc
"60"	665	724			"120"	1303	1362		
"70"	765	824			"130"	1403	1462		
"80"	865	924			"140"	1503	1562		
"90"	965	1024	2055	2081	"150"	1603	1662		
"90" plus	985	1044			"160"	1703	1762	2055	2081
"100"	1065	1124			"170"	1803	1862		
"110"	1165	1224			"180"	1903	1962		
					"190"	2003	2062		
					"200"	2103	2162		

* width 90 plus allows for a minimum clear opening of 900 mm when the door leaf is opened at an angle of 90°.

So - width of the installation opening Ho - installation opening height
Sc - total width of the door frame Hc - total height of the door frame



door frame ADJUSTABLE METAL DUO FOR EI30 PLUS, EI60 PLUS DOORS

DEDICATED TO

Fire-resistant door leaves EI30 PLUS, EI60 PLUS

COLOR RANGE

Door frame painted with powder coating. Standard colors: white (RAL 9003), black (RAL 9005), white (RAL 9016), gray (RAL 7047), brown (RAL 8014), graphite (RAL 7024), beige (NCS S 2005 Y50R). Other colors according to RAL palettes available for extra charge - see extra charge table (p. 311)

DUO metal door frames equipped with OBX ECO SCHULTE object hinges. TECTUS concealed hinges by Simonswerk for extra charge (p. 279)

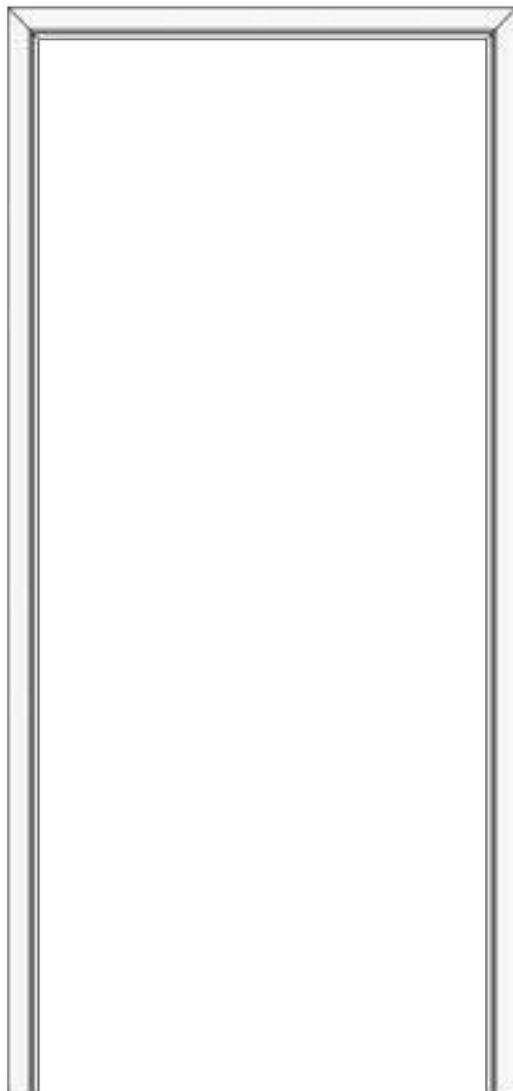

It is necessary to chisel an opening in the wall for the protective boxes.

symbol	range mm	single-leaf door EI30 PLUS (pp. 228-229)		
		"90"	"100"	"110"
D30	100-130			
D31	130-160			
D32	160-190			
D33	190-220			
D34	220-250			
D35	250-280			
D36	280-310			
D37	310-340			
D38	340-370			
D39	370-400			

for double-leaf door extra charge

symbol	range mm	single-leaf door EI60 PLUS (pp. 232-233)		
		"90"	"100"	"110"
D60	100-130			
D61	130-160			
D62	160-190			
D63	190-220			
D64	220-250			
D65	250-280			
D66	280-310			
D67	310-340			
D68	340-370			
D69	370-400			

for double-leaf door extra charge

EXTRA CHARGES

reinforcement for electric strike	
reinforcement for concealed door closer GEZE BOXER 2-4; ITS 96 2-4; ITS 96 3-6	
extra charge for hinges	p. 279
MC 250 flush-mounted reed switch	
MC200-S19 mounting collar for magnetic contact (white color) (for metal door frames)	

The door frame is made of sheet metal with a thickness of 1.5 mm.

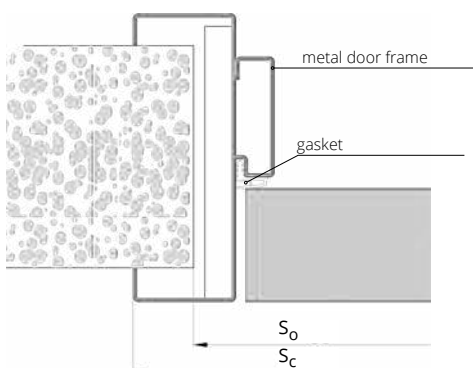

S_o - width of the installation opening
S_c - total width of the door frame
H_o - installation opening height
H_c - total height of the door frame

WIDTH					
single-leaf door			double-leaf door		
type	S _c	S _o	type	S _c	S _o
"60"	724	665	"120"	1340	1280
"70"	824	765	"130"	1440	1380
"80"	924	865	"140"	1540	1480
"90"	1024	965	"150"	1640	1580
"90"plus	1084	1025	"160"	1740	1680
"100"	1124	1065	"170"	1840	1780
"110"	1224	1165	"180"	1940	1880
			"190"	2040	1980
			"200"	2140	2080
HEIGHT					
			H _o	H _c	
			2055	2081	

* width 90 plus allows for a minimum clear opening of 900 mm when the door leaf is opened at an angle of 90°.



door frame **FIXED METAL** FOR EI30 PLUS, EI60 PLUS DOORS

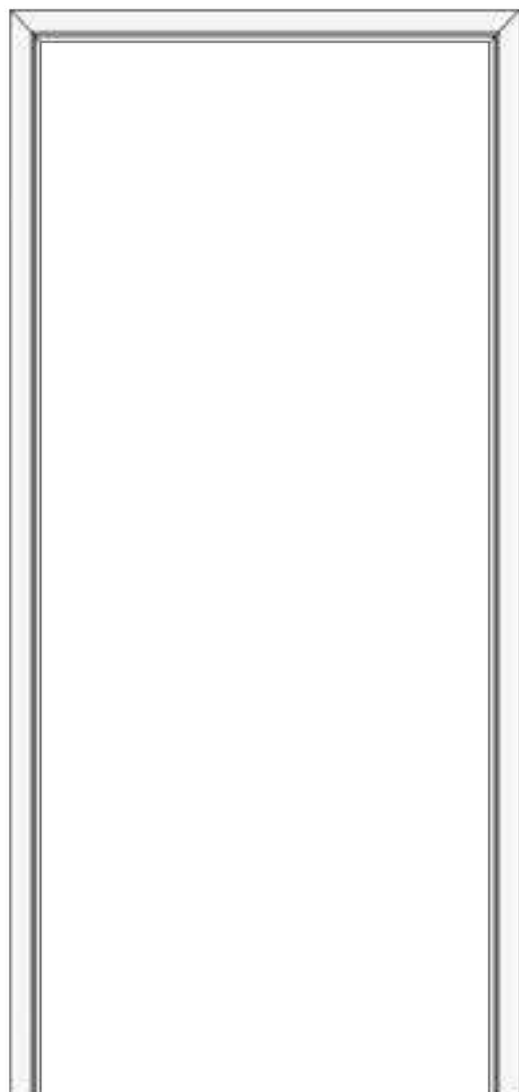

DEDICATED TO

Fire-resistant door leaves EI30 PLUS, EI60 PLUS

COLOR RANGE

Door frame painted with powder coating. Standard colors: white (RAL 9003), black (RAL 9005), white (RAL 9016), gray (RAL 7047), brown (RAL 8014), graphite (RAL 7024), beige (NCS S 2005 Y50R). Other colors according to RAL palettes available for extra charge - see extra charge table (p. 311)

symbol	range mm	single-leaf door EI30 PLUS (pp. 226-227)		
		"90"	"100"	"110"
UD EI30 PLUS	100			
standard range 100 mm width 100-150 mm available after consultation with the Sales Department				
for double-leaf door extra charge				

symbol	range mm	single-leaf door EI60 PLUS (pp. 230-231)		
		"90"	"100"	"110"
UD EI60 PLUS	100			
standard range 100 mm width 100-150 mm available after consultation with the Sales Department				
for double-leaf door extra charge				

EXTRA CHARGES

- reinforcement for electric strike
- reinforcement for concealed door closer GEZE BOXER 2-4; ITS 96 2-4; ITS 96 3-6
- MC 250 flush-mounted reed switch
- MC200-S19 mounting collar for magnetic contact (white color) (for metal door frames)

It is necessary to chisel an opening in the wall for the protective boxes.

The door frame is made of sheet metal with a thickness of 1.5 mm.

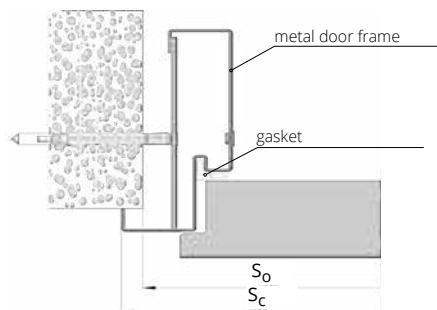

WIDTH									
single-leaf door					double-leaf door				
type	S _o	S _c	H _o	H _c	type	S _o	S _c	H _o	H _c
"60"	680	704			"120"	1320	1342		
"70"	780	804			"130"	1420	1442		
"80"	880	904			"140"	1520	1542		
"90"	980	1004	2060	2071	"150"	1620	1642		
"90" plus	1000	1024			"160"	1720	1742	2060	2071
"100"	1080	1104			"170"	1820	1842		
"110"	1180	1204			"180"	1920	1942		
					"190"	2020	2042		
					"200"	2120	2142		

* width 90 plus allows for a minimum clear opening of 900 mm when the door leaf is opened at an angle of 90°.

S_o - width of the installation opening H_o - installation opening height
S_c - total width of the door frame H_c - total height of the door frame



door frame **FIXED METAL DUO** FOR EI30 PLUS, EI60 PLUS DOORS

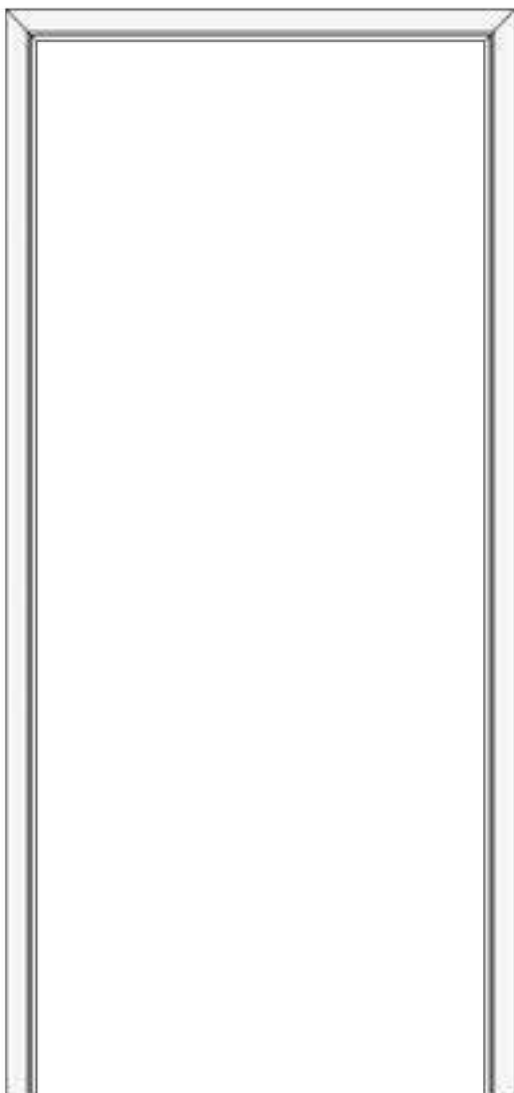

DEDICATED TO

Fire-resistant door leaves EI30 PLUS, EI60 PLUS

DUO metal door frames adapted for OBX ECO SCHULTE object hinges or for TECTUS concealed hinges by Simonswerk (option for extra charge) (p. 279)

COLOR RANGE

Door frame painted with powder coating. Standard colors: white (RAL 9003), black (RAL 9005), white (RAL 9016), gray (RAL 7047), brown (RAL 8014), graphite (RAL 7024), beige (NCS S 2005 Y50R) Other colors according to RAL palettes available for extra charge - see extra charge table (p. 311)

symbol	range mm	single-leaf door EI30 PLUS (pp. 228-229)		
		"90"	"100"	"110"
UD EI30 PLUS	100			
standard range 100 mm width 100-150 mm available after consultation with the Sales Department				
for double-leaf door extra charge				

symbol	range mm	single-leaf door EI60 PLUS (pp. 232-233)		
		"90"	"100"	"110"
UD EI60 PLUS	100			
standard range 100 mm width 100-150 mm available after consultation with the Sales Department				
for double-leaf door extra charge				

EXTRA CHARGES

reinforcement for electric strike	
reinforcement for concealed door closer GEZE BOXER 2-4; ITS 96 2-4; ITS 96 3-6	
extra charge for hinges	p. 279
MC 250 flush-mounted reed switch	
MC200-S19 mounting collar for magnetic contact (white color) (for metal door frames)	

It is necessary to chisel an opening in the wall for the protective boxes.

The door frame is made of sheet metal with a thickness of 1.5 mm.

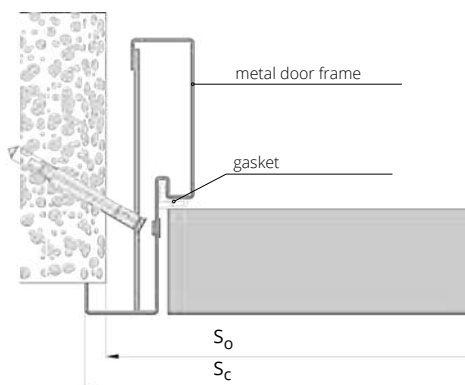

WIDTH					
single-leaf door			double-leaf door		
type	S_c	S_0	type	S_0	S_c
"60"	724	680	"120"	1296	1340
"70"	824	780	"130"	1396	1440
"80"	924	880	"140"	1496	1540
"90"	1024	980	"150"	1596	1640
"90"plus	1084	1040	"160"	1696	1740
"100"	1124	1080	"170"	1796	1840
"110"	1224	1180	"180"	1896	1940
			"190"	1996	2040
			"200"	2096	2140
HEIGHT			H_0	H_c	
			2060	2081	

* width 90 plus allows for a minimum clear opening of 900 mm when the door leaf is opened at an angle of 90°.

S_0 - width of the installation opening
 S_c - total width of the door frame

H_0 - installation opening height
 H_c - total height of the door frame



door frame ADJUSTABLE METAL G46 POL-SKONE SYSTEM



DEDICATED TO

G46 interior doors

Door frame made of sheet metal with a thickness of 1.5 mm.

COLOR RANGE

Door frame painted with powder coating. Standard colors: white (RAL 9003), black (RAL 9005), white (RAL 9016), gray (RAL 7047), brown (RAL 8014), graphite (RAL 7024), beige (NCS S 2005 Y50R). Other colors according to RAL palettes available for extra charge - see extra charge table (p. 311)



symbol	range mm	single-leaf door		double-leaf door	
		"60"±"80"	"90"±"100"	"120"±"150"	"160"±"200"
ZK1	101-131				
ZK2	131-161				
ZK3	161-191				
ZK4	191-221				
ZK5	221-251				
ZK6	251-281				
ZK7	281-311				
ZK8	311-341				
ZK9	341-371				

EXTRA CHARGES

door frame shorter by 50 mm or 100 mm

door frame higher by 50 mm

door frame higher by 100 mm

door frame higher by 150 mm

door frame higher by 200 mm

reinforcement for surface door closer

additional T hinge for metal door frame (width "90"- "100" with door closer) - 1 pc.

fail-secure electric strike BIRA F12U (12V AC/DC) including strike plate and adaptation for electric strike*

fail-secure electric strike BIRA F12R (12V DC) including strike plate and adaptation for electric strike*

additional ZOX adjustment for adjustable rebated door frame (increasing the wall width range by 635 mm)

MC 250 flush-mounted reed switch

MC200-S19 mounting collar for magnetic contact (white color) (for metal door frames)

* for door leaves equipped with ECO Schulte GBS 12 lock extra charge

In POL-SKONE interior door leaves with metal door frame and door closer, T-type hinges are used as standard ("60" - "80" - 3 pcs., "90" - "100" - 4 pcs.).

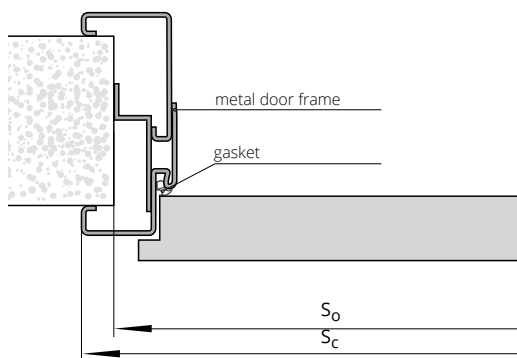

WIDTH

type	single-leaf door				double-leaf door				
	So	Sc	Ho	Hc	type	So	Sc	Ho	Hc
"60"	690	717			"120"	1325	1351		
"70"	790	817			"130"	1425	1451		
"80"	890	917			"140"	1525	1551		
"90"	990	1017			"150"	1625	1651		
"90" plus	1000	1027	2065	2078	"160"	1725	1751	2065	2078
"100"	1090	1117			"170"	1825	1851		
					"180"	1925	1951		
					"190"	2025	2051		
					"200"	2125	2151		

So - width of the installation opening
Sc - total width of the door frame

Ho - installation opening height
Hc - total height of the door frame



ADJUSTMENT SYSTEM

made of MDF for FIXED METAL DOOR FRAME

for entrance doors



Dedicated for:
 non-rebated metal door frame FD93
 rebated metal door frame FD12
 fixed metal door frame for RC3, RC3 INVEST doors
 fixed metal door frame for CERBER PLUS,
 CERBER PLUS RC2 doors

COLOR RANGE

Fixed metal door frame FD12, FD93, RC3, Cerber Plus: powder coated in RAL colors. Adjustment with MDF: ECO TOP, LAMISTONE, SILKSTONE, VENEERED GROUP A, B, C, D, SILKWOOD, REALWOOD.



single-leaf door			ECO TOP	UNI MAT PLUS LAMISTONE CPL SILKSTONE	laminated CPL 0.2	VENEERED		
symbol	range in mm (*)	GROUP A				GROUP B	GROUP C, D SILKWOOD REALWOOD	
MA1 MB1	175-195							
MA2 MB2	195-215							
MA3 MB3	215-235							
MA4 MB4	235-255							
MA5 MB5	255-275							
MA6 MB6	275-295							
MA7 MB7	295-315							
MA8 MB8	315-335							
MA9 MB9	335-355							
MA10 MB10	355-375							
MA11 MB11	375-395							
MA12 MB12	395-415							

EXTRA CHARGES

double-leaf door

(*) the adjustment range includes the thickness of the door frame FD12, CERBER PLUS, RC3, FD93
 MA: adjustments for FD12, CERBER PLUS, RC3
 MB: adjustments for FD93

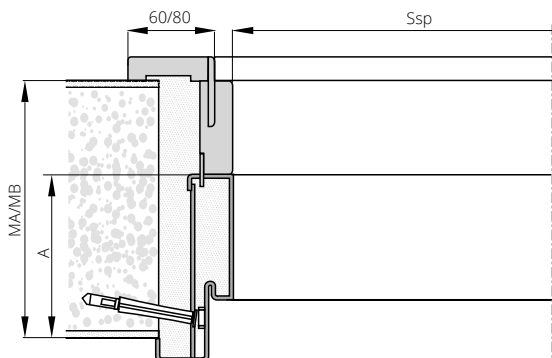

WIDTH (Ssp)

module	single-leaf door							
	FD12		CERBER PLUS CERBER PLUS RC2		RC3 RC3 INVEST		FD93	
	SopA	SopB	SopA	SopB	SopA	SopB	SopA	SopB
"60"	746	786	-	-	-	-	749	786
"70"	846	886	-	-	-	-	849	889
"80"	946	986	946	986	946	986	949	989
"90"	1046	1086	1046	1086	1046	1086	1049	1089
"90" Plus	1056	1096	1056	1096	1066	1106	1074	1114
"100"	1146	1186	1146	1186	1146	1186	1149	1189
"110"	1246	1286	-	-	-	-	1249	1289
A -	109		109		112		109	
HopA	2092				RC3 Invest - 2092		HopA - 2112	
HopB	2112				RC3 Invest - 2112		HopB - 2132	

SopA - width on the external side of trims 60 mm
 SopB - width on the external side of trims 80 mm
 HopA - height on the external side of trims 60 mm
 HopB - height on the external side of trims 80 mm

ADJUSTABLE DOOR FRAMES FOR ENTRANCE DOORS

FOR BURGLARY-RESISTANT DOORS B-30, C-30, CERBER PLUS, CERBER PLUS RC2, RC3

EXTRA CHARGE FOR A COMPLETE SET OF ADJUSTMENTS FOR BURGLARY-RESISTANT DOORS B-30, C-30, RC3, CERBER PLUS (WITH FLAT STRIPS - 60 mm), CERBER PLUS RC2 (ONE-SIDED GROOVING OF THE DOOR FRAME FOR INSTALLATION OF PANELS AND TRIMS)

symbol	range of adjustment	symbol of the door frame	degree of adjustment	UNI MAT PLUS	laminated CPL 0.2	LAMINATE EGGER CPL 0.2*	PAINTED 9003	MONO1 MAT	MONO2 MAT	VENEERED		
				LAMISTONE CPL						SILKSTONE	GROUP A	GROUP B
ZC 1	92-112	ZB1	100-120									
ZC 2	112-136	ZB2	120-144									
ZC 3	136-180	ZB3	144-188									
ZC 4	180-202	ZB4	188-210									
ZC 5	202-246	ZB5	210-254									
ZC 6	246-268	ZB6	254-276									
ZC 7	268-312	ZB7	276-320									
ZC 8	312-334	ZB8	320-342									
ZC 9	334-378	ZB9	342-386									
ZC 10	378-402	ZB10	386-410									
ZC11	402-420	ZB11	410-429									
ZC12	420-466	ZB12	429-476									
ZC13	466-486	ZB13	476-495									
ZC14	486-532	ZB14	495-542									
ZC15	532-552	ZB15	542-561									
ZC16	552-592	ZB16	561-608									

color range MONO3 MAT (extra charge for the basic color RAL 9003)

for door frames with dimensions other than standard (extra charge for each dimensional module)

trims and strips with a width of 60 mm, trims joined at a 45° angle (version A) - standard

trims and strips with a width of 60 mm, trims joined at a 90° angle (version D)

trims and strips with a width of 80 mm, trims joined at a 45° angle (version B)

trims and strips with a width of 80 mm, trims joined at a 90° angle (version C)

* only with 80 mm trims

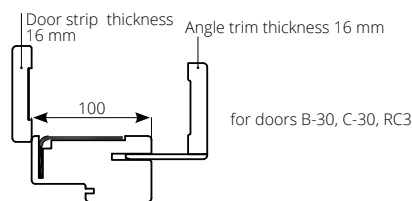

symbol	adjustment range	COMPLETION
ZB1	100-120	Door frame 100 mm, strip, trim 32 mm
ZB2	120-144	Door frame 100 mm, strip, trim 52 mm

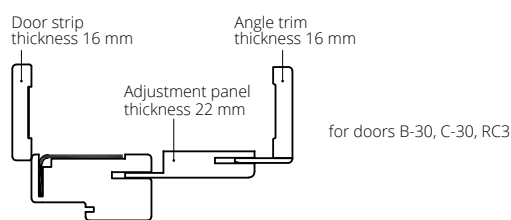

symbol	adjustment range	COMPLETION
ZB3	144-188	Door frame 100 mm, strip, trim 32 mm, panel 76 mm
ZB4	188-210	Door frame 100 mm, strip, trim 52 mm, panel 76 mm
ZB5	210-254	Door frame 100 mm, strip, trim 32 mm, panel 142 mm
ZB6	254-276	Door frame 100 mm, strip, trim 52 mm, panel 142 mm
ZB7	276-320	Door frame 100 mm, strip, trim 32 mm, panel 208 mm
ZB8	320-342	Door frame 100 mm, strip, trim 52 mm, panel 208 mm
ZB9	342-386	Door frame 100 mm, strip, trim 32 mm, panel 274 mm
ZB10	386-410	Door frame 100 mm, strip, trim 52 mm, panel 274 mm

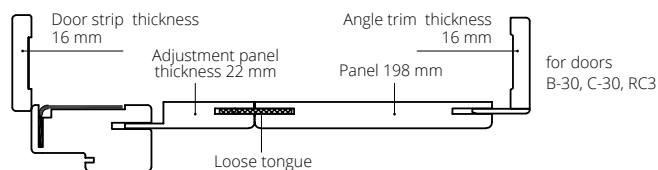

symbol	adjustment range	COMPLETION
ZB11	410-429	Door frame 100 mm, strip, trim 32 mm, panel 142+198 mm
ZB12	429-476	Door frame 100 mm, strip, trim 52 mm, panel 142+198 mm
ZB13	476-495	Door frame 100 mm, strip, trim 32 mm, panel 208+198 mm
ZB14	495-542	Door frame 100 mm, strip, trim 52 mm, panel 208+198 mm
ZB15	542-561	Door frame 100 mm, strip, trim 32 mm, panel 274+198 mm
ZB16	561-608	Door frame 100 mm, strip, trim 52 mm, panel 274+198 mm

for CERBER PLUS door leaves, CERBER PLUS RC2 door leaves

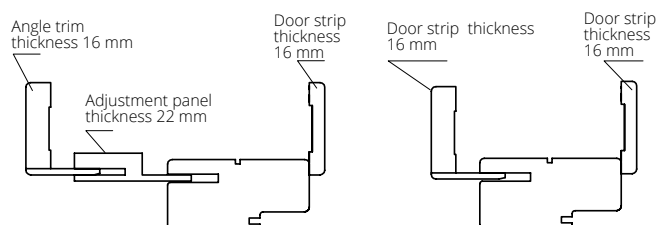

symbol	adjustment range	COMPLETION
ZC 1	92-112	Door frame 92 mm, door strip, trim 32 mm
ZC 2	112-136	Door frame 92 mm, door strip, trim 52 mm
ZC 3	136-180	Door frame 92 mm, door strip, trim 32 mm, panel 76 mm
ZC 4	180-202	Door frame 92 mm, door strip, trim 52 mm, panel 76 mm
ZC 5	202-246	Door frame 92 mm, door strip, trim 32 mm, panel 142 mm
ZC 6	246-268	Door frame 92 mm, door strip, trim 52 mm, panel 142 mm
ZC 7	268-312	Door frame 92 mm, door strip, trim 32 mm, panel 208 mm
ZC 8	312-334	Door frame 92 mm, door strip, trim 52 mm, panel 208 mm
ZC 9	334-378	Door frame 92 mm, door strip, trim 32 mm, panel 274 mm
ZC 10	378-402	Door frame 92 mm, door strip, trim 52 mm, panel 274 mm

WOODEN DOOR FRAMES FOR TECHNICAL DOOR LEAFS

ZF: for FR E130 door leaves

ZB: for E130 PLUS, B-30, C-30, RC3, SR 37 dB door leaves

ZA: for E160 PLUS door leaves

symbol	adjustment range	symbol	adjustment range	completion
ZF1	100-108	ZB1	100-120	door frame 100 mm, trim 32 mm
ZF2	108-132	ZB2	120-144	door frame 100 mm, trim 52 mm

symbol	adjustment range	symbol	adjustment range	completion
ZF3	132-176	ZB3	144-188	door frame 100 mm, strip, trim 32 mm, panel 76 mm
ZF4	176-198	ZB4	188-210	door frame 100 mm, strip, trim 52 mm, panel 76 mm
ZF5	198-242	ZB5	210-254	door frame 100 mm, strip, trim 32 mm, panel 142 mm
ZF6	242-264	ZB6	254-276	door frame 100 mm, strip, trim 52 mm, panel 142 mm
ZF7	264-308	ZB7	276-320	door frame 100 mm, strip, trim 32 mm, panel 208 mm
ZF8	308-330	ZB8	320-342	door frame 100 mm, strip, trim 52 mm, panel 208 mm
ZF9	330-374	ZB9	342-386	door frame 100 mm, strip, trim 32 mm, panel 274 mm
ZF10	374-398	ZB10	386-410	door frame 100 mm, strip, trim 52 mm, panel 274 mm

symbol	adjustment range	symbol	adjustment range	completion
ZF11	398-417	ZB11	410-429	door frame 100 mm, strip, trim 32 mm, panel 142+198 mm
ZF12	417-464	ZB12	429-476	door frame 100 mm, strip, trim 52 mm, panel 142+198 mm
ZF13	464-483	ZB13	476-495	door frame 100 mm, strip, trim 32 mm, panel 208+198 mm
ZF14	483-530	ZB14	495-542	door frame 100 mm, strip, trim 52 mm, panel 208+198 mm
ZF15	530-548	ZB15	542-560	door frame 100 mm, strip, trim 32 mm, panel 274+198 mm
ZF16	548-593	ZB16	560-605	door frame 100 mm, strip, trim 52 mm, panel 274+198 mm

1	symbol	adjustment range	completion
	ZA1	120-140	door frame 120 mm, strip, trim 32 mm
	ZA2	140-164	door frame 120 mm, strip, trim 52 mm

2	symbol	adjustment range	completion
	ZA3	164-208	door frame 120 mm, strip, trim 32 mm
	ZA4	208-230	door frame 120 mm, strip, trim 52 mm, panel 76 mm
	ZA5	230-274	door frame 120 mm, strip, trim 32 mm, panel 142 mm
	ZA6	274-296	door frame 120 mm, strip, trim 52 mm, panel 142 mm
	ZA7	296-340	door frame 120 mm, strip, trim 32 mm, panel 208 mm
	ZA8	340-362	door frame 120 mm, strip, trim 52 mm, panel 208 mm
	ZA9	362-406	door frame 120 mm, strip, trim 32 mm, panel 274 mm
	ZA10	406-430	door frame 120 mm, strip, trim 52 mm, panel 274 mm

3	symbol	adjustment range	completion
	ZA11	430-449	door frame 120 mm, strip, trim 32 mm, panel 142+198 mm
	ZA12	449-496	door frame 120 mm, strip, trim 52 mm, panel 142+198 mm
	ZA13	496-515	door frame 120 mm, strip, trim 32 mm, panel 208+198 mm
	ZA14	515-562	door frame 120 mm, strip, trim 52 mm, panel 208+198 mm
	ZA15	562-580	door frame 120 mm, strip, trim 32 mm, panel 274+198 mm
	ZA16	580-625	door frame 120 mm, strip, trim 52 mm, panel 274+198 mm

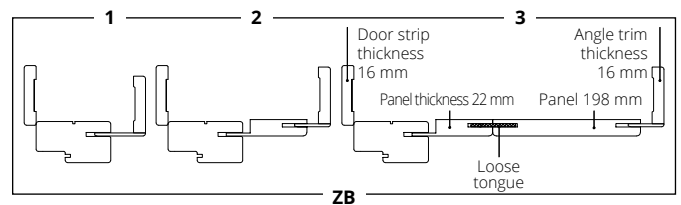
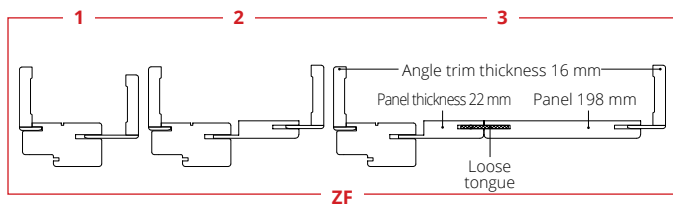

For single-leaf door CERBER PLUS, CERBER PLUS 37 dB, GAMMA

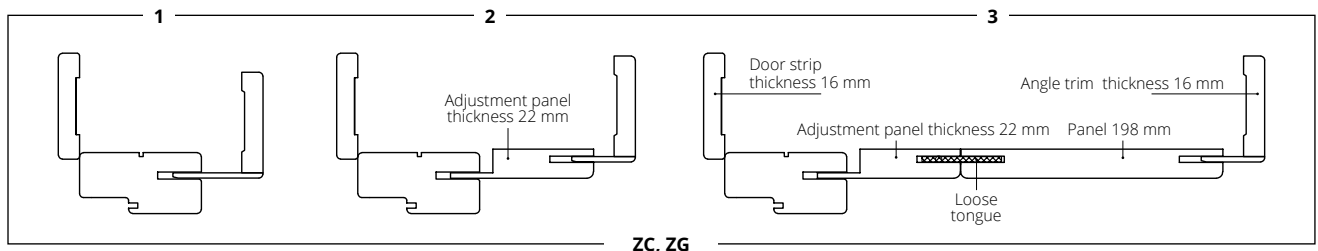

1	symbol	adjustment range	completion
	ZC1, ZG1	92-112	door frame 92 mm, strip, trim 32 mm
	ZC2, ZG2	112-136	door frame 92 mm, strip, trim 52 mm

2	symbol	adjustment range	completion
	ZC3, ZG3	136-180	door frame 92 mm, strip, trim 32 mm, panel 76 mm
	ZC4, ZG4	180-202	door frame 92 mm, strip, trim 52 mm, panel 76 mm
	ZC5, ZG5	202-246	door frame 92 mm, strip, trim 32 mm, panel 142 mm
	ZC6, ZG6	246-268	door frame 92 mm, strip, trim 52 mm, panel 142 mm
	ZC7, ZG7	268-312	door frame 92 mm, strip, trim 32 mm, panel 208 mm
	ZC8, ZG8	312-334	door frame 92 mm, strip, trim 52 mm, panel 208 mm
	ZC9, ZG9	334-378	door frame 92 mm, strip, trim 32 mm, panel 274 mm
	ZC10, ZG10	378-402	door frame 92 mm, strip, trim 52 mm, panel 274 mm

3	symbol	adjustment range	completion
	ZC11, ZG11	402-421	door frame 92 mm, strip, trim 32 mm, panel 142+198 mm
	ZC12, ZG12	421-468	door frame 92 mm, strip, trim 52 mm, panel 142+198 mm
	ZC13, ZG13	468-487	door frame 92 mm, strip, trim 32 mm, panel 208+198 mm
	ZC14, ZG14	487-534	door frame 92 mm, strip, trim 52 mm, panel 208+198 mm
	ZC15, ZG15	534-553	door frame 92 mm, strip, trim 32 mm, panel 274+198 mm
	ZC16, ZG16	553-600	door frame 92 mm, strip, trim 52 mm, panel 274+198 mm

It is possible to create a non-standard construction after consultation with the Sales Department.

EXTRA CHARGE FOR A SET OF ADJUSTMENTS FOR FIRE DOORS WITH A FIXED DOOR FRAME

for single-leaf door

symbol of the door frame	adjustment range [mm]	symbol door frame*	adjustment range [mm]	LAMISTONE	LAMINATED CPL 0.2	EGGER CPL 0.2 LAMINATE	PAINTED 9003	MONO1 MAT	MONO2 MAT	VENEERED		
				SILKSTONE						GROUP A	GROUP B	GROUP C, D, SILKWOOD, REALWOOD
				UNI MAT PLUS								
ZB1	100-120	ZA1	120-140									
ZB2	120-144	ZA2	140-164									
ZB3	144-188	ZA3	164-208									
ZB4	188-210	ZA4	208-230									
ZB5	210-254	ZA5	230-274									
ZB6	254-276	ZA6	274-296									
ZB7	276-320	ZA7	296-340									
ZB8	320-342	ZA8	340-362									
ZB9	342-386	ZA9	362-406									
ZB10	386-410	ZA10	406-430									
ZB11	410-429	ZA11	430-449									
ZB12	429-476	ZA12	449-496									
ZB13	476-495	ZA13	496-515									
ZB14	495-542	ZA14	515-562									
ZB15	542-561	ZA15	562-581									
ZB16	561-608	ZA16	581-628									

extra charge for door frames with dimensions other than standard (extra charge for each dimensional module) double-leaf door * applies to EI60 PLUS doors

color range MONO3 MAT (extra charge for basic color RAL 9003)

trims and strips with a width of 60 mm, trims joined at a 45° angle (version A) - standard

trims and strips with a width of 60 mm, trims joined at a 90° angle (version D)

trims and strips with a width of 80 mm, trims joined at a 45° angle (version B)

trims and strips with a width of 80 mm, trims joined at a 90° angle (version C)

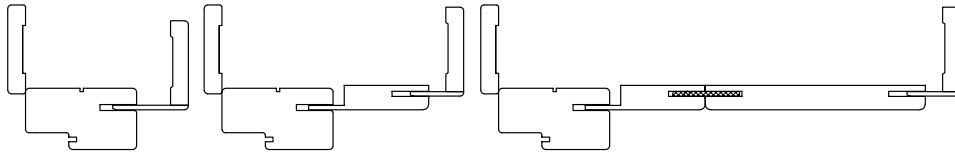

EXTRA CHARGE FOR A SET OF DOUBLE-SIDED ADJUSTMENTS FOR EI30 FIRE DOORS POLSKONE SYSTEM, SR 37 dB, SR 42 dB

for single-leaf door

symbol of the door frame	adjustment range [mm]	UNI MAT PLUS	LAMINATED CPL 0.2	EGGER CPL 0.2 LAMINATE	PAINTED 9003	MONO1 MAT	MONO2 MAT	VENEERED		
		LAMISTONE						GROUP A	GROUP B	GROUP C, D, SILKWOOD, REALWOOD
		SILKSTONE								
ZF1	100-108									
ZF2	108-132									
ZF3	132-176									
ZF4	176-198									
ZF5	198-242									
ZF6	242-264									
ZF7	264-308									
ZF8	308-330									
ZF9	330-374									
ZF10	374-398									
ZF11	398-417									
ZF12	417-464									
ZF13	464-483									
ZF14	483-530									
ZF15	530-548									
ZF16	548-593									

double-leaf door

for door frames with dimensions other than standard (extra charge for each dimensional module)

color range MONO3 MAT (extra charge for basic color RAL 9003)

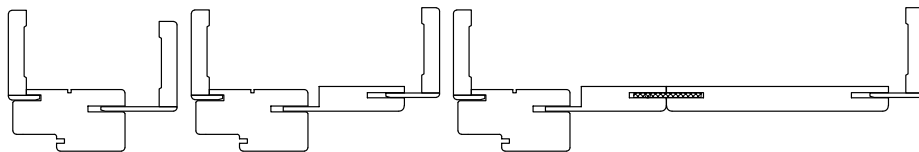

EXTRA CHARGES FOR NON-STANDARD DIMENSIONS OF ADJUSTMENT SETS

standard height	standard width	non-standard width "100"	non-standard width "110"
non-standard height up to 2200 mm	-	extra charge	extra charge
non-standard height up to 2300 mm	extra charge	extra charge	extra charge
non-standard height up to 2400 mm	extra charge	extra charge	extra charge
non-standard height up to 2500 mm	extra charge	extra charge	extra charge

EXTRA CHARGES FOR CHANGING THE VERTICAL ELEMENT FROM STANDARD TO A TRIM WITH A WIDTH OF 150 MM, 180 MM, AND 210 MM (FOR DOORS B-30, C-30, RC3, CERBER PLUS, EI30 PLUS, EI60 PLUS, EI30)

architrave 150 mm, 180 mm and 210 mm	LAMISTONE CPL	LAMINATED CPL 0.2	PAINTED 9003	MONO1 MAT	MONO2 MAT	VENEERED GROUP A	VENEERED GROUP B	VENEERED GROUP C, D REALWOOD
tongue 12 mm	SILKSTONE							
tongue 32 mm								
tongue 52 mm								

WALL PANELS

Wall panels can be used as a durable wall cladding in offices, conference rooms, residential spaces, studies, or public utility buildings. The rich color range allows for matching the appropriate decor to the room and the door joinery of the building.



1. Wall panels are made of 16 mm thick MDF board, double-sided covered with a decorative layer.
2. Wall panels classified as flame-retardant according to PN-EN 13501-1+A1:2010 are made of 16 mm thick MDF board with fire reaction class Bs1 d0, double-sided covered with a decorative layer.



NRO WALL PANELS

ECO TOP	SILKSTONE	LAMISTONE	PAINTED RAL 9003	VENEERED GROUP A	VENEERED GROUP B	VENEERED GROUP C, D REALWOOD
---------	-----------	-----------	------------------	------------------	------------------	------------------------------



NRO panels classified as flame-retardant

price per 1 m² (exact panel dimensions available after consultation with the Sales Department)

WALL PANELS

ECO TOP	SILKSTONE	UNI MAT PLUS	LAMISTONE	CPL LAMINATE 0.2 mm	SILKSTONE CPL 0.5 mm
---------	-----------	--------------	-----------	---------------------	----------------------

PAINTED RAL 9003	MONO1 MAT	MONO2 MAT	MONO3	VENEERED GROUP A	VENEERED GROUP B	VENEERED GROUP C, D REALWOOD
------------------	-----------	-----------	-------	------------------	------------------	------------------------------

price per 1 m² (exact panel dimensions available after consultation with the Sales Department)

DIMENSIONS

Laminated panels for doors with flush and stile and rail construction:
Dimensions: max. width: 1100 mm, max. height: 2500 mm

Veneered panels for doors with flush and stile and rail construction:
Dimensions: max. width: 1100 mm, max. height: 2500 mm

FINISH

Veneered surface, covered with LAMISTONE, SILKSTONE, ECO TOP laminate, painted or CPL laminate.
Grain direction of panels up to 1100 mm wide – vertical or horizontal.
Grain direction of panels over 1100 mm wide – only horizontal grain.

INSTALLATION

Specialist assembly adhesive.

minimum width of wall panel 100 mm

Dimensions: max. width: 1100 mm, max. height: 2500 mm
extra charge for dimensions 2301-2500 mm to the price per m²
extra charge for dimensions 80-299 mm to the price per m²

for veneered panels with a height of 2200-2500 mm, it is possible to join the veneer with micro-dovetail.

GROOVED WALL PANELS

Panels made of board with **increased resistance** to moisture. Panel with dimensions 145 mm x 2700 mm x thickness 16 mm. Color range **LAMISTONE**: white 213, oak terra 250, oak natura 234; **SILKSTONE**: Polish oak 276, gran oak 230; **UNI MAT PLUS** Panel for self-assembly (tongue and groove method).



price per 1 piece grooved panel

LAMISTONE	SILKSTONE	UNI MAT PLUS
-----------	-----------	--------------

Grooved wall panels ordered in multiples of 5 pieces.

To assemble the wall, please additionally order:
Starting profile
End profile



NON-STANDARD STRUCTURES WITH ARCHITRAVES

FOR CERBER PLUS, CERBER PLUS RC2, B-30, C-30, RC3, EI30 POL-SKONE SYSTEM, EI30 PLUS, EI60 PLUS, SR37 DOORS

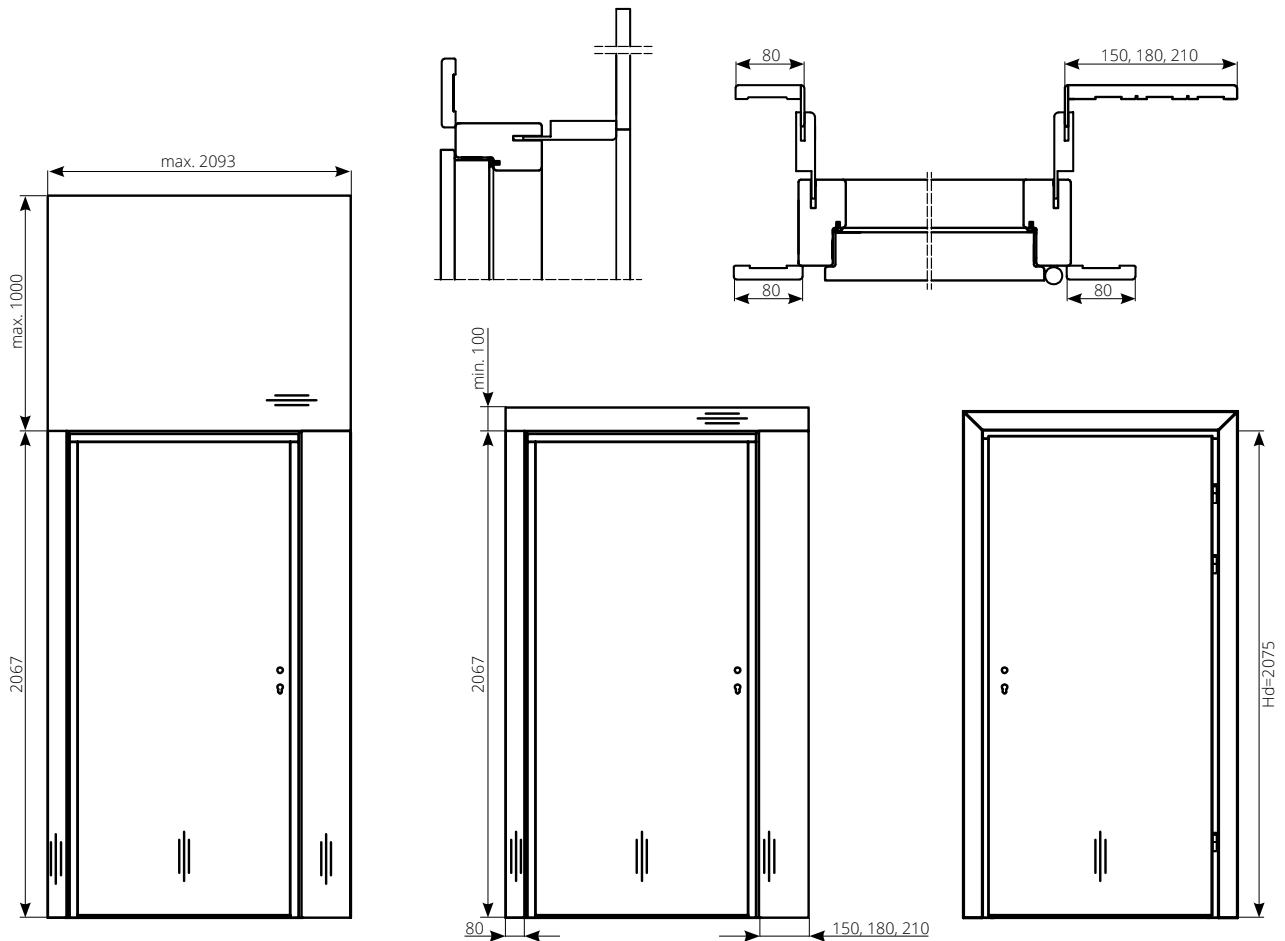

Top panel up to 1220 mm wide can be made with vertical or horizontal grain direction.
 Top panel over 1220 mm wide only with horizontal grain direction.
 Top veneered panel can be made with vertical or horizontal grain direction.
 Possibility of 90° connection – version C

PANEL HOUSING WITH CASINGS (adjustment panel 22 mm + strip 80 mm + vertical casings 80 mm) - without upper wall panel

for single-leaf door			LAMISTONE CPL	laminated CPL 0.2	LAMINATE EGGER CPL 0.2	PAINTED 9003	MONO1 MAT	MONO2 MAT	VENEERED		
B-30, C-30, RC3, SR37, EI30 SYSTEM POL-SKONE, EI30 PLUS	CERBER PLUS, CERBER PLUS RC2	EI60 PLUS	SILKSTONE						GROUP A	GROUP B	GROUP C, D REALWOOD
symbol range [mm]	symbol range [mm]	symbol range [mm]	UNI MAT PLUS								
FY1 144-169	FU1 136-161	FW1 164-189									
FY2 169-194	FU2 161-186	FW2 189-214									
FY3 194-219	FU3 186-211	FW3 214-239									
FY4 219-244	FU4 211-236	FW4 239-264									
FY5 244-269	FU5 236-261	FW5 264-289									
FY6 269-294	FU6 261-286	FW6 289-314									
FY7 294-319	FU7 286-311	FW7 314-339									
FY8 319-344	FU8 311-336	FW8 339-364									
FY9 344-369	FU9 336-361	FW9 364-389									

color range MONO3 MAT (extra charge for basic color RAL 9003)

casings joined at an angle of 90° – door strip cut at an angle of 90°

FU - HOUSING FOR CERBER PLUS DOOR, CERBER PLUS RC2

FY - HOUSING FOR B-30, C-30, RC3, EI30 SYSTEM POL-SKONE, EI30 PLUS, SR 37 dB DOOR

FW - HOUSING FOR EI60 PLUS DOOR

HOUSING PRICE = HOUSING PRICE WITH CASINGS + UPPER PANEL PRICE [m²] - p. 271

NON-STANDARD HOUSINGS WITH PANEL

FOR CERBER PLUS DOOR, CERBER PLUS RC2, B-30, C-30, RC3, EI30 SYSTEM POL-SKONE, EI30 PLUS, EI60 PLUS, SR37

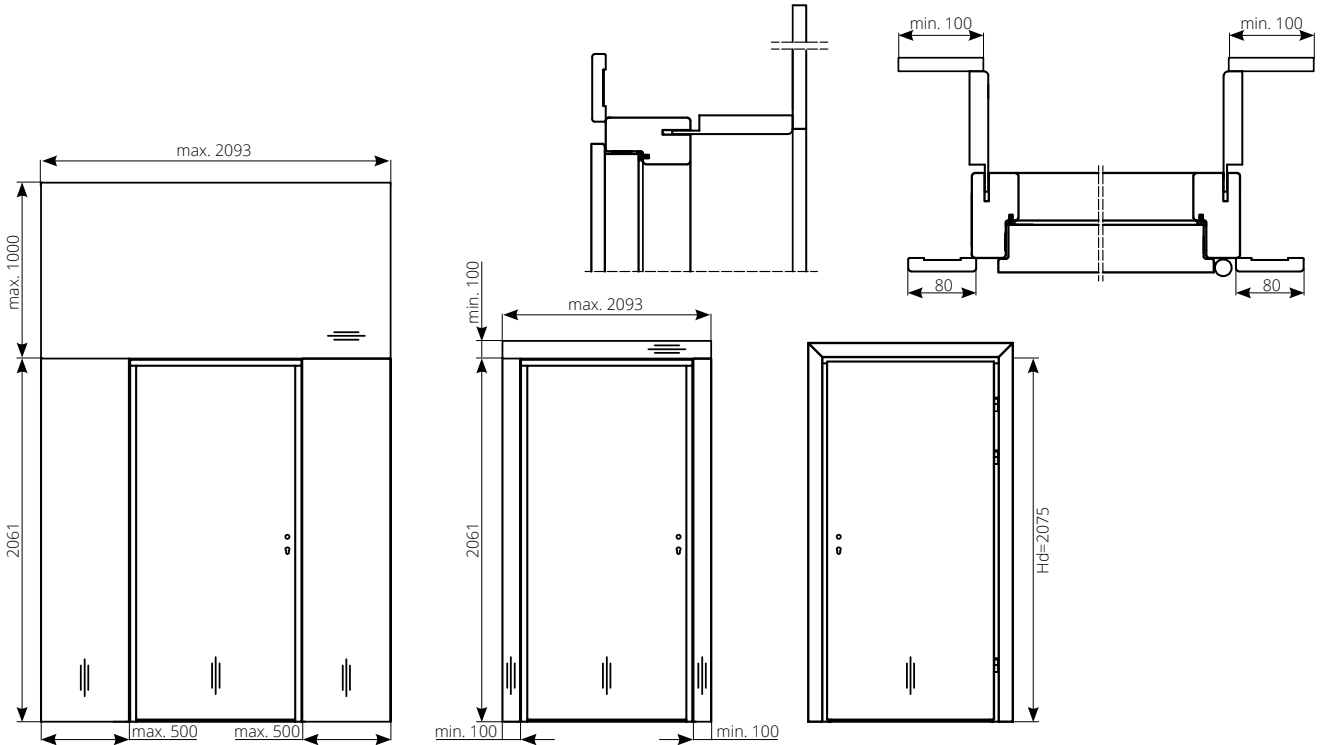

Top panel up to 1220 mm wide can be made with vertical or horizontal grain direction.
 Top panel over 1220 mm wide only with horizontal grain direction.
 Top veneered panel can be made with vertical or horizontal grain direction.

PANEL HOUSING (adjustment panel 22 mm + strip 80 mm) - without wall panels

B-30, C-30, RC3, SR37, EI30 SYSTEM POL-SKONE, EI30 PLUS	CERBER PLUS, CERBER PLUS RC2	EI60 PLUS	LAMISTONE CPL	LAMINATE CPL 0.2	LAMINATE EGGER CPL 0.2	PAINTED RAL 9003	MONO1 MAT	MONO2 MAT	VENEERED		
			SILKSTONE						UNI MAT PLUS	GROUP A	GROUP B
FZ1 144-169	FV1 136-161	FX1 164-189									
FZ2 169-194	FV2 161-186	FX2 189-214									
FZ3 194-219	FV3 186-211	FX3 214-239									
FZ4 219-244	FV4 211-236	FX4 239-264									
FZ5 244-269	FV5 236-261	FX5 264-289									
FZ6 269-294	FV6 261-286	FX6 289-314									
FZ7 294-319	FV7 286-311	FX7 314-339									
FZ8 319-344	FV8 311-336	FX8 339-364									
FZ9 344-369	FV9 336-361	FX9 364-389									

For double-leaf door extra charge

PANEL CONSTRUCTION (NRO 16 mm adjustment panel + 80 mm strip) - without NRO wall panels

B-30, C-30, RC3, SR37, EI30 SYSTEM POL-SKONE, EI30 PLUS	CERBER PLUS, CERBER PLUS RC2	EI60 PLUS	LAMISTONE CPL	PAINTED RAL 9003	VENEERED		
			SILKSTONE		GROUP A	GROUP B	GROUP C, D, SILKWOOD, REALWOOD
FZ1 144-169	FV1 136-161	FX1 164-189					
FZ2 169-194	FV2 161-186	FX2 189-214					
FZ3 194-219	FV3 186-211	FX3 214-239					
FZ4 219-244	FV4 211-236	FX4 239-264					
FZ5 244-269	FV5 236-261	FX5 264-289					
FZ6 269-294	FV6 261-286	FX6 289-314					
FZ7 294-319	FV7 286-311	FX7 314-339					
FZ8 319-344	FV8 311-336	FX8 339-364					
FZ9 344-369	FV9 336-361	FX9 364-389					

For double-leaf door extra charge

FV - CERBER PLUS door construction, CERBER PLUS RC2

FZ - B-30, C-30, RC3, EI30 SYSTEM POL-SKONE, EI30 PLUS, SR37 dB door construction

FX - EI60 PLUS door construction

CONSTRUCTION PRICE = PANEL CONSTRUCTION PRICE + WALL PANEL PRICE [m²] (VERTICAL + TOP PANELS) - p. 271

Smethod of joining trims: 45° (standard) or 90° (optional)

METAL TOP AND SIDE LIGHTS

Individual calculation after consultation with the Sales Department

1 linear meter of top and side lights on FD18 fixed door frame profile

The following glass types can be used for top and side lights (price per m²):

safe glass white matt 33.1, thickness 6.4 mm

safe transparent glass 33.1, thickness 6.4 mm

tempered white matt glass, thickness 6 mm

tempered transparent glass, thickness 6 mm

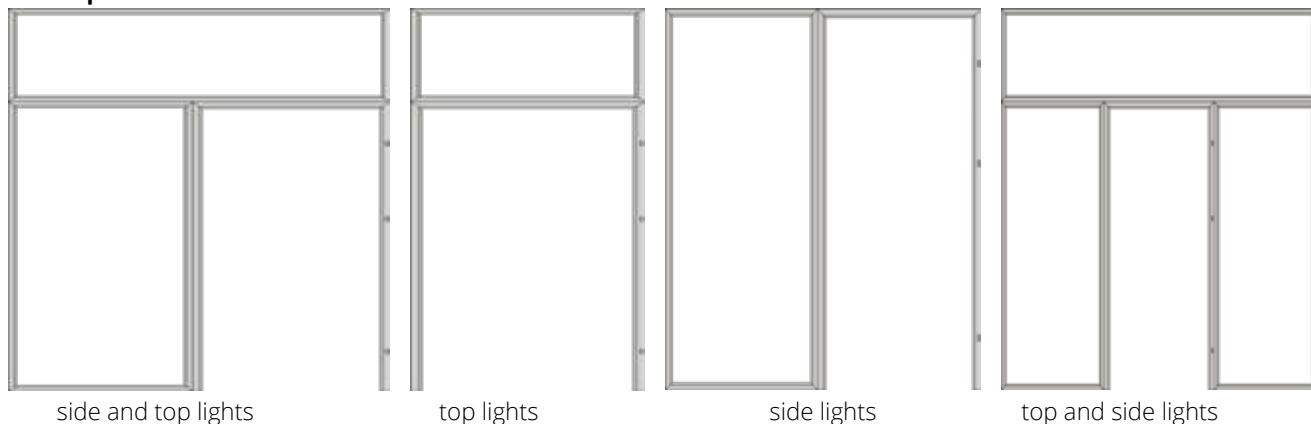

CALCULATION METHOD FOR TOP AND SIDE LIGHTS:
 price for 1 linear meter x 2 (A+B)
 + (extra charge for color) + price for 1 m² of glass x AxB

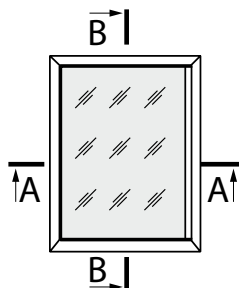

FD18 fixed metal DOOR FRAME

dedicated for metal top and side lights

The door frame is made of the highest quality steel sheet with a thickness of 1.5 mm

single-leaf	
"60" - "90"	"100" - "110"
double-leaf door	
"60" - "90"	"100" - "110"

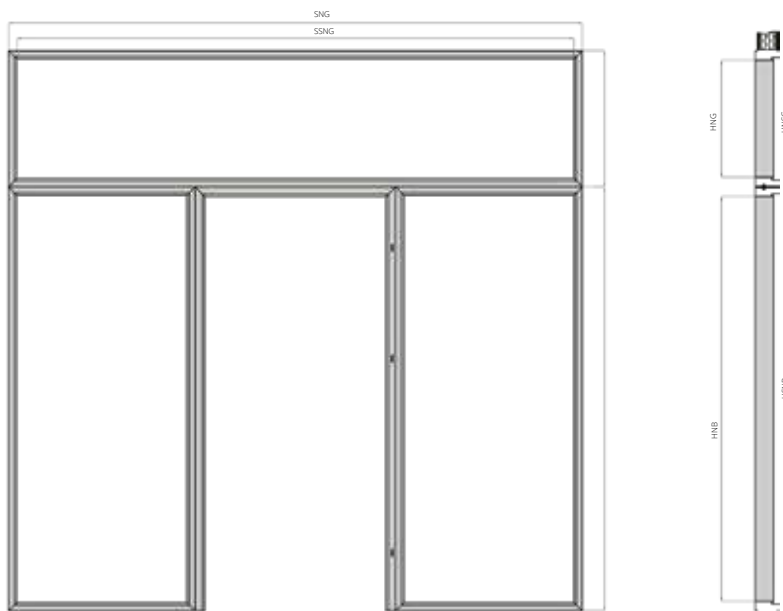

COLOR RANGE

Door frame painted with powder coating. Standard colors: white (RAL 9003), black (RAL 9005), white (RAL 9016), grey (RAL 7047), brown (RAL 8014), graphite (RAL 7024). Other colors according to RAL palettes available for extra charge - see extra charge table (p. 311)



DEDICATED FOR
 FD18 fixed metal door frame

COLOR RANGE

Top and side lights painted with powder coating. Standard color: white (RAL 9003), white (RAL 9016), grey (RAL 7047), brown (RAL 8014), graphite (RAL 7024), beige (NCS S 2005 Y50R). Other colors according to RAL palettes available for extra charge - according to the extra charge table (p. 311).

GLAZING

The top and side light can be filled with 6 mm tempered glass, 33.1 safety glass, or an HDF panel with a thickness of 6 mm.

DIMENSIONS

	min [mm]	max [mm]
SSNG	600	2442
SSNB	300	1000
HNG	300	1000
HSNB	1600	2400
The height of the entire set must not exceed 3300 mm		

SNB - width of the side top and side light
 SSNB - clear width of the side top and side light
 SSG - width of the upper top and side light
 SSNG - clear width of the upper top and side light
 HNB - height of the side top and side light
 HNG - height of the upper top and side light
 HSNB - clear height of the side top and side light
 HSNG - clear height of the upper top and side light

CONNECTION OF TOP AND SIDE LIGHT WITH DOOR FRAME

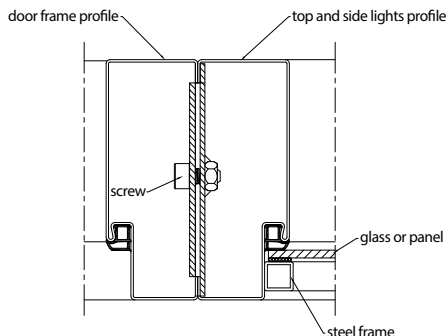



TOP AND SIDE LIGHTS FOR DIN/DIN DUO DOOR FRAME

REBATED SYSTEM



TOP AND SIDE LIGHTS on DIN door frame profile

(price per 1 linear meter of top and side light calculated by the external perimeter of the top and side light)

ZP1A	75-85
ZP1B	85-95
ZP2	95-120
ZP3	120-140
ZP4	140-160
ZP5	160-180
ZP6	180-200
ZP7	200-220
ZP8	220-240
ZP9	240-260
ZP10	260-280
ZP11	280-300

PAINTED 9003*	MONO1 MAT	ECO TOP	LAMISTONE CPL	laminated CPL 0.2	VENEERED		
			UNI MAT PLUS		GROUP A	GROUP B	GROUP C, D REALWOOD
			SILKSTONE				

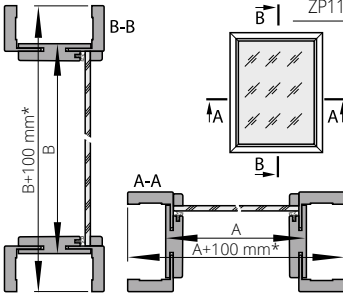

price of top and side light = price per 1 linear meter x 2(A+B) + price per 1 m² of glass x A x B

optionally, use of 80 mm trims

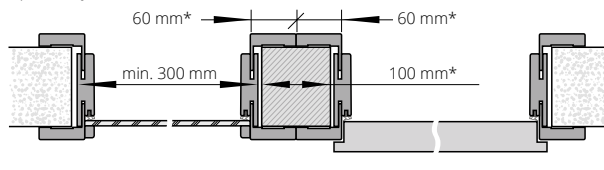

The maximum dimension of top and side lights and additional lights is:

- top and side lights AxB = 2190x700 mm
- additional lights AxB = 1000x2043 mm

*In case of using 60 mm trims - 60 mm

NON-REBATED SYSTEM



TOP AND SIDE LIGHTS on DIN DUO door frame profile

(price per 1 linear meter of top and side light calculated by the external perimeter of the top and side light)

ZD1	75-80
ZD2	80-85
ZD3	85-95
ZD4	95-120
ZD5	120-140
ZD6	140-160
ZD7	160-180
ZD8	180-200
ZD9	200-220
ZD10	220-240
ZD11	240-260
ZD12	260-280
ZD13	280-300

PAINTED 9003*	MONO1 MAT	ECO TOP	LAMISTONE CPL	laminated CPL 0.2	VENEERED		
			UNI MAT PLUS		GROUP A	GROUP B	GROUP C, D REALWOOD
			SILKSTONE				

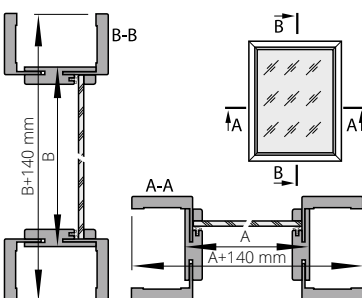

price of top and side light = price per 1 linear meter x 2(A+B) + price per 1 m² of glass x A x B

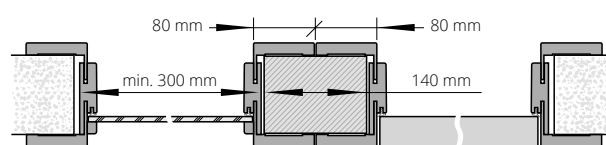

The maximum dimension of top and side lights and additional lights is:

- top and side lights SxH = 2207x700 mm
- additional lights SxH = 1000x2133 mm

THE FOLLOWING GLASS TYPES SHOULD BE USED FOR THE TOP AND SIDE LIGHT:

- safety glass white matt 33.1, thickness 6.4 mm
- safety glass transparent 33.1, thickness 6.4 mm
- tempered glass white matt, thickness 6 mm
- tempered transparent glass, thickness 6 mm

It is not possible to make trims for top and side lights DIN/DIN DUO at an angle of 90°.

Suggested method of connecting top and side lights on the DIN/DIN DUO door frame profile using mounting blocks



TOP AND SIDE LIGHTS FOR FIXED DOOR FRAME

TOP AND SIDE LIGHTS on the POL-SKONE fixed door frame profile (rebated system), **fixed DUO** (non-rebated system) (price per 1 linear meter of top and side light calculated by the external perimeter of the top and side light)

PAINTED 9003*	UNI MAT PLUS	laminated CPL 0.2	VENEERED		
	LAMISTONE CPL		GROUP A	GROUP B	GROUP C, D REALWOOD
SILKSTONE					

fixed 92 mm

price of top and side light = price per 1 linear meter x 2(A+B) + price per 1 m² of glass x A x B

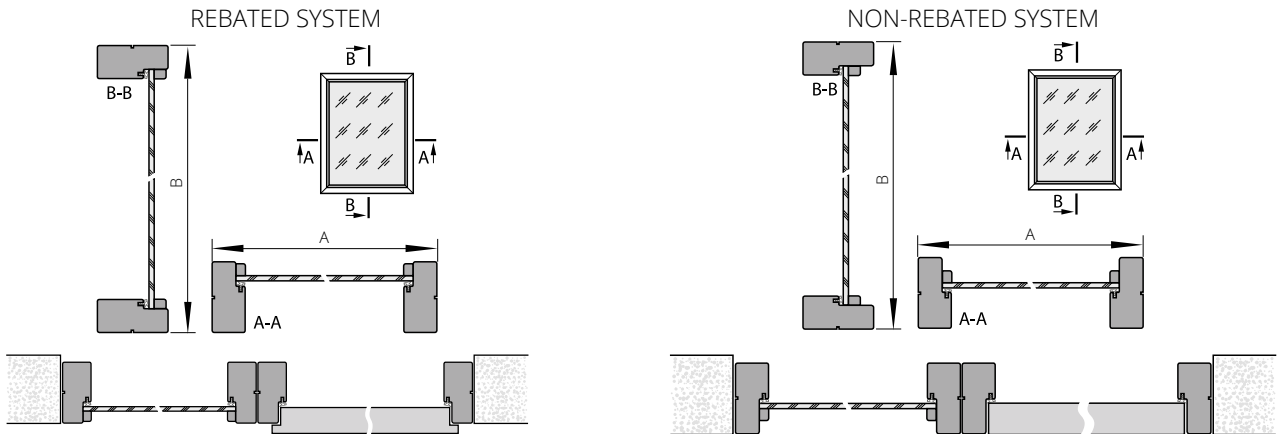

Suggested method of connecting top and side lights on the fixed/fixed DUO door frame profile

FIRE-RESISTANT TOP AND SIDE LIGHTS



SIDE AND TOP LIGHTS

price of top and side light = price per 1 linear meter x 2(A+B) + price per 1 m² of glass x A x B

surface

- LAMINATED
- UNI MAT PLUS
- LAMISTONE
- SILKSTONE
- PAINTED 9003
- MONO1 MAT
- MONO2 MAT
- MONO3 MAT
- VENEERED A
- VENEERED B
- VENEERED C, D
- SILKWOOD / REALWOOD

standard: transparent fire-resistant glass (m²)

(price per 1 linear meter)

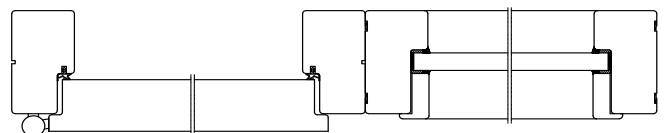

Side and top lights on the fixed door frame profile

- fire resistance EI30
- transparent fire-resistant glass
- maximum dimension of side lights 944 mm x 2175 mm
- maximum dimension of top lights 2152 mm x 425 mm
- minimum dimension of one side of the top and side light 300 mm

Top and side lights are sold according to the National Technical Assessment ITB-KOT-2020/1370 edition 1 and only as a set with FR EI30 fire doors of the POL-SKONE system. For individual approval, it is possible to use EI30 top and side lights with EI30 PLUS doors.

EQUIPMENT OF INTERIOR DOORS

	VENTILATION UNDERCUT	VENTILATION GAP	VENTILATION GRILLE (PLASTIC, STAINLESS STEEL)	PANEL WITH VENTILATION SURFACE	ABS PROTECTION	HEAT RECOVERY VENTILATION	ELECTRIC STRIKE	CONCEALED DOOR CLOSER (ONLY NON-REBATED SYSTEM)	SURFACE DOOR CLOSER	DROP SEAL (ONLY REBATED SYSTEM, NON-REBATED SYSTEM, HARMONY)
ADORE - p. 96	○	-	-	-	○	○	○	○	○	○
ARCO - p. 58	○	-	-	-	-	○ ⁶⁾	-	-	-	○
CAMBIO - p. 122	○	○	○	○	○	○	○	○	○	○
CREATO - p. 92	○	-	-	-	○	-	○	-	-	-
DECO - p. 86	○	○	○	○	○	○	○	○	○	○
DECO EGGER - p. 88	○	○	○	○	○	○	○	○	○	○
DECO LUX - p. 152	○	○	○	○	○	○	○	○	○	○
EGRO - p. 54	○	-	-	-	-	○ ⁶⁾	-	-	-	○
EMPORE - p. 98	○	○	-	-	-	-	-	-	-	-
ESPINA - p. 154	○	-	-	-	○	○ ⁵⁾	○	○ ⁵⁾	○ ⁵⁾	○ ⁵⁾
ESTATO - p. 126	○	-	-	-	○ ⁵⁾	○ ⁵⁾	-	○ ⁵⁾	○ ⁵⁾	○ ⁵⁾
ESTATO LUX - p. 160	○	-	-	-	-	-	-	○ ⁵⁾	○ ⁵⁾	○ ⁵⁾
ESTO - p. 56	○	-	-	-	-	○ ⁶⁾	-	-	-	○
ETIUDA - p. 104	○	-	-	-	○	○ ⁵⁾	○	○ ⁵⁾	○ ⁵⁾	○ ⁵⁾
FIORD - p. 134	○	○	-	-	○	○	○	○	○	○
FORTIMO - p. 74	○	○	-	-	-	○ ⁶⁾	-	-	-	○
FORTIMO LUX - p. 144	○	○	-	-	-	○ ⁶⁾	-	-	-	○
FORTO - p. 64	○	-	-	-	-	○ ⁶⁾	-	-	-	○
GALIO - p. 22	-	-	-	-	-	-	-	-	-	-
GALIO PIVOT - p. 28	-	-	-	-	-	-	-	-	-	-
HAPTIC - p. 82	○	○	○	○	○	○	○	○	○	○
HARMONY INVEST - p. 16	○ ²⁾	○ ²⁾	-	○	-	○ ⁷⁾	○	○	-	●
HARMONY INVEST PRO - p. 18	○ ²⁾	○ ²⁾	-	○	-	○ ⁷⁾	-	○ ⁸⁾	-	●
HARMONY MIRROR - p. 14	-	-	-	-	-	○	-	-	-	-
HARMONY SYSTEM POL-SKONE - p. 12	○ ¹⁾	○ ¹⁾⁴⁾	-	○ ¹⁾⁴⁾	-	○ ⁵⁾	○	-	-	○
IMPULS - p. 84	○	○ ⁴⁾	○	○	○	○ ⁵⁾	○	○ ⁵⁾	○ ⁵⁾	○ ⁵⁾
INTERSOLID - p. 146	○	○	-	-	○	-	-	-	-	○
INTERSOLID II - p. 148	○	○	-	-	○	-	-	-	-	○
INVERNO - p. 90	○	○	-	-	○	○	○	○	○	○
KINGSTONE - p. 150	○	○	-	-	○	○	○	-	-	○
LAURA - p. 68	○	-	-	-	-	-	-	-	-	-
LUMEN - p. 164	○	-	-	-	-	-	○	-	-	-
LUMEN LOFT - p. 166	○	-	-	-	-	-	○	-	-	-
LUMO - p. 26	-	-	-	-	-	-	-	-	-	-
MAESTO - p. 100	○	-	-	-	○	○	○	-	-	○
MAGRO - p. 66	○	-	-	-	-	○ ⁶⁾	-	-	-	○
MODENA - p. 118	○	○	-	-	○	○	○	-	-	○
MODERN - p. 108	○	○	-	-	○	○	○	-	-	○
MODESTO - p. 112	○	○	-	-	○	○	○	-	-	○
MODO - p. 52	○	-	-	-	-	○ ⁶⁾	-	-	-	○
MONA - p. 78	○	-	-	-	-	○ ⁶⁾	-	-	-	○
PALAZZO - p. 114	○	-	-	-	○	○	○	-	-	○
PASSO - p. 80	○	-	-	-	-	-	-	-	-	-
PRINCESTONE - p. 120	○	○	-	-	○	○	○	-	-	○
RIFLO - p. 138	○	○	-	-	-	-	-	-	-	-
ROYALE - p. 136	○	○	-	-	-	-	-	-	-	-
SALEA - p. 102	○	-	-	-	○	○	○	○	○	○
SAMOS - p. 62	○	-	-	-	-	○ ⁶⁾	-	-	-	○
SEDO - p. 48	○	-	-	-	-	○ ⁶⁾	-	-	-	○
SEMPRE - p. 70, 72	○	○	-	-	-	○ ⁶⁾	-	-	-	○
SEMPRE LUX - p. 140, 142	○	○	-	-	-	○ ⁶⁾	-	-	-	○
SENTO - p. 130	○	○	-	-	○	○	○	○	○	○
FOLDING - p. 162	-	-	-	-	○	-	-	-	-	-
SLIM - p. 76	○	-	-	-	-	○ ⁶⁾	-	-	-	○
SONATA - p. 94	○ ³⁾	-	-	-	○	○	○	○	○	○
SONATA LUX - p. 158	○	-	-	-	○	○	○	○	○	○
STALIO - p. 34	-	-	-	-	-	-	-	-	-	-
SUBITO - p. 124	○	-	-	-	○	○	○	○	○	○
SUBLIME - p. 132	○	-	-	-	○	○	○	○	○	○
TEO - p. 156	○	-	-	-	-	-	-	-	-	-
TIARA - p. 128	○	○	-	-	○	○	○	○	○	○
UNITO - p. 60	○	-	-	-	-	○ ⁶⁾	-	-	-	○
VERI - p. 50	○	-	-	-	-	○ ⁶⁾	-	-	-	○
VERTIGO - p. 116	○	○	-	-	○	○	○	-	-	○
VILANO - p. 110	○	○	-	-	-	-	-	-	-	○
VISIO - p. 40	-	-	-	-	-	-	-	-	-	-
VISIO M - p. 44	-	-	-	-	-	-	-	-	-	-
VISIO LUX - p. 42	-	-	-	-	-	-	-	-	-	-
ZENN - p. 106	○	-	-	-	-	○ ⁵⁾	○	○ ⁵⁾	○ ⁵⁾	○ ⁵⁾

● STANDARD
○ OPTIONALLY

1) does not apply to door leaves adapted for a mirror
2) without declared acoustic insulation and air permeability
3) does not apply to versions VD9, VD10, VD11
4) does not apply to version V1SA

5) does not apply to versions V1SA, V2SA, V3SA
6) only with standard height
7) without declared acoustic insulation and air permeability
8) does not apply to doors opening inwards

ACCESSORIES

HINGES FOR INTERIOR DOORS

REBATED SYSTEM



screw-in pin hinge type B
silver galvanized, black
color or brushed nickel

screw-in pin hinge
type D, silver
galvanized or
brushed nickel

screw-in pin hinge
type C*
silver galvanized, black
color or brushed nickel

screw-in pin hinge
type K*
silver galvanized, black
color or brushed
nickel

pin hinge type
M for metal
door frame
silver galvanized

pin hinge type M
for metal door
frame black color

hinge with closing
function (fixed or
adjustable wooden
door frame,
one-sided) silver
galvanized

REBATED SYSTEM – three-part hinge type T*



silver for door
frame
SYSTEM DIN

black for door
frame
SYSTEM DIN

gold for door
frame
SYSTEM DIN

silver
for metal
door frame

black
for metal
door frame

NON-REBATED SYSTEM – concealed adjustable hinge TE*



silver

white

black

gold

standard silver color

included in the price
of the door frame

door frame system DIN: change of hinge color to black, gold

metal door frame: change of hinge color to black

additional hinge silver color

additional hinge black, gold color

standard chrome matt color

included in the
price of the door
frame

change of hinge color to white, black

change of hinge color to gold

additional hinge chrome matt color

additional hinge white, black color

additional hinge gold color

NON-REBATED SYSTEM - concealed adjustable hinge DUO*



satin nickel

white

black
(BLACK MATT
collection)

gold

NON-REBATED SYSTEM - adjustable concealed hinge HARMONY*



satin chrome

white

black (BLACK
MATT collection)

gold

standard color satin nickel

included in the
price of the door
frame

change of hinge color to black, white

change of hinge color to gold metallic

additional hinge in satin nickel color

additional hinge white, black color

additional hinge in gold metallic color

standard color satin chrome

included in the
price of the door
frame

change of hinge color to white, black

without extra
charge

change of hinge color to gold

*hinges included with the door frame. When ordering only the door leaf, it is also necessary to order the hinge.

HINGE COVERS (set of 2 pcs. for one hinge)



TYPE I colors: gold, chrome,
chrome-matt, black



TYPE II colors: gold, chrome,
chrome-matt, brown, white, black

Type I covers are used for type C and type K hinges. A set of covers for one hinge consists of two identical covers.

Type II covers are used for type B and type D hinges. A set of covers for one hinge consists of a short cover (upper part) and a long cover (lower part).

ACCESSORIES

HINGES FOR TECHNICAL DOORS

Type of door	Remarks	Number of hinges	Type of hinges
TYPE A / TYPE B	-	3	pin hinge ø13.5
TYPE A / TYPE B DUO	for widths from "60" to "70"	2	concealed hinge DUO
	for widths from "80"	3	
	for elongated doors	3	
HIGRO	-	2	TECTUS by Simonswerk
GAMMA	for widths from "60" to "110"	3	hinge ECO SCHULTE OBX
SR 37 dB	for widths from "60" to "90 plus"	3	pin hinge ø20
	for width "100"	4	
RC3, RC3 INVEST	-	4	pin hinge ø16
CERBER PLUS, CERBER PLUS RC2, SEGURO	-	3	pin hinge ø16
B-30	for widths from "60" to "90 plus"	3	pin hinge ø20
	for width "100"	3	
	for elongated doors	3	
C-30	for widths from "60" to "90 plus"	3	pin hinge ø20
	for width "100"	3	
	for elongated doors	3	
FR EI30 SR 32 dB	for widths from "60" to "90 plus"	3	pin hinge ø20
	for width "100"	4	
	for elongated doors	4	
FR EI30 SR 42 dB DM, AKUSTIK 42 dB, AKUSTIK SEKURO 42 dB	-	2	hinge ECO SCHULTE OBX
EI30 PLUS	for widths from "60" to "90 plus"	3	pin hinge ø20
	for widths "100", "110"	4	
	for elongated doors over 25mm	4	
EI30 PLUS non-rebated version	-	3	ECO SCHULTE/TECTUS by Simonswerk
EI60 PLUS	-	4	pin hinge ø20
EI60 PLUS non-rebated version	-	3	ECO SCHULTE/TECTUS by Simonswerk
FR EI30 SR 42	for widths from "60" to "100"	2	hinge ECO SCHULTE OBX
	for width "110"	3	hinge ECO SCHULTE OBX

CONCEALED HINGES [NON-REBATED SYSTEM] FOR FIRE DOORS WITH METAL DOOR FRAME

door	color	width "60"-90" x height 2000 mm	width "100" x height 2000 mm	width "110" x height 2000 mm
EI30 PLUS		3 TECTUS hinges by Simonswerk TE 340 3D FR	3 TECTUS hinges by Simonswerk TE 340 3D FR	3 TECTUS hinges by Simonswerk TE 540 3D FR
	silver	extra charge per piece	extra charge per piece	extra charge per piece
	black/white	extra charge per piece	extra charge per piece	extra charge per piece
EI60 PLUS		3 TECTUS hinges by Simonswerk TE 540 3D FR	3 TECTUS hinges by Simonswerk TE 540 3D FR	3 TECTUS hinges by Simonswerk TE 540 3D FR
	silver	extra charge per piece	extra charge per piece	extra charge per piece
	black/white	extra charge per piece	extra charge per piece	extra charge per piece

CONCEALED HINGES [NON-REBATED SYSTEM] FOR FIRE DOORS WITH WOODEN DOOR FRAME

door	color	width "60"-90" x height 2000 mm	width "100" x height 2000 mm	width "110" x height 2000 mm
EI30 PLUS		3 TECTUS hinges by Simonswerk TE 340 3D FR	3 TECTUS hinges by Simonswerk TE 340 3D FR	3 TECTUS hinges by Simonswerk TE 540 3D FR
	silver	extra charge per piece	extra charge per piece	extra charge per piece
	black/white	extra charge per piece	extra charge per piece	extra charge per piece
EI60 PLUS		3 TECTUS hinges by Simonswerk TE 540 3D FR	3 TECTUS hinges by Simonswerk TE 540 3D FR	3 TECTUS hinges by Simonswerk TE 540 3D FR
	silver	extra charge per piece	extra charge per piece	extra charge per piece
	black/white	extra charge per piece	extra charge per piece	extra charge per piece

STAINLESS STEEL HINGES [REBATED SYSTEM]

	Type of hinge
interior metal door frame	OTLAV three-part OT-CI335-150IM02
DIN rebated door frame	OTLAV three-part OT-CI335-150IM04
fire protection EI30 PLUS, EI60 PLUS with metal door frame	ECO SCHULTE OBX-3011-3D (pocket)
	ECO SCHULTE OBX-18-1531/120 (hinge)
	ECO SCHULTE OBX-3011-3D (pocket) ECO SCHULTE OBX-18-1531/120 (hinge) black RAL 9005 extra charge for preparing milling for hinge
fire protection EI30 PLUS, EI60 PLUS with wooden door frame emergency exit EI30 POL-SKONE system	ECO SCHULTE OBX-3101-3D (pocket)
	ECO SCHULTE OBX-3199 (cover)
	ECO SCHULTE OBX-18-1531/120 (hinge)
	ECO SCHULTE OBX-3101-3D (pocket) ECO SCHULTE OBX-3199 (cover) black RAL 9005 ECO SCHULTE OBX-18-1531/120 (hinge) black RAL 9005

COVERS FOR HINGES FOR EI60 PLUS, EI30 PLUS B-30, C-30, FR EI30 DOOR (WOODEN DOOR FRAME)

PVC cover fi 20 mm white, brown, black
PVC cover fi 20 mm chrome matt, matt nickel

COVERS FOR HINGES FOR RC3 DOOR, CERBER PLUS, CERBER PLUS RC2, SEGURO (WOODEN DOOR FRAME)

PVC cover fi 16 mm white, brown, black
PVC cover fi 16 mm chrome matt, matt nickel

ACCESSORIES

LOCKS FOR INTERIOR DOORS



rebated

non-rebated

change of color of DUO non-rebated lock to white,
black, polished gold
change of the color of the rebated lock to black



satin chrome

black

white

polished gold

non-rebated with latch (options)

New (optional) type of mortise latch lock WK, WB, WC for **DUO non-rebated** doors for DIN DUO door frame, DIN DUO AQUA, DIN DUO SOLID, Vertigo (does not apply to the Reves system)
Flat strike plate with slide, non-adjustable.

HOOK LOCK for sliding doors



option WK lock

chrome, chrome matt, gold, gold-matt, patina

black



option WC lock

chrome, chrome matt, gold, gold-matt, patina

black

HANDLES for sliding doors



U1
gold

U2
gold-matt

U3
chrome

U4
chrome
matt

U5
patina

U6
black

124 mm

gold, gold-matt, chrome, chrome
matt, patina, black

ENTERO handle



satin nickel

ENTERO II handle



stainless steel

ENTERO satin nickel for screws

ENTERO satin nickel for screw + WC hook lock

ENTERO II stainless steel + WC lock

ENTERO II stainless steel



189 mm

MAYA handle

satin nickel

satin nickel + hook lock
for insert

30x30 mm LOB insert

satin nickel + WC lock

satin nickel

HANDLES for folding doors (standard included in the price of the door leaf)

made of plastic



01
white

02
beige

03
brown

04
grey

handle

ACCESSORIES

DOOR CLOSERS

Type of door	force	Surface-mounted door closers	Concealed door closer
B-30, C-30, RC3, SR 37 dB	4	GEZE TS 2000 NV, GEZE TS 3000, GROOM 200, DORMA TS 83	GEZE BOXER 2-4, ECO SCHULTE ITS 420 2-4, DORMA ITS 96 2-4
FR EI30	4	GEZE TS 2000 NV, GEZE TS 3000, GEZE TS 4000, GROOM 200, DORMA TS 83, DORMA TS 93	GEZE BOXER 2-4, ECO SCHULTE ITS 420 2-4, DORMA ITS 96 2-4
FR EI30 SR 42 dB, ACOUSTIC 42 dB	4	GEZE TS 2000 NV, GEZE TS 3000, GEZE TS 4000, GROOM 200, DORMA TS 83, DORMA TS 93	GEZE BOXER 2-4, DORMA ITS 96 2-4
EI30 PLUS full height up to 2200 mm	4*	GEZE TS 2000 NV*, GEZE TS 3000, GEZE TS 4000*, GROOM 200*, DORMA TS 83*	GEZE BOXER 2-4, ECO SCHULTE ITS 420 2-4, DORMA ITS 96 2-4
EI30 PLUS full height from 2201 mm to 2500 mm	5	GEZE TS 2000 NV, GROOM 200, DORMA TS 83, DORMA TS 93	-
EI30 PLUS glazed height up to 2200 mm	5	GEZE TS 2000 NV, GROOM 200, DORMA TS 83, DORMA TS 93	-
EI30 PLUS glazed height from 2201 mm to 2500 mm	6	GEZE TS 4000, GEZE TS 5000, DORMA TS 83, DORMA TS 93	-
EI60 PLUS solid height up to 2200 mm	5	GEZE TS 2000 NV, GROOM 200, DORMA TS 83, DORMA TS 93	GEZE BOXER 2-4 *** ECO SCHULTE ITS 420 2-4 **** DORMA ITS 96 3-6
EI60 PLUS solid height from 2201 mm to 2500 mm	6	GEZE TS 4000, GEZE TS 5000, DORMA TS 83, DORMA TS 93	DORMA ITS 96 3-6
EI60 PLUS glazed height up to 2400 mm	6**	GEZE TS 4000, GEZE TS 5000, DORMA TS 83**, DORMA TS 93**	DORMA ITS 96 3-6
EI60 PLUS glazed height from 2401 mm to 2500 mm	7	DORMA TS 83, DORMA TS 93	-
sound-insulating TYPE A, TYPE B	4*	GEZE TS 2000 NV*, GEZE TS 3000, GEZE TS 4000*, GROOM 200, DORMA TS 83	-
sound-insulating TYPE A DUO, TYPE B DUO	4*	GEZE TS 2000 NV, GEZE TS 3000, GEZE TS 4000, GROOM 200, DORMA TS 83	GEZE BOXER 2-4 **** ECO SCHULTE ITS 420 2-4, DORMA ITS 96 2-4
interior	4*	GEZE TS 2000 NV*, GEZE TS 3000, GEZE TS 4000*, GROOM 200, DORMA TS 83	GEZE BOXER 2-4 with rail*****, ASSA ABLOY DC840 with G892 rail

Arm closer: GEZE TS 2000 NV, GROOM 200, DORMA TS 83, GEZE TS 4000 Rail closer: GEZE TS 3000, DORMA TS 93, GEZE TS 5000

* for door leaf of width "110" mm, closer size 5

** for door leaf of width "110" mm, closer size 7

*** only for doors with dimensions 1012x2075 mm

**** only with fixed door frame

***** door leaf thickness 46 mm, applies to rebated doors

CONCEALED DOOR CLOSERS

ITS 96 (2-4) DORMA WITH RAIL (silver color) (easy open function, opening limiter)

ITS 420 2-4 ECO SCHULTE WITH RAIL

ITS 96 (3-6) DORMA WITH RAIL (silver color) (easy open function, opening limiter)

GEZE BOXER 2-4 (silver color)

GEZE BOXER 3-6 (silver color)

GEZE BOXER 3-6 (black color RAL 9005)

GEZE BOXER 2-4 with electromechanical opening lock

GEZE BOXER 2-4 (black color RAL 9005) body in silver color, rail in RAL 9005 color

ITS 96 (2-4) DORMA WITH RAIL (black color RAL 9005) (easy open function, opening limiter)

ITS 96 (3-6) DORMA WITH RAIL (black color RAL 9005) (easy open function, opening limiter)

mechanical opening lock GEZE BOXER

milling for door closer

opening angle limiter for door closer GEZE BOXER

SURFACE-MOUNTED DOOR CLOSERS SURFACE-MOUNTED GEZE, DORMA/GROOM

GEZE TS 2000 NV (2-4) door closer with arm (silver, white, brown color)

GEZE TS 3000 (1-4) door closer with rail and mounting plate

GEZE TS 4000 (1-6) door closer with arm (silver color)

GEZE TS 5000 door closer (2-6) with rail and mounting plate (silver color)

RF G-N opening angle limiter for TS 93B door closer

GROOM GR 200 door closer (2-5)

DORMA TS 83 door closer (3-6) with arm

DORMA TS Profil door closer (silver, white, black, brown color)

DORMA TS Profil door closer with mounting plate (silver, white, black, brown color)

GEZE TS 2000 NV (2-4) door closer with arm (black color RAL 9005)

GEZE TS 3000 door closer with rail and mounting plate (black color RAL 9005)

GEZE TS 4000 door closer with arm (black color RAL 9005)

GEZE TS 5000 door closer (2-6) with rail and mounting plate (black color RAL 9005)

DORMA TS 91 door closer (4) with rail (easy open assistance function)

DORMA TS 91 door closer (4) with rail (black color RAL 9005)

DORMA TS 93B door closer (2-5) with rail (easy open assistance function)

ASSA 2396 semi-automatic surface bolts for doors with door closer and closing sequence control (for 1 piece of double-leaf door)

In the case of double-leaf fire doors, it is required to use closing sequence control due to the requirement for permanent closure of fire doors. In the event of a fire. Closing sequence control can be used in double-leaf fire doors with wooden or metal door frames, as well as in double-leaf interior doors with adjustable DIN system door frame or metal door frame. The minimum width of double-leaf door for which closing sequence control can be applied is "90+40". In the case of doors with an inactive door leaf of width "30", it is not possible to install a door closer. In the case of doors equipped with manually operated surface bolts, it is necessary to obtain the opinion of a fire safety expert, who will analyze the situation and approve such a solution in the given building.

Set of door closers with closing sequence control (the price includes 2 pcs. of TS93B surface-mounted door closer and GSR V rail). Fire doors must be equipped with ASSA 2396 automatic surface bolts or a panic bar with three-point locking. Interior doors must be equipped with a panic bar with three-point locking. Additionally, if the doors are to remain permanently open, they should be equipped with electromagnetic holders.

GTR 048 by DORMAKABA

GTR 048 by DORMAKABA allowing the installation of a floor holder, an optional bracket should be additionally ordered. Set holder + bracket

spring door closer

	for wooden door frame	for metal door frame
silver	black	silver
black	silver	black

ACCESSORIES

PANIC BAR FOR SINGLE-LEAF DOOR (EMERGENCY EXIT, FIRE, AND INTERIOR DOORS) WITH SINGLE-POINT LOCKING

PHA 2102 panic bar for fire doors
PHA 2104 panic bar rod for fire doors (for door leaf up to 1000 mm wide)
PHA 2105 panic bar rod for fire doors (for door leaf up to 1300 mm wide)
PHT 05 F panic handle with spindle for fire doors
asymmetric cylinder class A silver 9/31 standard
strike for bar, 1 pc.

PANIC BAR FOR SINGLE-LEAF DOOR (FIRE DOORS) WITH THREE-POINT LOCKING

PHA 2102 panic bar for fire doors
PHA 2104 panic bar rod for fire doors (for door leaf up to 1000 mm wide)
PHA 2105 panic bar rod for fire doors (for door leaf up to 1300 mm wide)
PHT 05 F panic handle with spindle for fire doors
PHX 04 vertical rods with cover (for door leaf with height 2270 mm)
PHX 05 vertical rods with cover (for door leaf with height 3400 mm)
PHX 03 vertical bolts with strikes
asymmetric cylinder class A silver 9/31 standard
strike for bar, 2 pcs.

PANIC BAR FOR DOUBLE-LEAF DOOR (EMERGENCY EXIT, FIRE, AND INTERIOR DOORS) WITH THREE-POINT LOCKING

PHA 2102 panic bar for fire doors - 2 pcs.
PHA 2104 panic bar rod for fire doors (for door leaf up to 1000 mm wide) - 2 pcs.
PHA 2105 panic bar rod for fire doors (for door leaf up to 1300 mm wide) - 2 pcs.
PHA 3905 panic handle with spindle for fire doors
PHX 04 vertical rods with cover (for door leaf with height 2270 mm)
PHX 05 vertical rods with cover (for door leaf with height 3400 mm)
PHX 03 vertical bolts with strikes
asymmetric cylinder class A silver 9/31 standard
strike for bar, 1 pc.

FITTINGS FOR SINGLE-LEAF EMERGENCY EXIT DOOR WITH MORTISE LOCK (FOR FIRE DOORS EI30, EI60 WITH METAL DOOR FRAME) (SET: BAR + ROD + SPINDLE + HANDLE OR KNOB)

PHA 2500 bar panic function B*
PHA 2500 bar panic function D*
PHA 2500 bar panic function E*
PHA 2104 bar (for door leaf of width up to 1000 mm)
PHA 2105 bar (for door leaf of width up to 1300 mm)
*lock with rounded plate 20x235 mm, backset 65 mm, right or left

Fittings available in Silver finish and stainless steel

Split spindle PR 120 FS-53 (for EI30 door PLUS)
Split spindle PR 120 FS-60 (for EI60 PLUS door)
Handle 8100 with long plate 7051 (function B, D) - aluminium finish
Handle 8100 with long plate 7051 (function B, D) - stainless steel finish
Spindle PR 115 FS-75 (for EI30 PLUS door)
Spindle PR 115 FS-75 (for EI60 PLUS door)
Knob 8020 with long plate 7051 (function E) - stainless steel color
Knob 8020 with long plate 7051 (function E) - aluminium color

FIRE-RESISTANT HANDLES FOR EI30 SR 32, EI30 PLUS, SR 37 DOORS

Handle 903.92.276 (square spindle 8 mm, length 100 mm, screws length 60 mm) + WB escutcheon
Handle 903.92.076 (square spindle 8 mm, length 100 mm, screws length 60 mm) + WB escutcheon
Handle 903.92.154 (square spindle 8 mm, length 100 mm, screws length 60 mm) + WB escutcheon



903.92.276



903.92.076



903.92.154

FIRE-RESISTANT HANDLES FOR EI30 SR 42, EI60 PLUS DOORS

Handle 903.92.276 (square spindle 8 mm length 100 mm, screws length 70 mm) + WB escutcheon
Handle 903.92.076 (square spindle 8 mm length 100 mm, screws length 70 mm) + WB escutcheon
Handle 903.92.154 (square spindle 8 mm length 100 mm, screws length 70 mm) + WB escutcheon

ACCESSORIES

PANIC MORTISE LOCKS FOR INTERIOR DOORS (SET INCLUDES LOCK + SPINDLE + HANDLE)

GBS 92 with panic function type B, backset 65 mm, faceplate 20x235 mm

GBS 92 with panic function type D, backset 65 mm, faceplate 20x235 mm

GBS 92 with panic function type E, backset 65 mm, faceplate 20x235 mm

split spindle 9 mm (panic function type D and B)

handle – handle (panic function type D and B)

handle – knob (spindle 9 mm, panic function type E)

MAGNETIC LOCK

EMG 600 AL magnetic lock

reinforcement for magnetic lock for DIN door frame

reinforcement for magnetic lock for steel door frame

mounting element EMG-B 600 L (L bracket)

mounting element EMG-B 600 LZ (L+Z bracket)

mounting element for fire-resistant doors EMG-B 600 AH

ELECTRIC STRIKE FOR DECO INVEST DOUBLE-LEAF DOOR

electric strike 118 fail-secure + strike plate + cable gland + cable + milling for electric strike

electric strike 138/NO/Profix2/1 fail-safe + strike plate + cable gland + cable + milling for electric strike

FAIL-SECURE ELECTRIC STRIKE IN DOUBLE-LEAF FIRE DOORS EI30 PLUS OF THE HALSPAN SYSTEM (SET: ELECTRIC STRIKE + STRIKE PLATE + CABLE + CABLE DUCT)

HARTTE SHD12U electric strike (12V AC/DC)

HARTTE SHD24U electric strike (24V AC/DC)

JiS 1710 electric strike 12-24 AC/DC

SHD series, other models of electric strikes available upon consultation with the Sales Department

FL 22 electric strike plate

Cable EFF-EFF 760-250-00

EA 281 cable duct

FAIL-SECURE ELECTRIC STRIKE IN SINGLE-LEAF FIRE DOORS EI30 PLUS OF THE HALSPAN SYSTEM (SET: ELECTRIC STRIKE + STRIKE PLATE)

HARTTE SHD12U electric strike (12V AC/DC)

HARTTE SHD24U electric strike (24V AC/DC)

JiS 1710 electric strike 12-24 AC/DC

SPEC-240 electric strike plate (rebated door)

SPEC-251 electric strike plate (non-rebated door)

SHD series, other models of electric strikes available upon consultation with the Sales Department

FAIL-SAFE ELECTRIC STRIKE IN SINGLE-LEAF FIRE DOORS EI30, EI30 PLUS, EI60 PLUS (SET: ELECTRIC STRIKE + STRIKE PLATE + ALR - WN LOCK)

HARTTE SHD12R electric strike (12V DC)

HARTTE SHD24R electric strike (24V DC)

ALR-WN lock (Bira)

SPEC-250 electric strike plate (rebated door)

SPEC-236 electric strike plate (non-rebated door)

PANIC MORTISE LOCKS (SET INCLUDES LOCK + SPINDLE + HANDLE) FOR TECHNICAL DOORS (FOR FIRE-RESISTANT DOORS EI30, EI30 PLUS, EI60 PLUS)

GBS 92 with panic function type B, backset 65, lock faceplate 24x235

GBS 92 with panic function type E, backset 65, lock faceplate 24x235

GBS 92 with panic function type D, backset 65, lock faceplate 24x235

split spindle 9 mm

double-sided handle for door with panic lock:

handle - handle on oval plate

handle - knob on oval plate

REED SWITCH

MC 250 flush-mounted reed switch

MC200-S19 mounting collar for reed switch (white color) (for metal door frames)

SPECIAL LOCKS

ABLOY EL560/EI 561 lock (lock + cover (cable gland) EA 281 + cable EA 218)

milling for lock

ELECTRIC STRIKES FOR METAL DOOR FRAME FOR RC3 DOORS

BIRA symmetrical electric strike 12V AC/DC standard

BIRA symmetrical electric strike 12V AC/DC with closure monitoring, standard

reinforcement of RC3 metal door frame for electric strike

FAIL-SECURE ELECTRIC STRIKE IN DOUBLE-LEAF FIRE DOORS EI30 AND EI60 PLUS OF THE HALSPAN SYSTEM (SET: ELECTRIC STRIKE + STRIKE PLATE + CABLE + CABLE DUCT)

HARTTE SHD12U electric strike (12V AC/DC)

HARTTE SHD24U electric strike (24V AC/DC)

FL 22 electric strike plate

SHD series, other models of electric strikes available upon consultation with the Sales Department

Cable EFF-EFF 760-250-00

EA 281 cable duct

FAIL-SECURE ELECTRIC STRIKE IN SINGLE-LEAF FIRE DOORS POL-SKONE EI30 AND EI60 PLUS OF THE HALSPAN SYSTEM (SET: ELECTRIC STRIKE + STRIKE PLATE)

HARTTE SHD12U electric strike (12V AC/DC)

HARTTE SHD24U electric strike (24V AC/DC)

SPEC-240 electric strike plate (rebated door)

SPEC-251 electric strike plate (non-rebated door)

SHD series, other models of electric strikes available upon consultation with the Sales Department

FAIL-SAFE ELECTRIC STRIKE IN DOUBLE-LEAF FIRE DOORS EI30, EI30 PLUS, EI60 PLUS (SET: ELECTRIC STRIKE + STRIKE PLATE + ALR - WN LOCK + CABLE + CABLE DUCT)

HARTTE SHD12R electric strike (12V DC)

HARTTE SHD24R electric strike (24V DC)

ALR-WN lock (Bira)

OKU-007 electric strike plate

Cable EFF-EFF 760-250-00

EA 281 cable duct

ACCESSORIES

HARMONY DOOR FRAME (RAW, FOR INDIVIDUAL FINISHING) ADAPTED FOR ELECTRIC STRIKE

DOOR FRAME WITH FAIL-SECURE ELECTRIC STRIKE
EFF-EFF 118.13 A71

"60"- "80" x 2040/2050 mm

"90"- "100" x 2040/2050 mm

"60"- "100" x 2140/2150 mm

"60"- "100" x 2240/2250 mm

"60"- "100" x 2340/2350 mm

"60"- "100" x 2440/2450 mm

DOOR FRAME WITH FAIL-SAFE ELECTRIC STRIKE
EFF-EFF 138.13 E91 PROFIX2

"60"- "80" x 2040/2050 mm

"90"- "100" x 2040/2050 mm

"60"- "100" x 2140/2150 mm

"60"- "100" x 2240/2250 mm

"60"- "100" x 2340/2350 mm

"60"- "100" x 2440/2450 mm

FIXED, ADJUSTABLE DOOR FRAME (SYS. REBATED)

fail-secure electric strike JIS 1710 12-24V AC/DC (including strike plate and milling for electric strike) *

fail-secure electric strike BIRA HARTTE XS narrow XS12U 12V AC/DC (including plate and milling for electric strike)*

Fail-secure electric strike with switch BIRA HARTTE XS12UW 12V AC/DC (including strike plate and milling for electric strike)*

fail-safe electric strike BIRA HARTTE XS narrow XS12R 12V DC (including strike plate and milling for electric strike)*

FIXED, ADJUSTABLE DOOR FRAME (SYS. NON-REBATED)

BIRA HARTTE XS narrow electric strike with latch (fail-safe) XS12R-C 12V DC (including SPEC-525 strike plate and milling for electric strike)*

BIRA HARTTE XS narrow electric strike with latch (fail-secure) XS12U-C 12V AC/DC (including SPEC-525 strike plate and milling for electric strike)*

BIRA HARTTE XS narrow electric strike with latch (fail-secure with switch) XS12UW-C 12V AC/DC (including SPEC-525 strike plate and milling for electric strike)*

METAL DOOR FRAME (SYS. REBATED)

fail-safe electric strike BIRA F12U (12V AC/DC) including strike plate and adaptation for electric strike

fail-secure electric strike BIRA F12R (12V DC) including strike plate and adaptation for electric strike

METAL DOOR FRAME (SYS. NON-REBATED)

BIRA electric strike with latch (reversible) F12R-C (12V DC) (including SPEC-727 strike plate and adaptation for electric strike)*

BIRA electric strike with latch (fail-secure) F12U-C (12V AC/DC) (including SPEC-727 strike plate and adaptation for electric strike)*

HARMONY INVEST DOOR FRAME

BIRA HARTTE XS NARROW electric strike with latch (fail-safe) XS12R-C 12V DC (including SPEC 525 strike plate and milling for electric strike)* (door opening outwards)

BIRA HARTTE XS NARROW electric strike with latch release (fail-secure) XS12U-C 12V AC/DC (including SPEC 525 strike plate and milling for electric strike)* (door opening outwards)

BIRA HARTTE XS NARROW electric strike with latch release (fail-secure with switch) XS12UW-C 12V AC/DC (including SPEC 525 strike plate and milling for electric strike)* (door opening outwards)

* in the case of using an electric strike, it is necessary to change to ECO Schulte GBS 12 lock

ACCESSORIES

OAK THRESHOLDS FOR CERBER PLUS, CERBER RC2, SEGURO, B-30, C-30, RC3 DOORS



black threshold, ALU strip in black color



brown threshold, ALU strip in black color



gray threshold, ALU strip in silver color



drop seal

purchased separately
(to be cut to size by the customer)

installed in the door

Possible to use only with a door leaf of minimum thickness 40 mm (bottom stile and rail).



drop seal for modular doors

installed in the door

ABS EDGE

INVESTMENT SOLUTION



titano



white



Polish oak



anthracite



black

available in rebated and non-rebated system



ABS1

white



ABS2

grey



ABS3

beige



ABS4

brown



ABS5

black



ABS6

blue



ABS7

graphite

available in non-rebated system

Protection of the bottom edge against moisture with ABS edge

PORTHOLES

BMD

view from the hinge side



reverse



size	S ₀	color
porthole 1 (Ø 240 mm, thickness 18, 40 mm)	135 mm	
porthole 2 (Ø 320 mm, thickness 18, 40 mm)	215 mm	stainless steel (matt)
porthole 3 (Ø 350 mm, thickness 18, 40 mm)	235 mm	glass - lakomat
porthole 4 (Ø 400 mm, thickness 18, 40 mm)	280 mm	

BMJ

view from the hinge side



reverse



size	S ₀	color
porthole 2 (Ø 300 mm, thickness 35-45 mm)	225 mm	
porthole 3 (Ø 350 mm, thickness 35-45 mm)	265 mm	stainless steel (matt)
porthole 4 (Ø 400 mm, thickness 35-45 mm)	295 mm	glass - lakomat

BMN

view from the hinge side



reverse



size	S ₀	color
porthole 2 (Ø 300 mm, thickness 35-45 mm)	225 mm	
porthole 3 (Ø 350 mm, thickness 35-45 mm)	265 mm	stainless steel (matt)
porthole 4 (Ø 400 mm, thickness 35-45 mm)	295 mm	glass - lakomat

DOOR MODELS	PORTHOLES ONLY IN FULL VERSIONS	NOTES
DECO, HAPTIC	BMD, BMJ, BMN	
DECO LUX	BMD, BMJ, BMN	
ETIUDA version B0	BMD, BMJ, BMN	
IMPULS	(BMD, BMJ, BMN) ¹	only in version 01
INTERSOLID II ²	BMD ¹	1) porthole only in width "70", "80", "90" 2) does not apply to versions 10, 11
INTERSOLID	BMD ¹	1) porthole only in width "70", "80", "90"
MODERN, MODERN DUO	BMD ¹	1) porthole only in width "70", "80", "90"
CAMBIO, CAMBIO DUO	BMD, BMJ, BMN	
INTER-AMBER	BMD, BMJ, BMN	

Matt, safe laminated glass - as standard (does not apply to BMD)
Transparent glass - extra charge (does not apply to BMJ)
necessity to order a chipboard when using a porthole

S₀ - dimension on the inner side of the porthole



PANORAMIC VIEWER

stainless steel

brass

black matt

anthracite

Viewers:

- interior door leaves, Cerber Plus: viewer Ø15 LOB with a range of 35-55 mm
- technical door leaves: viewer Ø20 Panorama 200 with a range of 45-70 mm

FIRE-RESISTANT PORTHOLE FOR DOOR LEAFS EI30 PLUS, EI60 PLUS (CLEAR GLASS)

fire-resistant porthole for door leaf EI30 PLUS

(Ø 320 mm)

fire-resistant porthole for door leaf EI60 PLUS

(Ø 320 mm)

VENTILATION OPTIONS



Ventilation undercut stained in a color similar to the door leaf, protected with a moisture-resistant impregnant.

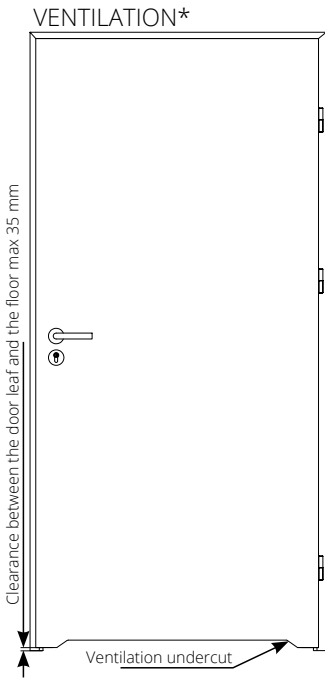

PANEL CONSTRUCTION

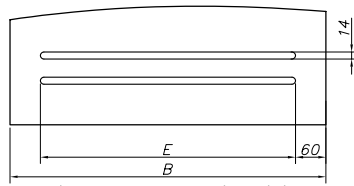

ventilation gap in non-rebated door leaves

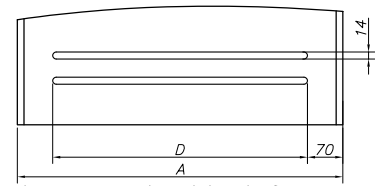

ventilation gap in rebated door leaves - extra charge

	A	B	C	D	E
"80"	844	825	685	704	705
"90"	944	925	785	804	805

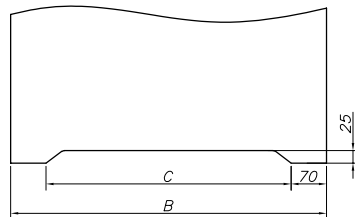

ventilation undercut in non-rebated door leaves
- extra charge for veneered surfaces
- extra charge for synthetic/painted surfaces

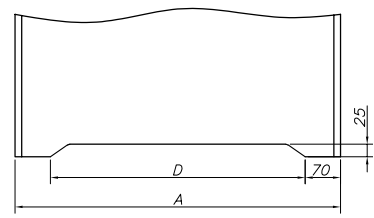

ventilation undercut in rebated door leaves
- extra charge for veneered surfaces
- extra charge for synthetic/painted surfaces

ARCO, SEDO, MODO, VERI, EGRO

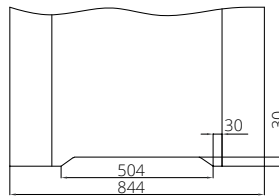

door leaf "80" with ventilation undercut

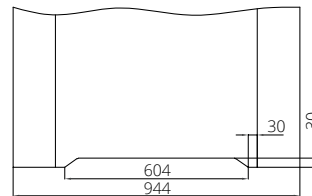

door leaf "90" with ventilation undercut

VERTIGO, VILANO

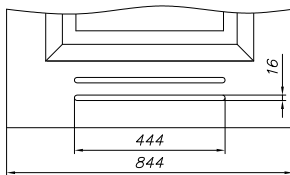

door leaf "80" with ventilation gap

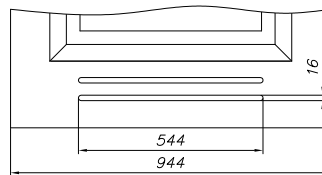

door leaf "90" with ventilation gap

LUMEN/LUMEN LOFT

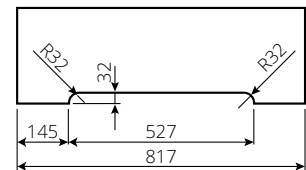

SEMPRE/SEMPRE DUO

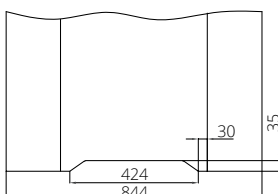

door leaf "80" with ventilation undercut

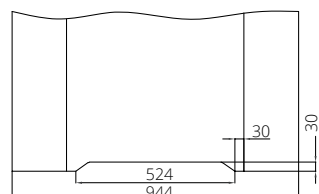

door leaf "90" with ventilation undercut

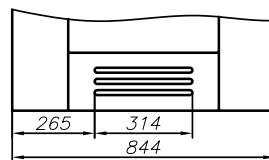

door leaf "80" with ventilation gap

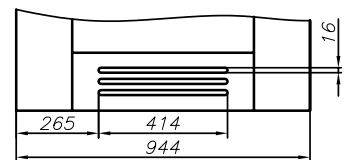

door leaf "90" with ventilation gap

ventilation gap in door leaves from the SEMPRE, INTERSOLID collection - extra charge

The standard clearance between the door leaf and the floor is 10 mm

* In accordance with the Regulation of the Minister of Infrastructure of 12 April 2002 on the technical conditions to be met by buildings and their location. (Journal of Laws 75 of 2002, item 690 as amended, Journal of Laws No. 33 of 2003, item 270, Journal of Laws No. 109 of 2004, item 1156) Chapter 6, §. 79. "Doors to bathrooms, washrooms, and separate toilets should open outwards, have, subject to § 75 sec. 2, at least 0.8 m width and 2 m height in the clear opening of the door frame, and in the lower part - openings with a total cross-section of not less than 0.022 m² for air supply."

** the clearance should be increased by the given value by shortening the door leaf from the bottom if shortening is possible.

Door leaves that cannot be shortened: Etiuda

Sliding door leaves, due to their construction (offset from the wall/tunnel by about 20 mm), meet the requirements of the regulation without the need for ventilation undercut or ventilation sleeves.

IMPULS 13, ESTADO, ESTADO LUX, CREATO, ETIUDA "80" (applies to versions A01, A02)

rebated version

ventilation undercut
version A01
- extra charge

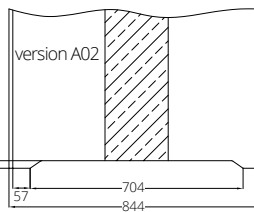
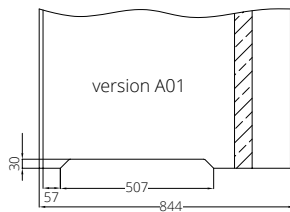

ventilation undercut
version A02
- extra charge

non-rebated version

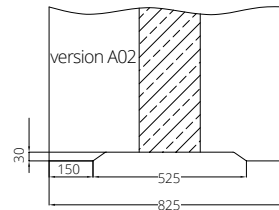
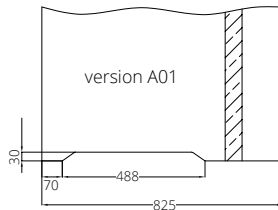

DOOR WITH VENTILATION UNDERCUT

Door width	Total cross-section of ventilation openings with a clearance of 10 mm maintained [m ²]	
REBATED	"60"	0,019
	"70"	0,022
	"80"	0,026
	"90"	0,029
	"100"	0,033
DUO (NON-REBATED) REVES	"60"	0,016
	"70"	0,020
	"80"	0,024
	"90"	0,028
	"100"	0,032
LUMEN	"60"	0,015
	"70"	0,019
	"80"	0,023
ARCO	"60"	0,017
	"70"	0,021
	"80"	0,026
	"90"	0,030
SEMPRE	"60"	0,014
	"70"	0,018
	"80"	0,023
	"90"	0,027
FORTIMO	"60"	0,016
	"70"	0,020
	"80"	0,024
	"90"	0,028

As standard, the clearance between the door leaf and the floor is 10 mm

Door leaves that cannot be shortened: Etiuda

Sliding door leaves, due to their construction (offset from the wall/wall system by approximately 20 mm), meet the requirements of the regulation without the need for ventilation undercut or ventilation sleeves. Ventilation grilles and stainless steel panels with a ventilated surface meet the requirements of the regulation.

PANEL WITH VENTILATED SURFACE



- _____ extra charge "70"
- _____ extra charge "80"
- _____ extra charge "90", "90 plus"
- _____ extra charge "100"
- _____ extra charge "110"

STAINLESS STEEL VENTILATION GRILLE



- _____ H17 snap-in mounting
- _____ acid-resistant snap-in mounting

Optionally, it is possible to order grilles and panels made of stainless steel. The surface area of openings for air supply is above 0.022 m².

FIRE GRILLE FOR DOOR EI30 PLUS, EI60 PLUS

GRILLE DIMENSION [MM]

500 x 150

300 x 150

ADDITIONAL EQUIPMENT

STAINLESS STEEL SHEET THICKNESS 0.6 MM **FOR FIRE DOORS EI30, EI30 PLUS, EI60 PLUS** (1 SET FOR BOTH SIDES)

width "60" width "70" width "80" width "90" width "100" width "110" width "120"

variant A: polished or brushed sheet

STAINLESS STEEL SHEET THICKNESS 0.6 MM **FOR INTERIOR DOORS** (1 SET)

variant A: polished or brushed sheet

variant C,D: polished or brushed sheet

variant E,F,G,H: polished or brushed sheet

variant I: polished or brushed sheet

variant J: polished or brushed sheet

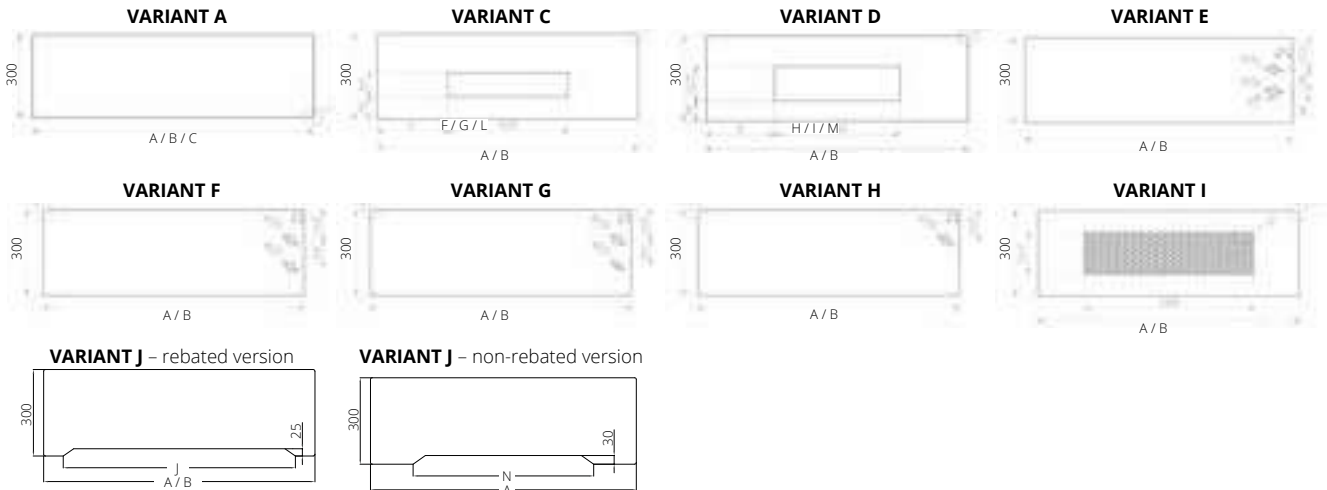

- **PANELS MADE OF BRUSHED OR POLISHED SHEET METAL**
- **PANEL EDGES CHAMFERED**
- **PANEL CORNERS ROUNDED - RADIUS 4x R3**

- VARIANT A:** solid panel
- VARIANT C:** perforation for PVC grille
- VARIANT D:** perforation for stainless steel grille
- VARIANT E:** perforation for cylinder lock
- VARIANT F:** perforation for master key lock
- VARIANT G:** perforation for WC lock
- VARIANT H:** perforation for "small lock"
- VARIANT I:** panel with ventilation holes
- VARIANT J:** panel for door leafs with ventilation undercut

DIMENSIONS: INTERIOR

width	VARIANT A (REBATED)		
	A	B	C
"30"	-	-	329
"40"	-	-	429
"50"	-	-	529
"60"	642	616	629
"70"	742	716	729
"80"	842	816	829
"90"	942	916	929
"90 plus"	952	926	-
"100"	1042	1016	1029
"110"	1142	1116	-

- A** panel on the collar side (hinge side)
- B** panel on the rebate side (opposite to hinges)
- C** panel on the collar side (hinge side), on the rebate side (opposite to hinges) - applies to passive door leaf (double-leaf door)

width	VARIANT C, D, E, F, G, H, I (REBATED)									
	A	B	D	E	F	G	H	I	J	
"60"*	642	616	156	143	108	95	100	87	506	
"70"	742	716	206	193	158	145	150	137	606	
"80"	842	816	256	243	208	195	200	187	706	
"90"	942	916	306	293	258	245	250	237	806	
"90 plus"	952	926	311	298	263	250	255	242	816	
"100"	1042	1016	356	343	308	295	300	287	906	
"110"	1142	1116	406	393	358	345	350	337	1006	
"120"	1242	1216	456	443	408	395	400	387	1106	

- A** panel on the collar side (hinge side)
- D** distance from the hole for the ventilation sleeve to the edge of the door leaf (hinge side)
- F** distance from the PVC grille to the edge of the door leaf (hinge side)
- H** distance from the grille to the edge of the door leaf (hinge side)
- J** width of the ventilation undercut
- B** panel on the rebate side (opposite to hinges)
- E** distance from the hole for the ventilation sleeve to the edge of the door leaf (opposite to hinges)
- G** distance from the PVC grille to the edge of the door leaf (opposite to hinges)
- I** distance from the grille to the edge of the door leaf (opposite to hinges)
- * does not apply to VARIANT I

DIMENSIONS: INTERIOR

width	VARIANT A, C, D, E, F, H, I (NON-REBATED)				
	A	K	L	M	N
"60"*	623	146,5	98,5	90,5	327
"70"	723	196,5	178,5	140,5	427
"80"	823	246,5	198,5	190,5	527
"90"	923	296,5	248,5	240,5	627
"90 plus"	948	309	261	253	657
"100"	1023	346,5	298,5	290,5	727
"110"	1123	396,5	348,5	340,5	827
"120"	1223	446,5	398,5	390,5	927

- A** width of the panel
- K** distance from the hole for the ventilation sleeve to the edge of the door leaf
- L** distance from the PVC grille to the edge of the door leaf
- M** distance from the grille to the edge of the door leaf
- N** width of the ventilation undercut
- * does not apply to VARIANT I

DIMENSIONS: REBATED EI30, EI30 PLUS, EI60 PLUS

width	VARIANT A, E (REBATED EI30, EI30 PLUS, EI60 PLUS)		
	A	B	C
"30"	-	-	334
"40"	-	-	434
"50"	-	-	534
"60"	646	622	634
"70"	746	722	734
"80"	846	822	834
"90"	946	922	934
"90 plus"	966	942	-
"100"	1046	1022	1034
"110"	1146	1122	1134

- A** panel on the collar side (hinge side)
- B** panel on the rebate side (opposite to hinges)
- C** panel on the collar side (hinge side), on the rebate side (opposite to hinges) - applies to passive door leaf (double-leaf door)

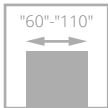

INTERIOR DOORS FOR ROOMS WITH **HEAT RECOVERY VENTILATION SYSTEM**



heat recovery ventilation shortening

The list of available doors with the possibility of heat recovery ventilation shortening is available on page 277.

Heat recovery ventilation shortening for ARCO, SEDO, MODO, VERI, EGRO, FORTIMO, SEMPRE, SEMPRE LUX, FORTIMO LUX, MONA, SLIM, SAMOS, UNITO doors (applies to standard heights), other models without extra charge.

The door leaves are 15 mm shorter than the standard height, i.e. 2005 mm (rebated system, non-rebated system and HARMONY opening outwards), 2015 mm (HARMONY opening inwards), the door frame remains at standard height.

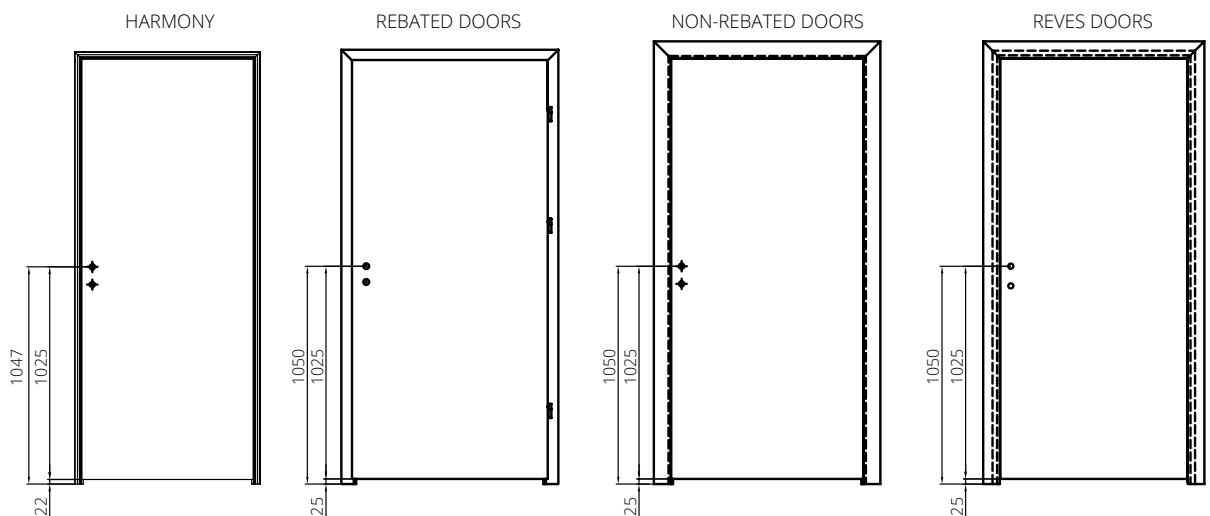

Doors for the heat recovery ventilation system are available at the price of a standard door set.

In the configurator www.drzwionline.pl the option to select the HEAT RECOVERY VENTILATION SHORTCUT is only possible when choosing the standard height of the door leaf and door frame as a set.

CAMBIO DOOR LEAFS WITH PICTOGRAM

CAMBIO DOOR LEAFS VERSION 00 WITH PICTOGRAMS

version 00 with pictogram version A, version B, version C, version D color RAL 9003

color range MONO1 MAT

color range MONO2 MAT

color range MONO3 MAT

Single-sided pictogram, always on the hinge side



STAINLESS STEEL PANEL WITH ICONS

STAINLESS STEEL PANEL WITH ICONS

BRUSHED STAINLESS STEEL PANEL WITH A THICKNESS OF 1.5 MM, WIDTH 150 MM WITH ICONS

It is possible to order a panel with one, two, or three icons presented in the photo.



ALUMINUM DECORS (TIARA, SONATA)



width 7.2 mm – versions W1-W8



width 25 and 10 mm – versions W09-W11

DECORATIVE ELEMENTS

It is recommended to use perforated or solid board filling.

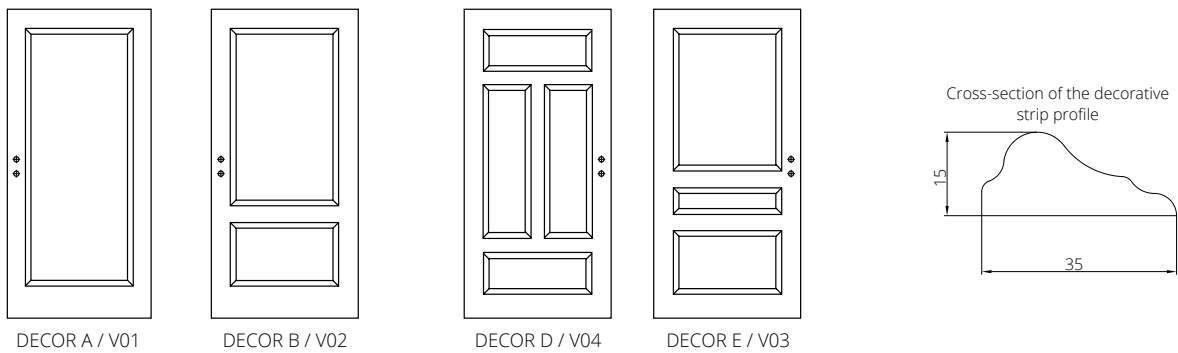

LAMISTONE	SILKSTONE	UNI MAT PLUS	PAINTED	VENEERED GROUP A	VENEERED GROUP B	VENEERED GROUP C, D
						SILKWOOD
						REALWOOD
			decor A			
			decor B			
			decor D			
			decor E			

ALUMINUM DECORS

color chrome matt, black

ALU DECORS FOR FIRE DOORS, CERBER PLUS, B-30, C-30, RC3, CERBER PLUS RC2 (rounded decor ends)

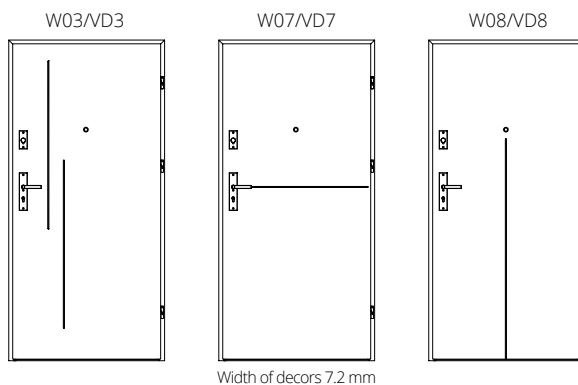

ALUMINUM STRIPS FOR FIRE DOORS, CERBER PLUS, CERBER PLUS RC2, B-30, C-30, RC3 (strip ends finished straight, flush with the edge of the door leaf) (does not apply to painted ones)

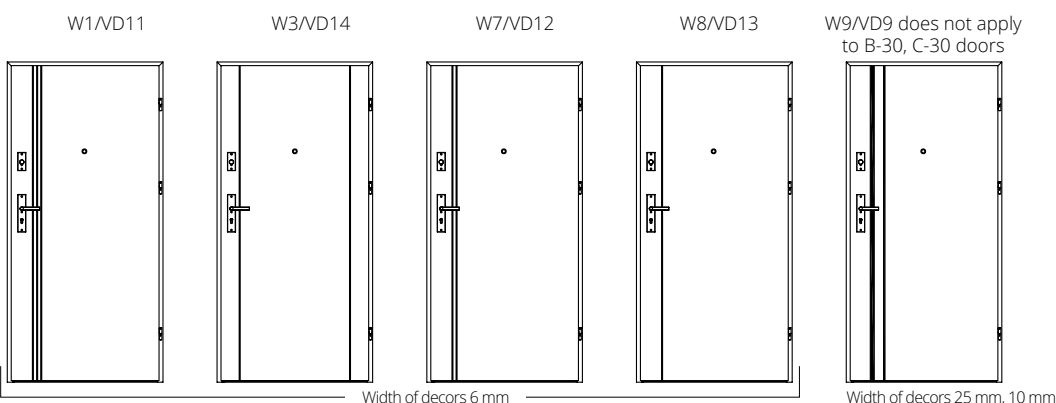

HANDLES FOR INTERIOR DOORS

ARCO

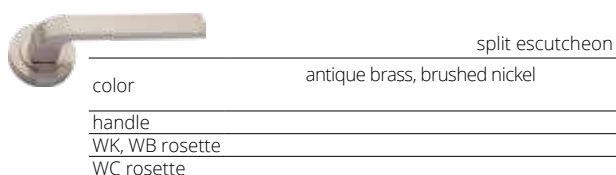

MISTICO

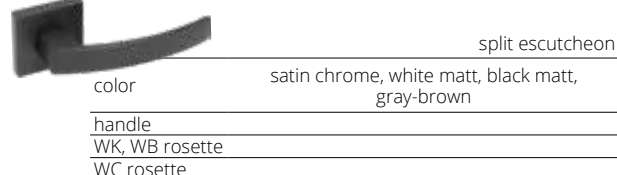

TELESTA

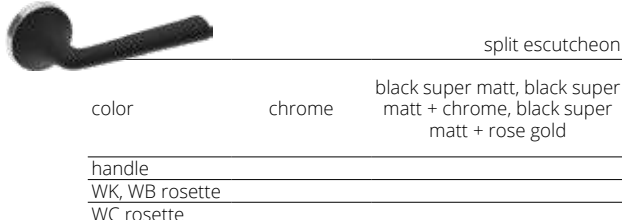

MAGNI

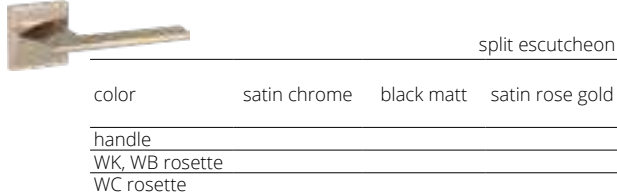

COPPER

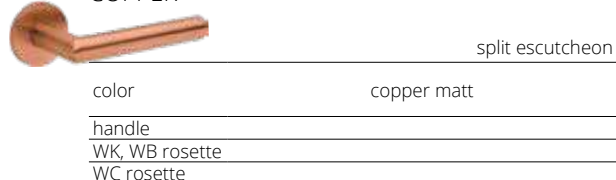

ORGANIC

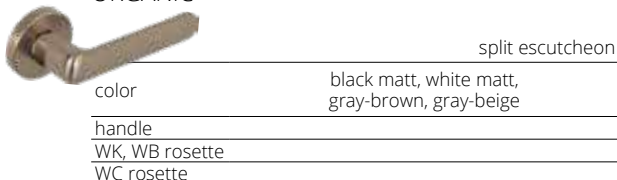

UNICO

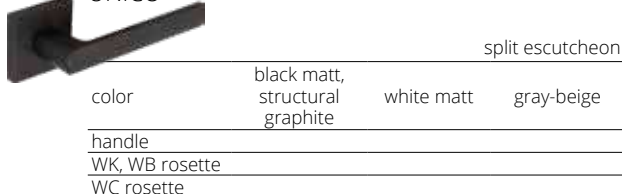

AUTUNNO

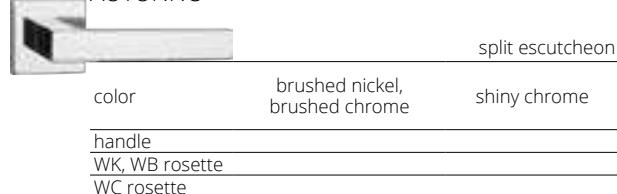
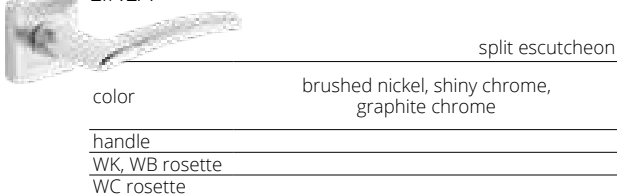

IMAGE-O INOX



LINEA



TOPAZ

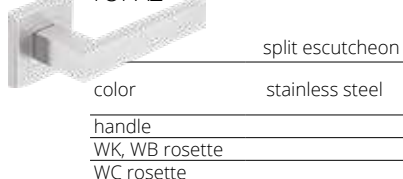

BOLD

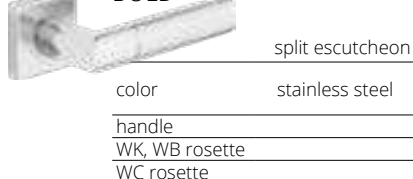

AGOSTO



ARABIS



IBIZA



LATON

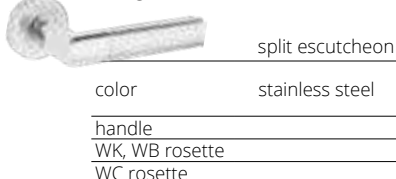

ESTATE

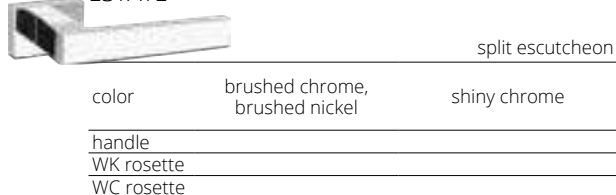

VERANO

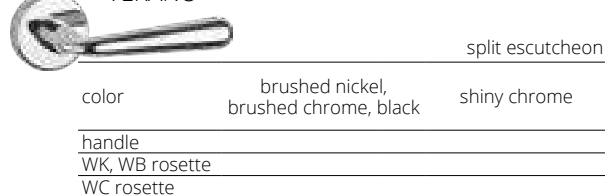

WK - for key, WB - for cylinder, WC - for bathroom lock

INVERNO
split escutcheon

color brushed nickel, brushed chrome, black

handle
WK, WB rosette
WC rosette

APRILE
split escutcheon

color shiny chrome, brushed chrome, brushed nickel

handle
WK, WB rosette
WC rosette

HALLEY
split escutcheon

color chrome/brushed nickel, antique brass

handle
WK, WB rosette
WC rosette

ANMI
split escutcheon

color gold matt, glossy gold

handle
WK, WB rosette
WC rosette

NIQUEL
split escutcheon

color stainless steel

handle
WK, WB rosette
WC rosette

HIGRO
split escutcheon

color stainless steel

handle + WK escutcheon
handle + WB escutcheon
handle + WC escutcheon

The handle + WC HIGRO escutcheon are intended only for HIGRO doors.

BERGENIA
split escutcheon

color black matt, polished chrome, satin chrome, polished gold, gold matt

handle
WK, WB rosette
WC rosette

PATINA
split escutcheon

color stainless steel

handle
WK, WB rosette
WC rosette

LUPINA
split escutcheon

color black matt, polished chrome, satin chrome

handle
WK, WB rosette
WC rosette

ARNICA
split escutcheon

color black matt, polished chrome, satin chrome

handle
WK, WB rosette
WC rosette

GALE (left, right)
long escutcheon spacing 72 mm

color chrome/brushed nickel, antique brass

handle + WK escutcheon
handle + WB escutcheon
handle + WC escutcheon
dedicated for doors in the rebated system

SATEN
split escutcheon

color stainless steel

handle
WK, WB rosette
WC rosette

NEW CLICK HANDLES

Instead of a traditional bathroom lock, the handle has a special button that allows you to lock the door from the inside and a knob that allows you to open the door from the outside in case of jamming.

NOVA CLICK
split escutcheon

color stainless steel, black

right handle
left handle

TOPAZ CLICK
split escutcheon

color stainless steel, black

right handle
left handle

CYLINDERS FOR INTERIOR DOORS

Cylinder size	Manufacturer	price per 1 pc.	rebated single-leaf door, Type A, Type B	rebated double-leaf door	non-rebated single-leaf door, Type A, Type B	non-rebated with electric strike	non-rebated double-leaf door	non-rebated double-leaf door Type A, Type B, HARMONY INVEST	Harmony, REVES	Lumen	Stallo
30x35	LOB		x	x			x				
30x30	LOB				x					x	x
30x40	LOB							x			
35x30	LOB					x			x		

WK - for key, WB - for cylinder, WC - for bathroom lock

HANDLES FOR ENTRANCE AND EXTERIOR DOORS



GARDA



ATLAS



OTERMA



OTERMA II

GARDA	INOX				BLACK			
	handle-handle	upper rosette	WILKA insert class 6 nickel-matt		handle-handle	upper rosette	WILKA insert class 6 black	
			opening inwards	opening outwards			opening inwards	opening outwards
CERBER PLUS, SEGURO PLUS, SEGURO								
CERBER PLUS RC2								
CERBER PLUS 37 dB								
B-30								
B-30 INVEST				-				-
C-30	standard equipment							
RC3								
RC3 INVEST								
RC3 INVEST 37 dB				-				-
RC3 INVEST 37 dB EI30				-				-
extra charge for insert with automatic recoding function 2+3	-	-			-	-		

ATLAS	INOX				BLACK			
	handle-handle	upper rosette	WILKA insert class 6 nickel-matt		handle-handle	upper rosette	WILKA insert class 6 black	
			opening inwards	opening outwards			opening inwards	opening outwards
CERBER PLUS, SEGURO, SEGURO PLUS								
CERBER PLUS RC2								
CERBER PLUS 37 dB								
B-30								
B-30 INVEST				-				-
C-30	standard equipment							
RC3								
RC3 INVEST								
RC3 INVEST 37 dB				-				-
RC3 INVEST 37 dB EI30				-				-
extra charge for insert with automatic recoding function 2+3	-	-			-	-		

OTTERMA	SILVER/INOX/TITANIUM				
	handle-handle	handle-knob	upper rosette	LOB insert classB silver	
				opening inwards	opening outwards
CERBER PLUS					
CERBER PLUS 37 dB					

OTTERMA II	SILVER/INOX/TITANIUM				
	handle-handle	handle-knob	upper rosette	LOB insert classB silver	
				opening inwards	opening outwards
CERBER PLUS					
CERBER PLUS 37 dB					

	GARDA						ATLAS					
	INOX/BLACK						INOX/BLACK					
	handle-handle			upper rosette	WILKA insert class 6 nickel-matt/black		handle-handle			upper rosette	WILKA insert class 6 nickel-matt/black	
class	spacing	screw length [mm]	screw length [mm]	opening inwards	opening outwards	class	spacing	screw length [mm]	screw length [mm]	opening inwards	opening outwards	
CERBER PLUS, SEGURO, SEGURO PLUS	RC3	72	65	65	30/35+30/35G	35/30+35/30G	RC2	72	60	60	35/35+35/35G	40/30+40/30G
CERBER PLUS RC2	RC3	72	65	65	30/35+30/35G	35/30+35/30G	RC2	72	60	60	35/35+35/35G	40/30+40/30G
CERBER PLUS 37 dB	RC3	72	65	65	30/35+30/35G	35/30+35/30G	RC2	72	60	60	35/35+35/35G	40/30+40/30G
B-30/C-30	RC3	72	65	65	35/40+35/40G	35/45+45/35G	RC3	72	75	75	35/40+35/40G	35/45+45/35G
B-30 INVEST	RC3	92	90	90	35/40+35/40G	-	RC3	92	75	75	35/40+35/40G	-
RC3	RC3	92	60	60	35/40+35/40G	40/30+40/30G	RC3	92	65	65	35/40+35/40G	40/30+40/30G
RC3 INVEST												
RC3 INVEST 37 dB	RC3	92	70	70	40/40+40/40G	-	RC3	92	75	75	40/40+40/40G	-
RC3 INVEST 37 dB EI30	RC3	92	70	70	40/40+40/40G	-	RC3	92	75	75	40/40+40/40G	-

	OTTERMA						OTTERMA II					
	SILVER/INOX/TITANIUM						SILVER/INOX/TITANIUM					
	handle-handle / handle-knob			upper rosette	LOB insert classB silver		handle-handle / handle-knob			upper rosette	LOB insert classB silver	
class	spacing	screw length [mm]	screw length [mm]	opening inwards	opening outwards	class	spacing	screw length [mm]	screw length [mm]	opening inwards	opening outwards	
CERBER PLUS	-	72	90	90	30/35+30/35G	30/40+40/30G	RC2	72	90	90	30/35+30/35G	30/40+40/30G
CERBER PLUS 37 dB	-	72	90	90	30/35+30/35G	30/40+40/30G	RC2	72	90	90	30/35+30/35G	30/40+40/30G

INSERTS FOR TECHNICAL DOORS



Cylinder size	Manufacturer	Sound-insulating TYPE A, TYPE B - rebated version	Sound-insulating TYPE A Duo, TYPE B Duo - non-rebated single-leaf door version	Sound-insulating TYPE A Duo, TYPE B Duo - non-rebated double-leaf door version	FR EI30 SR 32 dB, FR EI30 PLUS - rebated single-leaf door	FR EI30 SR 32 dB, FR EI30 PLUS - rebated double-leaf door	FR EI30 PLUS - non-rebated single-leaf door	FR EI30 PLUS - non-rebated double-leaf door	FR EI30 SR 42 dB, AKUSTIK 42 dB	FR EI60 PLUS - rebated single-leaf door	FR EI60 PLUS - rebated double-leaf door	FR EI60 PLUS - non-rebated single-leaf door, FR EI30 SR	FR EI60 PLUS - non-rebated double-leaf door	SR 37 dB	For panic bar	Higro	Gamma - single-leaf door	Deco Invest	G46
30x30	LOB		x													x			
30x35	LOB	x																x	
30x35G	LOB																		
30x40	LOB			x													x		
30Gx40	LOB																		
30x40G	LOB																		
35x40	LOB				x														
30x45	LOB					x		x											
35x45	LOB											x							
40x40	LOB													x					
35x35	LOB							x											
40x45	LOB								x	x	x		x						
9x30	LOB														x				
35x30	LOB																		x

DIMENSIONS - INTERIOR DOORS

		● STANDARD ○ ON REQUEST																
		* additional hinge required for extra charge ** Version V15A +20%		remarks							WIDTHS							
		1) does not apply to version V15 2) applies to version V01 3) glazing design as in "90" 4) applies to version W01, W01S		lower by 50 mm	lower by 100 mm	higher by 50 mm	higher by 100 mm	higher by 150 mm	higher by 200 mm	higher by 300 mm	higher by 400 mm	"60"	"70"	"80"	"90"	"+90"	"100"	"110"
ADORE - p. 96		●	●			+10%*	+10%*	+20%*	+20%*	+30%*	+40%*	●	●	●	●	●	+10%	-
ARCO - p. 58		●	●			-	-	-	-	-	-	●	●	●	●	●	-	-
CAMBIO - p. 122		●	●			+10%*	+10%*	+20%*	+20%*	+30%*	+40%*	●	●	●	●	●	+10%	+20% ³⁾
CREATO - p. 92		●	●			+10%*	+10%*	+20%*	+20%*	-	-	●	●	●	●	●	+10%	-
DECO - p. 86		●	●			+10%*	+10%*	+20%*	+20%*	+30%*	+40%*	●	●	●	●	●	+10%	+20%
DECO EGGER - p. 88		●	●			+10%*	+10%*	○	○	○	○	●	●	●	●	●	○	○
DECO LUX - p. 152		●	●			+10%*	+10%*	+20%*	+20%*	+30%*	+40%*	●	●	●	●	●	+20%	+40%
EGRO - p. 54	up to 5 pcs. over 5 pcs.	●	-			+15%*	+15%*	+25%*	+25%*	-	-	●	●	●	●	-	-	-
EMPORE - p. 98		●	-			+10%*	+10%*	+20%*	+20%*	-	-	●	●	●	●	●	-	-
ESPINA - p. 154		●	● ¹⁾			+10%*	+10%*	+20%*	+20%*	+30%*	+40%*	●	●	●	●	●	+20%	+40% ¹⁾
ESTATO - p. 126	A01, A02 B1, B2, B3	●	●			+10%*	+10%*	+20%*	+20%*	-	-	●	●	●	●	●	+10%	-
ESTATO LUX - p. 160	A01, A02 B1, B2, B3	●	●			+10%*	+10%*	+20%*	+20%*	-	-	●	●	●	●	●	+20%	-
ESTO - p. 56		●	-			-	-	-	-	-	-	●	●	●	●	●	-	-
ETIUDA - p. 104	A01, A02 B0, B1	●	●			+10%*	+10%*	+20%*	+20%*	-	-	●	●	●	●	●	+10%	-
FIORD - p. 134		●	-			+10%*	+10%*	+20%*	+20%*	-	-	●	●	●	●	●	+10%	+20%
FORTIMO - p. 74	up to 5 pcs. over 5 pcs.	●	-			+15%*	+15%*	+25%*	+25%*	-	-	● ³⁾	●	●	●	●	+10%	-
FORTIMO LUX - p. 144	up to 5 pcs. over 5 pcs.	●	-			+10%*	+10%*	+20%*	+20%*	-	-	● ³⁾	●	●	●	●	+10%	-
FORTO - p. 64		●	-			+15%*	+15%*	+25%*	+25%*	-	-	● ³⁾	●	●	●	●	+20%	-
GALIO - p. 22		○	○			○	●	-	-	-	-	-	●	●	●	●	-	-
GALIO PIVOT - p. 28		○	○			○	●	-	-	-	-	-	●	●	●	●	-	-
HAPTIC - p. 82		●	●			+10%*	+10%*	+20%*	+20%*	+30%*	+40%*	●	●	●	●	●	+10%	+20% ³⁾
HARMONY INVEST - p. 16		●	○			○	○	○	○	○	○	●	●	●	●	●	+10%	+20%
HARMONY INVEST PRO - p. 18		●	○			○	○	○	○	○	○	●	●	●	●	●	+10%	+20%
HARMONY MIRROR - p. 14		○	○			-	●	-	●	-	●	●	●	●	●	●	-	-
HARMONY SYSTEM POL-SKONE - p. 12		●	●			○	○	○	○	○	○	●	●	●	●	●	○	○
IMPULS - p. 84	not applicable to versions W13 and W14	●	●			+10%*	+10%*	+20%*	+20%*	+30%*	+40%*	●	●	●	●	●	+10%	+20% ³⁾
INTERSOLID - p. 146	up to 5 pcs. over 5 pcs.	●	-			+10%*	+10%*	+25%*	+25%*	-	-	●	●	●	●	●	+20%	-
INTERSOLID II - p. 148	up to 5 pcs. over 5 pcs.	●	-			+10%*	+10%*	+25%*	+25%*	-	-	●	●	●	●	●	+20%	-
INVERNO - p. 90		●	●			+10%*	+10%*	+20%*	+20%*	-	-	●	●	●	●	●	+10%	+20%
KINGSTONE - p. 150		●	-			+10%*	+10%*	+20%*	+20%*	-	-	●	●	●	●	●	+20%	-
LAURA - p. 68	up to 5 pcs. over 5 pcs.	●	-			+20%*	+20%*	-	-	-	-	●	●	●	●	●	-	-
LUMEN - p. 164		●	-			+15%*	+15%*	-	-	-	-	●	●	●	●	●	-	-
LUMEN LOFT - p. 166		●	-			-	-	-	-	-	-	●	●	●	●	●	-	-
LUMO - p. 26		○	○			○	●	-	-	-	-	●	●	●	●	●	-	-
MAESTO - p. 100		●	●			+10%*	+10%*	+20%*	+20%*	-	-	●	●	●	●	●	+10%	-
MAGRO - p. 66		●	-			-	-	-	-	-	-	●	●	●	●	●	-	-
MODENA - p. 118		●	-			+10%*	+10%*	+20%*	+20%*	-	-	●	●	●	●	●	+10%	-
MODERN - p. 108		●	-			+10%*	+10%*	+20%*	+20%*	-	-	●	●	●	●	●	+10%	-
MODESTO - p. 112		●	●			+10%*	+10%*	+20%*	+20%*	-	-	●	●	●	●	●	+10%	-
MODO - p. 52	up to 5 pcs. over 5 pcs.	●	-			+15%*	+15%*	+25%*	+25%*	-	-	●	●	●	●	●	-	-
MONA - p. 78	up to 5 pcs. over 5 pcs.	●	-			+10%*	+10%*	+20%*	+20%*	-	-	● ⁴⁾	●	●	●	●	+10%	-
PALAZZO - p. 114		●	●			+10%*	+10%*	-	-	-	-	● ⁴⁾	●	●	●	●	+10%	-
PASSO - p. 80	up to 5 pcs. over 5 pcs.	●	-			+20%*	+20%*	-	-	-	-	●	●	●	●	●	-	-
PRINCESTONE - p. 120		●	-			+15%*	+15%*	-	-	-	-	●	●	●	●	●	-	-
RIFLO - p. 138		●	-			+10%*	+10%*	+20%*	+20%*	-	-	●	●	●	●	●	+10%	-
ROYALE - p. 136		●	-			+10%*	+10%*	+20%*	+20%*	+30%*	+40%*	●	●	●	●	●	+10%	-
SALEA - p. 102		●	●			+10%*	+10%*	+20%*	+20%*	-	-	●	●	●	●	●	+10%	-
SAMOS - p. 62	up to 5 pcs. over 5 pcs.	●	-			+25%*	+10%*	+25%*	+20%*	-	-	●	●	●	●	●	-	-
SEDO - p. 48	up to 5 pcs. over 5 pcs.	●	-			+20%*	+10%*	+20%*	+20%*	-	-	●	●	●	●	●	-	-
SEMPRE - pp. 70 and 72	up to 5 pcs. over 5 pcs.	●	-			+15%*	+15%*	+25%*	+25%*	-	-	●	●	●	●	●	-	-
SEMPRE LUX - pp. 140 and 142	up to 5 pcs. over 5 pcs.	●	-			+10%*	+10%*	+25%*	+25%*	-	-	●	●	●	●	●	+20%	-
SENTO - p. 130		●	-			+10%*	+10%*	-	-	-	-	●	●	●	●	●	-	-
FOLDING - p. 162		●	-			+10%*	+10%*	+20%*	+20%*	-	-	●	●	●	●	●	-	-
SLIM - p. 76		●	-			+10%*	+10%*	-	-	-	-	●	●	●	●	●	+10%	-
SONATA - p. 94		●	●			+10%*	+10%*	+20%*	+20%*	-	-	●	●	●	●	●	+10%	-
SONATA LUX - p. 158		●	●			+10%*	+10%*	+20%*	+20%*	-	-	●	●	●	●	●	+20%	-
STALIO - p. 34		○	○			○	-	-	-	-	-	●	●	●	●	●	-	-
SUBITO - p. 124		●	●			+10%*	+10%*	+20%*	+20%*	+30%*	+40%*	●	●	●	●	●	+10%	+20% ³⁾
SUBLIME - p. 132		●	●			+10%*	+10%*	+20%*	+20%*	+30%*	+40%*	●	●	●	●	●	+10%	+20% ³⁾
TEO - p. 156		●	●			+10%*	+10%*	+20%*	+20%*	+30%*	+40%*	●	●	●	●	●	+20%	-
TIARA - p. 128		●	●			+10%*	+10%*	+20%*	+20%*	-	-	●	●	●	●	●	+10%	-
UNITO - p. 60		●	-			-	-	-	-	-	-	●	●	●	●	●	-	-
VERI - p. 50	up to 5 pcs. over 5 pcs.	●	-			+15%*	+15%*	+25%*	+25%*	-	-	●	●	●	●	●	-	-
VERTIGO - p. 116		●	-			+10%*	+10%*	+20%*	+20%*	-	-	●	●	●	●	●	+10%	-
VILANO - p. 110		●	-			+10%*	+10%*	+20%*	+20%*	-	-	●	●	●	●	●	+10%	-
VISIO - p. 40		●	-			-	-	-	-	-	-	●	●	●	●	●	-	-
VISIO LUX - p. 42		●	-			-	-	-	-	-	-	●	●	●	●	●	-	-
VISIO M - p. 44		●	-			-	-	-	-	-	-	●	●	●	●	●	-	-
ZENN - p. 106		●	● ²⁾			+10%*	+10%*	+20%*	+20%*	+30%* ²⁾	+40%* ²⁾	●	●	●	●	● ²⁾	+10%**	-

DIMENSIONS - TECHNICAL DOORS

FR EI30, EI 30 PLUS, EI 60 PLUS, B-30, C-30, RC3, SR 37 dB, SR 42 dB, CERBER PLUS, GAMMA WOODEN DOOR FRAME

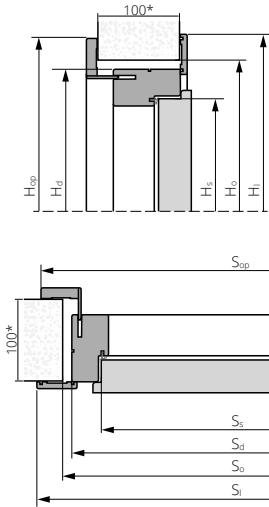

FR EI30 (DOUBLE-SIDED ADJUSTMENT)

SOUNDPROOF TYPE A, B WOODEN DOOR FRAME

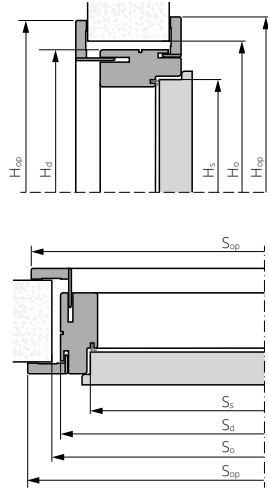

SOUNDPROOF TYPE A, B FIXED WOODEN DOOR FRAME

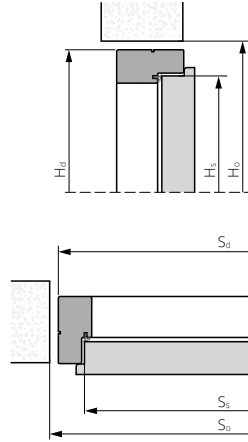

EI30 PLUS, EI60 PLUS WOODEN DOOR FRAME

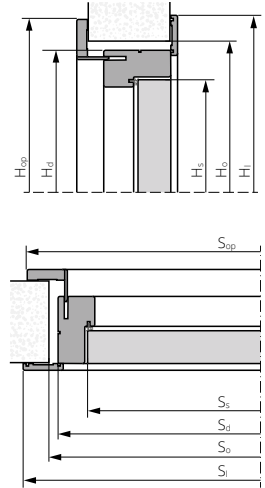

SOUNDPROOF TYPE A, B NON-REBATED WOODEN DOOR FRAME

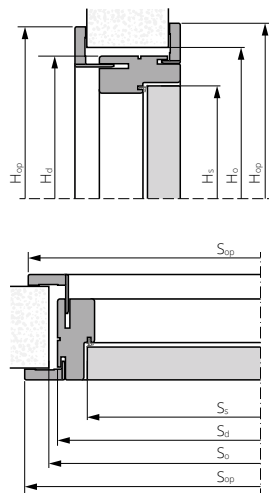

SOUNDPROOF TYPE A, B ADJUSTABLE DIN ZP DOOR FRAME

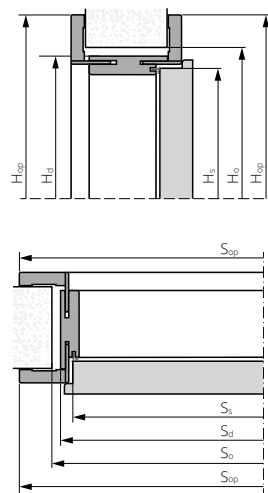

EI30 PLUS, EI60 PLUS, RC3, GAMMA, DECO INVEST, CERBER PLUS FIXED METAL DOOR FRAME

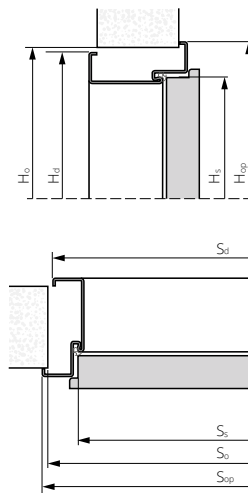

EI30 PLUS, EI60 PLUS ADJUSTABLE METAL DOOR FRAME

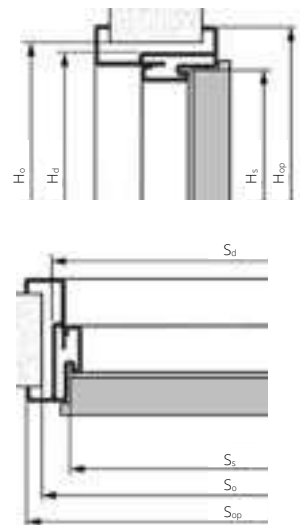

SOUNDPROOF TYPE A, B, DECO INVEST, GAMMA ADJUSTABLE METAL DOOR FRAME

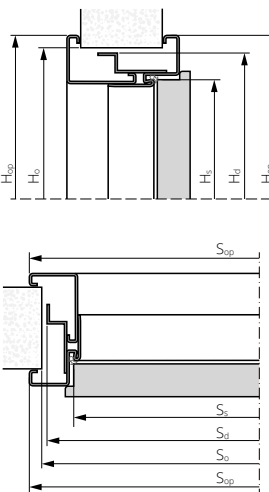

EI30 PLUS, EI60 PLUS, HIGRO FIXED METAL DOOR FRAME

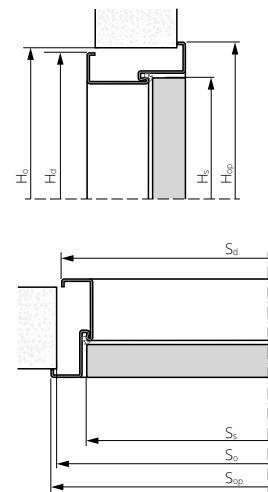

EI30 PLUS, EI60 PLUS ADJUSTABLE METAL DOOR FRAME

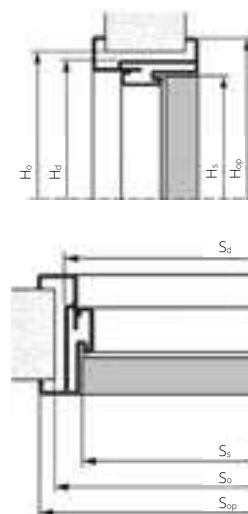

SWING DOOR FIXED WOODEN DOOR FRAME

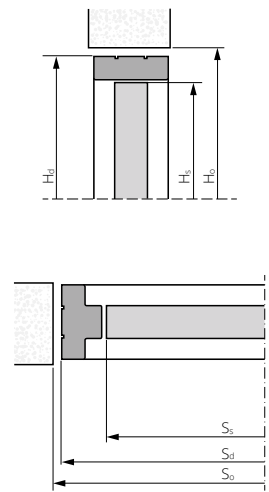

* in the case of EI60 PLUS door, width 120 mm

DIMENSIONS - TECHNICAL DOORS

Type of door	Type of door frame	Size	Ss	Hs	Sd	Hd	Sop Sc	Hop Hc	Sop with panel	Hop with panel	Sl	Hi	So	Ho				
FIRE-RESISTANT DOOR	EI30 PLUS EI60 PLUS Acoustic 32 dB rebated version	wooden	"60"	624	2026	712	2075	2115	820	2128	823	2130	740	2090				
			"70"	724		812			894		920		923		840			
			"80"	824		912			994		1020		1023		940			
			"90"	924		1012			1094		1120		1123		1040			
			"90" plus	944		1032			1114		1140		1143		1060			
			"100"	1024		1112			1194		1220		1223		1140			
		"90" plus + "30"	944 366	1372	1454	1480	1483	1400										
		"90" + "90"	924 936	1952	2034	2060	2063	1980										
		"100" + "100"	1024 1036	2152	2234	2260	2263	2180										
		adjustable metal	"60"	624	661	724	-	665*										
			"70"	724	761	824	-	765*										
			"80"	824	861	924	-	865*										
	"90"		924	961	1024	-	965*											
	"90" plus		944	981	1044	-	985*											
	"100"		1024	1061	1124	-	1065*											
	fixed metal	"90" plus + "30"	944 366	1319	1382	-	1325*											
		"90" + "90"	924 936	1899	1962	-	1905*											
		"100" + "100"	1024 1036	2099	2162	-	2105*											
		"60"	624	660	704	-	680*											
		"70"	724	760	804	-	780*											
		"80"	824	860	904	-	880*											
	FIRE-RESISTANT DOOR	FR EI30	wooden	"60"	624	2026	712	2075	2115	820	2128	823	2130	740	2090			
				"70"	724		812			894		920		923		840		
				"80"	824		912			994		1020		1023		940		
				"90"	924		1012			1094		1120		1123		1040		
				"90" plus	944		1032			1114		1140		1143		1060		
				"100"	1024		1112			1194		1220		1223		1140		
			"90" plus + "30"	944 366	1372	1454	1480	1483	1400									
			"90" + "90"	924 936	1952	2034	2060	2063	1980									
			"100" + "100"	1024 1036	2152	2234	2260	2263	2180									
			FR EI30 double-sided adjustment	"60"	624	712	794	820	815	740								
				"70"	724	812	894	920	915	840								
				"80"	824	912	994	1020	1015	940								
		"90"		924	1012	1094	1120	1115	1040									
		"90" plus		944	1032	1112	1140	1135	1060									
		"100"		1024	1112	1194	1220	1215	1140									
FIRE-RESISTANT DOOR		EI30 PLUS EI60 PLUS non-rebated version	wooden	"60"	625	2026	712	2075	2115	820	2128	823	2130	740	2090			
				"70"	725		812			894		920		923		840		
				"80"	825		912			994		1020		1023		940		
				"90"	925		1012			1094		1120		1123		1040		
				"90" plus	985		1072			1154		1180		1183		1100		
				"100"	1025		1112			1194		1220		1223		1140		
			"90" plus + "30"	985 325	1390	1472	1498	1501	1420									
			"90" + "90"	925 925	1930	2112	2038	2041	1960									
			"100" + "100"	1025 1025	2130	2212	2238	2241	2160									
			adjustable metal	"60"	625	660	724	-	665*									
				"70"	725	760	824	-	765*									
				"80"	825	860	924	-	865*									
		"90"		925	960	1024	-	965*										
		"90" plus		985	1020	1084	-	1025*										
		"100"		1025	1060	1124	-	1065*										
		fixed metal	"90" plus + "30"	985 325	1336	1400	-	1340*										
			"90" + "90"	925 925	1876	1940	-	1880*										
			"100" + "100"	1025 1025	2076	2140	-	2080*										
			"60"	625	660	724	-	680*										
			"70"	725	760	824	-	780*										
			"80"	825	860	924	-	880*										
	FIRE-RESISTANT DOOR	FR EI30 SR	wooden	"60"	625	2025	712	2075	2115	820	2128	823	2130	740	2090			
				"70"	725		812			894		920		923		840		
				"80"	825		912			994		1020		1023		940		
				"90"	925		1012			1094		1120		1123		1040		
				"90" plus	985		1072			1154		1180		1183		1100		
				"100"	1025		1112			1194		1220		1223		1140		
			INTERIOR ENTRANCE DOOR	B-30 C-30 RC3	wooden	"80"	792	2022	880	2075**	2115	988	2128	991	2130	910	2090	
						"90"	892		980			1062		1088		1091		1010
						"90" plus	924		1012			1094		1120		1123		1040
						"90" plus	944		1032			1114		1140		1143		1060
						"100"	1024		1112			1194		1220		1223		1140
						RC 3 INVEST	fixed metal		"80"			824		860		924		-
		"90"			924			960	1024	-	985							
		"90" plus			944			980	1044	-	1005							
		fixed wooden			"100"		1024	1060	1124	-	1085							
"80"					818		895	976	1002	925								
"85"					778		855	936	962	961								
CERBER PLUS CERBER PLUS RC2		metal			"90"	918	995	1076	1102	1101	1101	2121	1101	2120	1025	2080		
				"90" plus	928	1005	1086	1112	1111	1035								
				"100"	1018	1095	1176	1202	1201	1125								
		RC 3 INVEST 37dB		metal	"80"	818	871	917	-	885								
					"90"	918	971	1017	-	985								
					"90" plus	928	981	1027	-	995								
RC 3 INVEST 37dB		metal		"100"	1018	1071	1117	-	1085									
				"80"	824	874	920	-	900									
				"90"	924	974	1020	-	1000									
RC 3 INVEST 37dB		metal		"90" plus	944	994	1040	-	1020									
				"100"	1024	1074	1120	-	1100									

Type of door		Type of door frame	Size	Ss	Hs	Sd	Hd	Sop Sc	Hop Hc	Sop with panel	Hop with panel	SI	HI	So	Ho		
ACOUSTIC DOOR	SR 37 dB	wooden	"80"	824	2022	912	2075	994	2115	1020	2128	1023	2130	940	2090		
			"90"	924		1012		1094		1120		1123		1040			
			"100"	1024		1112		1194		1220		1223		1140			
	AKUSTIC 42 dB	fixed metal	"80"	824	2026	876	2057	922	2080	-	-	-	-	895	2070		
			"90"	924		976		1022		-		-		995			
			"90" plus	944		996		1042		-		-		1015			
		adjustable metal	"100"	1024	1076	1122	-	-	1095								
			"80"	824	891	922	2080	-	900								
			"90"	924	991	1022			1000								
	"90" plus	944	1011	1042	1010												
	TYPE A TYPE B - rebated version	metal adjustable	"100"	1024	2020	1091	2062	1122	2078	-	-	-	-	1100	2065		
			"80"	818		884		917		-		-		889			
			"80" plus	828		894		927		-		-		899			
			"90"	918		984		1017		-		-		989			
			"90" plus	928		994		1027		-		-		999			
			"100"	1018		1084		1117		-		-		1089			
		wooden adjustable	"80"	818	895	976	2020	2067	1002	2107	-	2120	-	2118	915	2080	
			"80" plus	828	905	986			1012						1008		925
			"90"	918	995	1076			1102						1098		1015
			"90" plus	928	1005	1086			1112						1108		1025
		wooden fixed	"100"	1018	1095	1176	2020	2067	-	-	-	-	-	-	1115	2080	
			"80"	818	895	-			-						915		
			"80" plus	828	905	-			-						925		
			"90"	918	995	-			-						1015		
		DIN adjustable	"90" plus	928	1005	-	2020	2043	-	2093	-	-	-	-	1025	2055	
			"100"	1018	1095	-			-						1115		
			"80"	818	846	946			-						-		875
			"80" plus	828	856	956			-						-		885
	"90"		918	946	1046	-			-						975		
	"90" plus		928	956	1056	-			-						985		
	TYPE A Duo TYPE B Duo - non-rebated version	wooden adjustable	"100"	1018	1046	2020	2067	1146	2127	-	2141	-	2139	1075	2080		
			"80"	825	901			1022						1048		1044	925
			"80" plus	850	926			1047						1073		1069	950
			"90"	925	1001			1122						1148		1144	1025
			"90" plus	950	1026			1147						1173		1169	1050
			"100"	1025	1101			1222						1248		1244	1125
		wooden fixed	"90" + "90"	925 925	1916	2037	2020	2067	2237	-	-	-	-	-	1940	2080	
			"100" + "100"	1025 1025	2116	2237			2263						2259		2140
			"80"	825	901	-			-						-		925
			"80" plus	850	926	-			-						-		950
"90"			925	1001	-	-			-						1025		
"90" plus			950	1026	-	-			-						1050		
HIGRO	metal fixed	"100"	1025	1072	2022	2053	1102	2068	-	-	-	-	1085	2060			
		"80"	825	890			922						-		-	895	
		"90"	925	990			1022						-		-	995	
		"90" plus	950	1015			1047						-		-	1020	
	metal adjustable	"100"	1025	1090	1122	2022	2062	1122	2078	-	-	-	-	1095	2065		
		"80"	825	890	922			-						-		895	
	GAMMA	wooden	"80"	818	895	2020	2067	976	2108	-	2121	-	2120	915	2080		
			"90"	918	995			1076						1102		1101	1015
			"100"	1018	1095			1176						1202		1201	1115
			"110"	1118	1195			1276						1302		1301	1215
			"90" + "90"	918 931	1930			2011						2037		2036	1950
			"100" + "100"	1018 1031	2130			2211						2237		2236	2150
adjustable metal		"110" + "110"	1118 1131	2330	2411	2437	2436	2350									
		"80"	818	884	917	2020	2062	978	2078	-	-	-	-	890	2065		
		"90"	918	984	1017			-						-		990	
		"100"	1018	1084	1117			-						-		1090	
		"110"	1118	1184	1217			-						-		1190	
		"90" + "90"	918 931	1925	1951			-						-		1925	
"100" + "100"		1018 1031	2125	2151	-			-						2125			
fixed metal		"110" + "110"	1118 1131	2225	2351	2020	2055	2351	2068	-	-	-	-	2325	2060		
		"80"	818	871	897			-						-		881	
		"90"	918	971	997			-						-		981	
		"100"	1018	1071	1097			-						-		1081	
		"110"	1118	1171	1197			-						-		1181	
	"90" + "90"	918 931	1905	1931	-			-						1915			
DECO INVEST	fixed metal	"100" + "100"	1018 1031	2105	2020	2055	2131	2068	-	-	-	-	2115	2060			
		"110" + "110"	1118 1131	2305			2331						-		-	2315	
		"70"	721	774			800						-		-	785	
		"80"	821	874			900						-		-	885	
		"90"	921	974			1000						-		-	985	
		"90" plus	931	984			1010						-		-	995	
	adjustable metal	"100"	1021	1074	1100	2020	2062	1120	2078	-	-	-	-	1085	2065		
		"110"	1121	1174	1200			-						-		1185	
		"90" + "90"	921 934	1908	1934			-						-		1918	
		"100" + "100"	1021 1034	2108	2134			-						-		2118	
		"80"	821	888	920			-						-		892	
		"90"	921	988	1020			-						-		992	
DOUBLE-ACTION DOORS	wooden fixed	"90" plus	931	998	2033	2076	1030	-	-	-	-	-	1002	2090			
		"100"	1021	1088			1120						-		-	1092	
		"110"	1121	1188			1220						-		-	1192	
		"90" + "90"	921 934	1922			1954						-		-	1925	
		"100" + "100"	1021 1034	2122			2154						-		-	2125	
		"60"	644	769			-						-		-	795	
wooden fixed	"70"	744	869	-	2033	2076	-	-	-	-	-	-	895	2090			
	"80"	844	969	-			-						995				
	"90"	944	1069	-			-						1095				
	"60" + "60"	644 644	1418	-			-						1445				
	"70" + "70"	744 744	1618	-			-						1645				
	"80" + "80"	844 844	1818	-			-						1845				
	"90" + "90"	944 944	2018	-			-						2045				

Ss - width of the door leaf

Hs - door leaf height

Sd - door width

Hd - door height

Sop - door width on the outer side of the trim 60 mm

Hop - door height on the outer side of the trim 60 mm

** possibility to order doors with a height of 2000 mm, 1950 mm

Sop with panel - width on the outer side of the trim for ranges with an extension panel

Hop with panel - height on the outer side of the trim for ranges with an extension panel

SI - door width after trims/mouldings 60 mm on the hinge side

HI - door height after trim/moulding 60 mm on the hinge side

So - recommended installation opening width

Ho - recommended installation opening height

* necessity to chisel the wall for protective boxes

DOOR LEAF DIMENSIONS INTERIOR

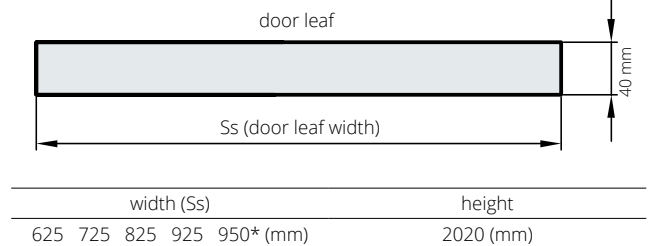
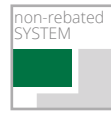
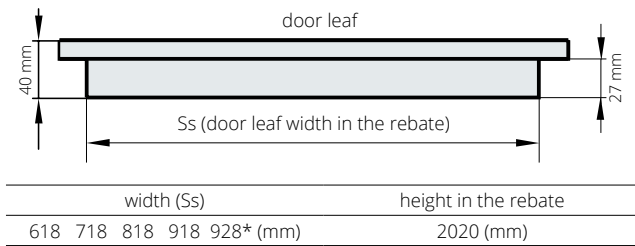

*190 plus" width
Full dimensional range of interior doors with door frames – pp. 240-248

HANDLE HEIGHT, DOORS

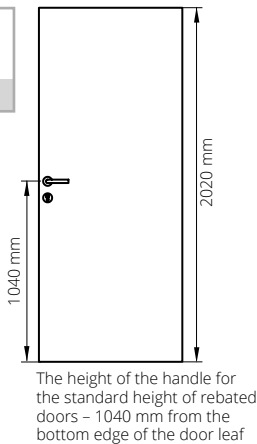

SYMMETRY ABOVE ALL
 UNIFIED DOOR HEIGHT,
 HEIGHTS OF TRIMS
 ON THE OUTER SIDE
 AND HANDLES IN
 THE REBATED, NON-
 REBATED, HIDDEN
 DOOR AND REVERSE
 REBATE REVES SYSTEM.

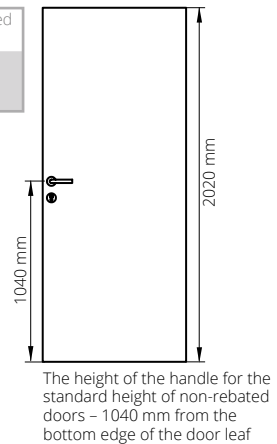

single-leaf rebated door – opening directions

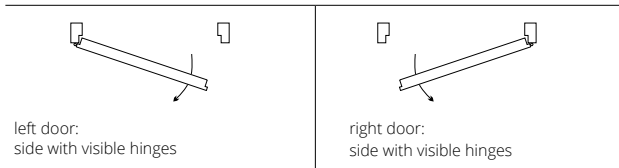

double-leaf rebated door – opening directions

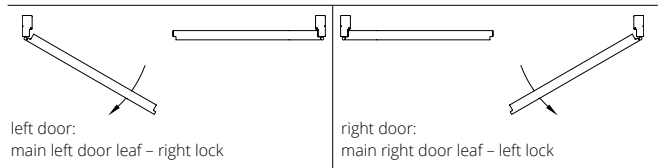

single-leaf non-rebated door – opening directions

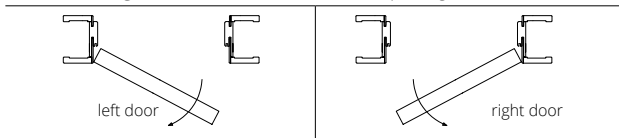

single-leaf door in the REVES system – opening directions

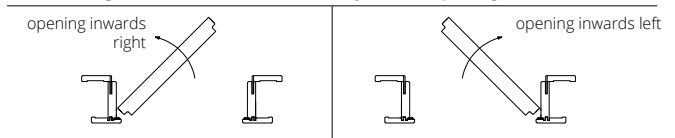

HARMONY door – opening directions

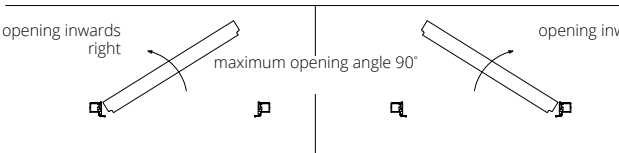

HARMONY door – opening directions

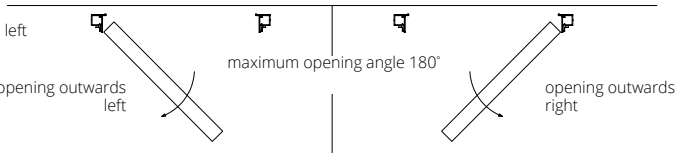

CLEARANCE BETWEEN THE DOOR LEAF AND THE FLOOR

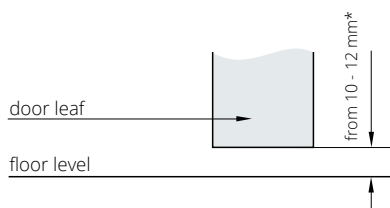

*for HARMONY door leaves the clearance is 7 mm

version with Swiss threshold (option)

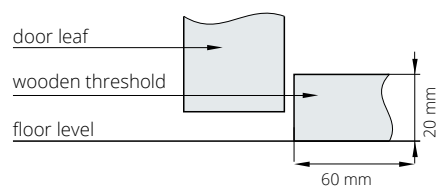

The dimensions for interior entrance and external doors can be found on the pages dedicated to individual door models.

IMPORTANT USER INFORMATION

REGARDING WIDTH 90 PLUS

FR EI30, EI30 PLUS EI60 PLUS

wooden door frame FR EI30, EI30 PLUS

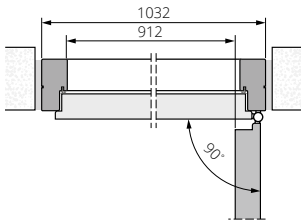

fixed metal door frame
EI30 PLUS

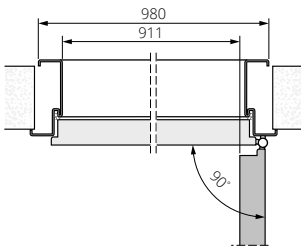

wooden door frame
EI60 PLUS

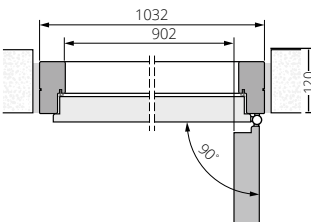

fixed metal door frame
EI60 PLUS

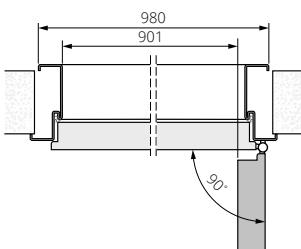

EI30 PLUS, EI60 PLUS

wooden non-rebated door frame
EI30 PLUS

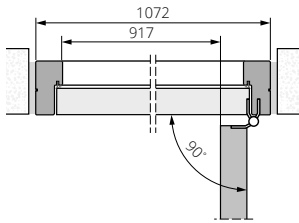

fixed metal non-rebated door
frame EI30 PLUS

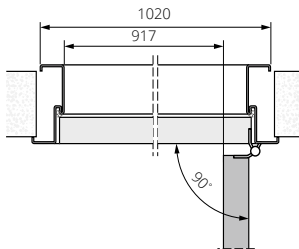

wooden non-rebated door frame
EI60 PLUS

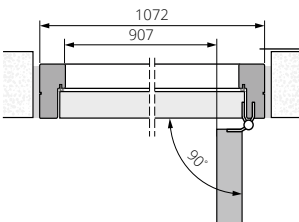

fixed metal non-rebated door
frame EI60 PLUS

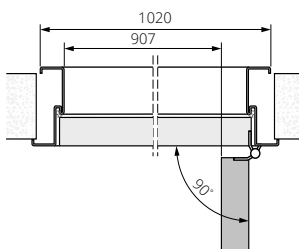

B-30, C-30, SR 37 dB, RC3, FR EI30, SR 42 dB

wooden door frame
B-30, C-30

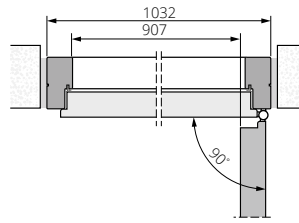

metal door frame
RC3

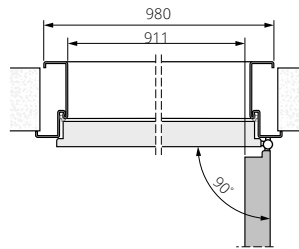

wooden door frame
RC3

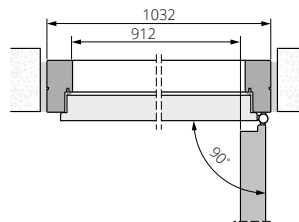

wooden door frame
FR EI30, SR 42 dB

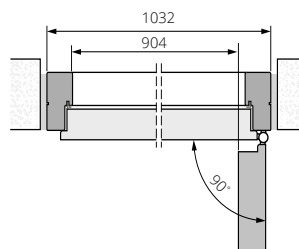

CERBER PLUS, DECO INVEST, SEGURO, SEGURO PLUS

wooden door frame
CERBER PLUS

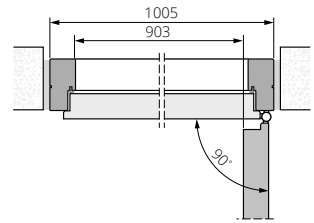

metal door frame
DECO INVEST

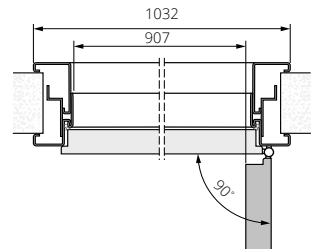

metal door frame
CERBER PLUS

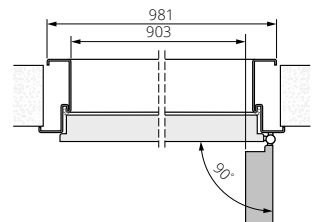

SOUNDPROOF TYPE A, TYPE B, INTERIOR

wooden door frame
TYPE A, B, interior with 3rd class of
mechanical strength, interior

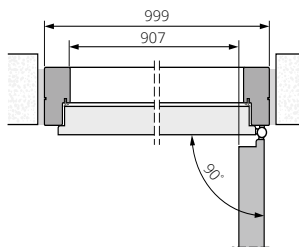

metal door frame
TYPE A, B, interior

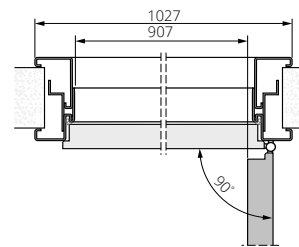

ZP door frame
TYPE A, B, interior with 3rd class of
mechanical strength, interior

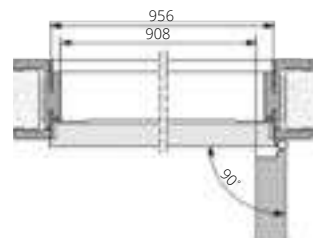

DUO INTERIOR DOOR

ZD door frame

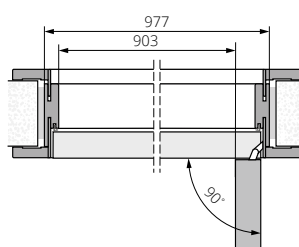

metal door frame

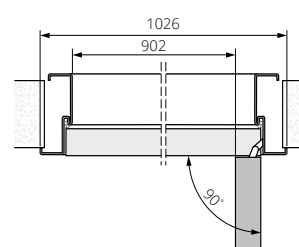

DUO wooden door frame
TYPE A, B

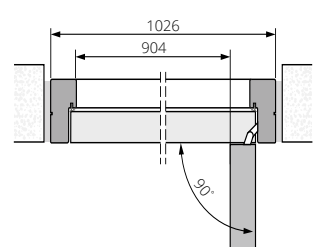

GLASS IN THE DOOR

See on which side the matt side of the glass is located

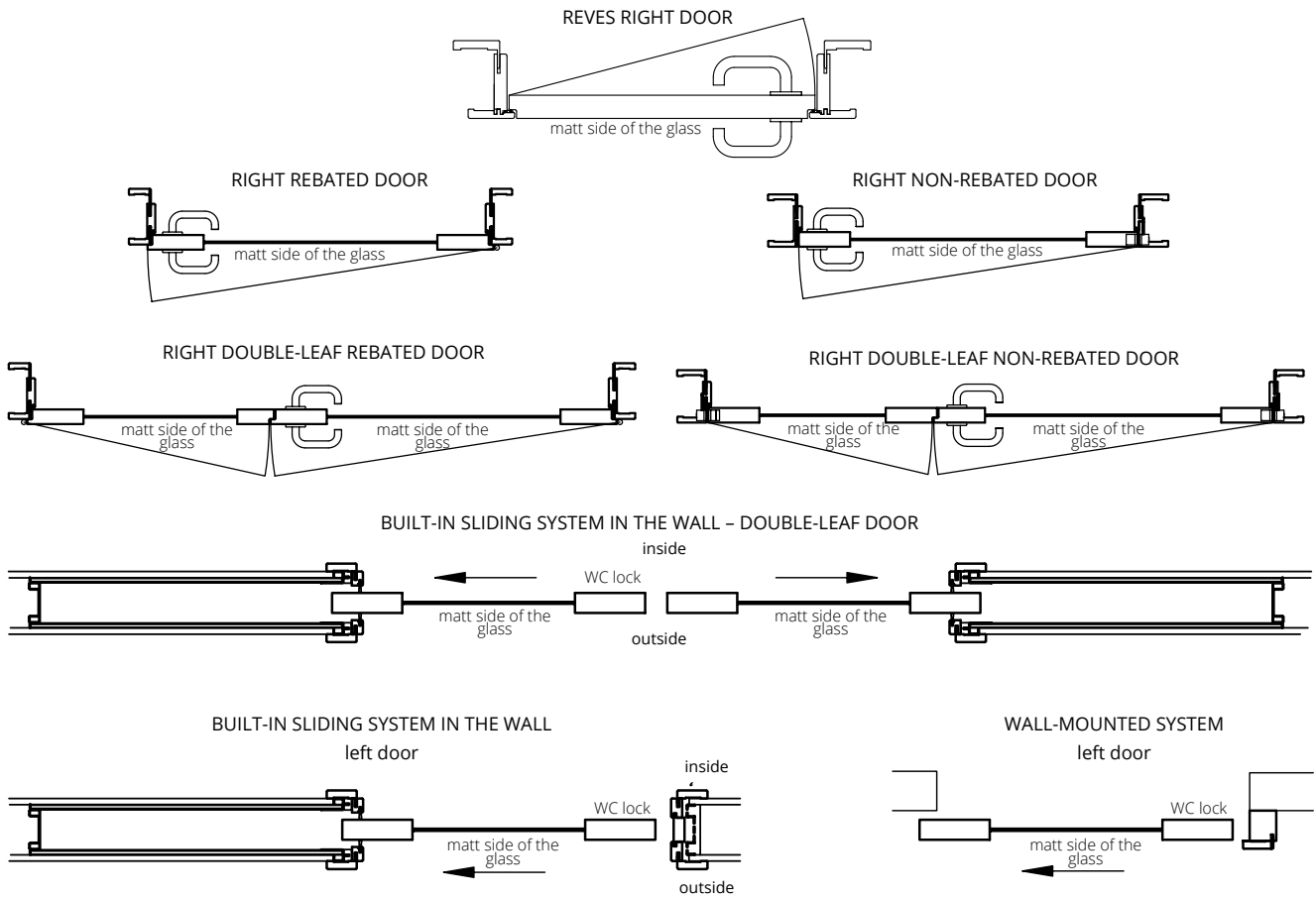

GLAZING DIMENSIONS

(in the opening) of fire doors

FR EI30 SR 32 dB		EI30 PLUS				EI60 PLUS	
Glass dimension in the opening [mm]:		W1S	W2S	W3S	W4S	W1S	W3S
Glass dimension in the opening [mm]:		Glass dimension in the opening [mm]:	Glass dimension in the opening [mm]:	Glass dimension in the opening [mm]:	Glass dimension in the opening [mm]:	Glass dimension in the opening [mm]:	Glass dimension in the opening [mm]:
"60"	-	166x1054	166x1384	166x1054	166x1384	166x860	166x860
"70"	169x1056			266x1054	266x1384		266x860
"80"	269x1056			366x1054	366x1384		366x860
"90"	369x1056			466x1054	466x1384		466x860
"100"	469x1056			566x1054	566x1384		566x860
"110"	-			666x1054	666x1384		566x860

TEMPERED, LAMINATED GLASS

model	version	type of glass	extra charge
Haptic/ Deco/ Cambio / Impuls	V2S/V4SD	tempered glass white/transparent	
		tempered glass brown/graphite	
		VSG 22.1 transparent glass	
		VSG 22.1 white glass	
		VSG 22.1 black glass	
		VSG 33.1 transparent glass	
	V3SD	VSG 33.1 white glass	
		tempered glass brown/graphite	
		VSG 22.1 transparent glass	
		VSG 22.1 white glass	
		VSG 22.1 black glass	
		VSG 33.1 transparent glass	
V5SD	VSG 33.1 white glass		
	tempered glass white/transparent		
	tempered glass brown/graphite		
	VSG 22.1 transparent glass		
	VSG 22.1 white glass		
	VSG 22.1 black glass		
		VSG 33.1 transparent glass	
		VSG 33.1 white glass	

COLOR RANGE



SEE COLOR SAMPLES
IN A LARGER SIZE

ECO TOP

A surface that offers an excellent combination of price and quality, providing the possibility of long-term use in households.

UNI MAT PLUS

REinforced surface characterized by a silky haptic feel and a special coating resistant to fingerprints.

LAMISTONE CPL

Surface with a protective coating against abrasion and the effects of chemicals. Recommended for public utility buildings and used in conditions of intensive use of door joinery, e.g. in hotels, offices.

SILKSTONE

Surface with LAMISTONE CPL characteristics with an additional, unique effect of real wood structure.

SILKSTONE CPL 0.5 mm

Surface with the characteristics and resistance of 0.5 mm CPL LAMINATE with an additional, unique effect of real wood structure. Recommended for public utility buildings and for use in conditions of intensive exploitation of door joinery, e.g. in hotels, offices.

LAMINATED

Highly resistant surface recommended for public utility buildings and used in conditions of intensive exploitation of door joinery, e.g. in hotels, offices. Permissible difference in the shade of door leafs and door frames.

LAMINATED CPL/HPL EGGER

Surface with high resistance to mechanical damage and scratches as well as resistance to moisture and temperature changes. Easy to keep clean. Good durability. Recommended for public utility buildings and used in conditions of intensive exploitation of door joinery, e.g. in hotels, offices.

PREMIUM SURFACES

PAINTED

Ecological acrylic paints, selected colors from the RAL and NCS palettes.

VENEERED

POL-SKONE VENEERED door leafs are coated with ecological UV varnish. It has significantly greater resistance to scratches and the effects of light than standard varnishes, even those applied in several layers. Due to the natural character of veneers, there may be differences in their shades and grain.

VENEERED SILKWOOD

Surface of natural wood veneer coated with ecological paints from the RAL and NCS palettes. Ecological UV varnish increases resistance to scratches and the effects of light.

VENEERED REALWOOD

Surface of natural wood veneer coated with ultra-matt UV varnish with visible wood grain.

ECO TOP

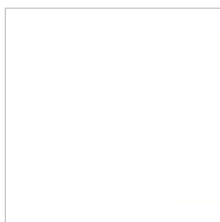

120 white

UNI MAT PLUS



640 graphite



641 titano



642 white

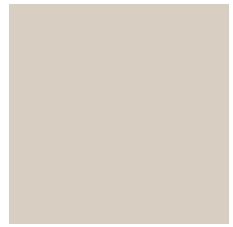

643 beige



644 black

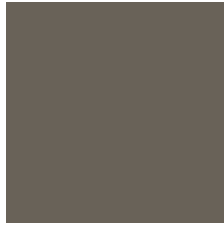

645 lava

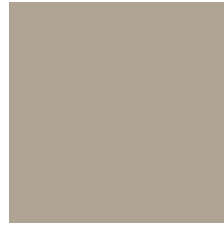

646 stone



648 moss



649 sage

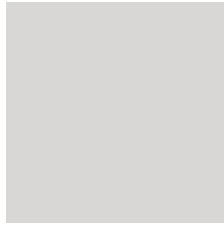

650 grey

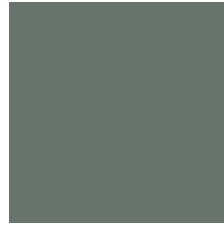

651 verde

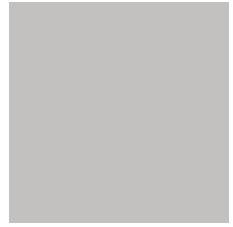

652 platino

UNI MAT PLUS STRUCTURE 3D



670 nero



671 taupe



672 platino

LAMISTONE CPL

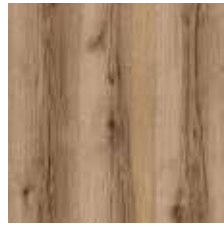

231 Halif oak



241 sandy elm V*



242 grey elm V*



243 Delano oak

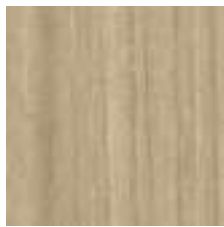

250 Terra oak



260 white oak*



263 premium walnut

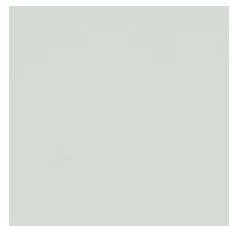

289 grey

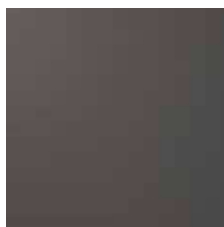

531 anthracite

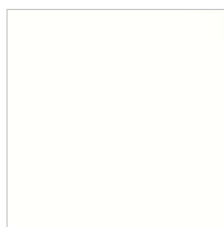

213 super white



233 Salinas oak



234 natural oak

* while stocks last

Actual colors may differ from those shown in the offer. Permissible difference in the shade of door leaves, door frames, and frames.

**LAMISTONE
CPL**



210 filo

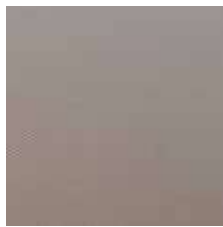

211 fibra

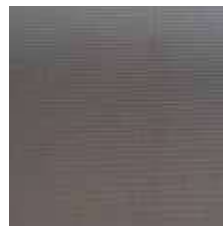

212 lino

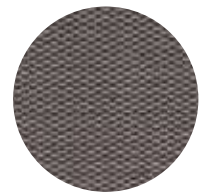

new **unique surface** CPL 0.15
with a structure of linen fabric
interwoven with a metallic sheen

SILKSTONE



230 gran oak

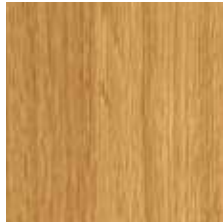

276 Polish oak

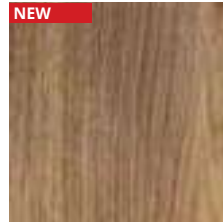

290 Royal oak



293 Royal anthracite



295 Royal merbau



297 Royal nougat

**SILKSTONE
CPL 0.5 mm***



976 Polish oak

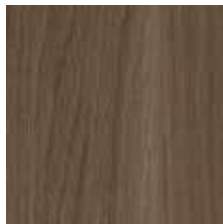

993 Royal anthracite

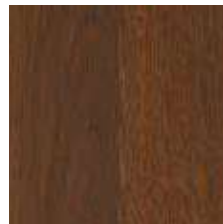

995 Royal merbau



997 Royal nougat

**LAMINATED
CPL 0.2 mm**

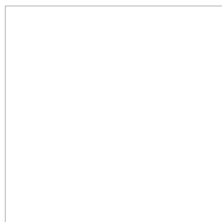

820 white



222 grey



225 terra oak



227 Delano oak

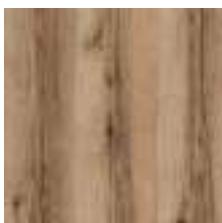

280 Halif oak

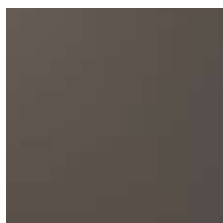

821 anthracite



844 black

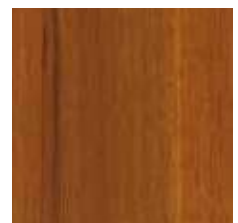

863 premium walnut



833 Salinas OAK



834 natural oak

* colors available after consultation with the Sales Department
Actual colors may differ from those shown in the offer. Permissible difference in the shade of door leaves, door frames, and frames.

**LAMINATED
CPL 0.5 mm***

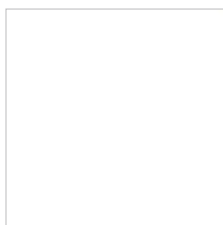

945 white structure

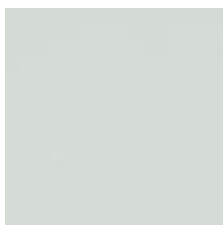

922 grey structure

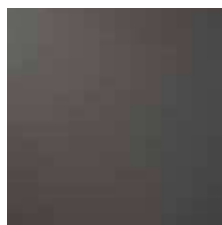

926 anthracite structure



963 premium walnut



946 black structure

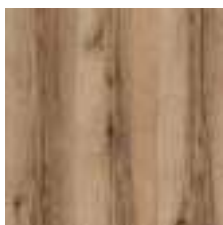

961 Halif oak



933 Salinas OAK



934 natural oak



825 terra oak

**LAMINATED
CPL EGGER
0.2 mm
GROUP A**



574 cashmere ST9

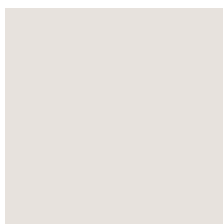

575 grey ST9



576 alpine white ST9

**LAMINATED
CPL EGGER
0.2 mm
GROUP B**



570 light Vincenza oak ST12



571 Vincenza oak ST12



572 natural Kendal oak ST12

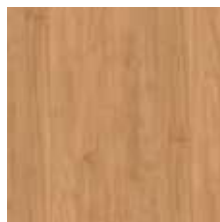

573 oiled Kendal oak ST12

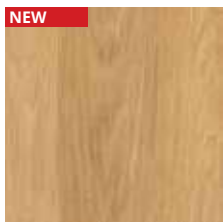

577 natural hickory ST10

**LAMINATED
HPL 1 mm
FUNDERMAX***

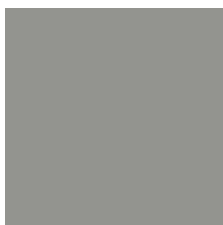

H20 0075

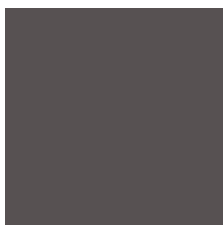

H21 0077

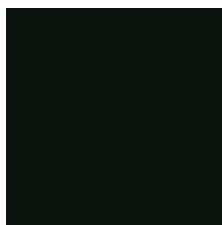

H22 0080

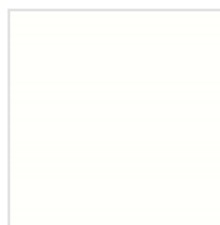

H23 2286

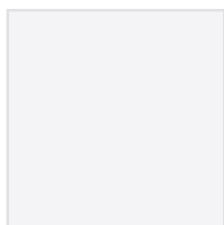

H24 0091

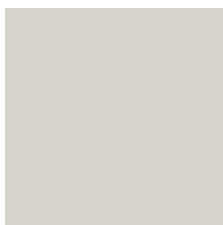

H25 0741

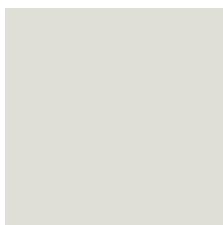

H26 1203



H27 0070



H28 0125

* colors available after consultation with the Sales Department
Actual colors may differ from those shown in the offer. Permissible difference in the shade of door leaves, door frames, and frames.

**LAMINATED
HPL EGGER
0.8 mm
GROUP A**

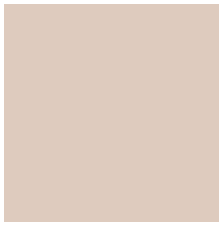

H54 cashmere ST9

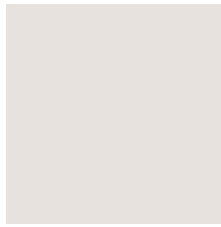

H55 grey ST9



H56 alpine white ST9

**LAMINATED
HPL EGGER
0.8 mm
GROUP B**



H50 light Vincenza oak ST12



H51 Vincenza oak ST12



H52 natural Kendal oak ST12



H53 oiled Kendal oak ST12



H57 natural hickory ST10

**VENEERED
GROUP A**



312 limba

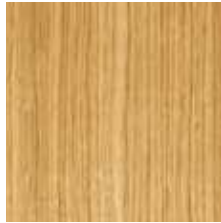

334 European oak

**VENEERED
GROUP B**



323 rustic oak



340 ebony

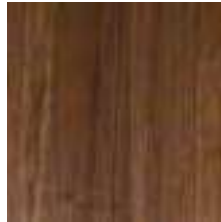

390 natural walnut



404 dark walnut

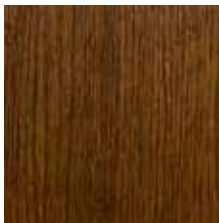

405 light walnut



421 cappuccino

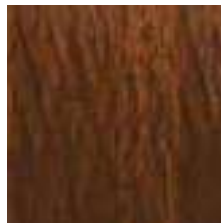

422 mocha



424 teak

**VENEERED
GROUP C**



370 whitewashed oak

VENEERED GROUP D



313 classic oak

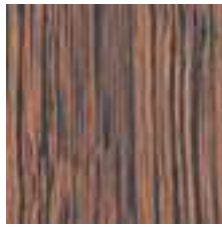

460 makassar

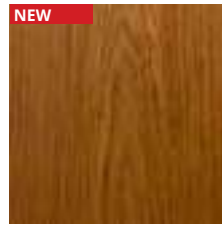

461 caramel oak

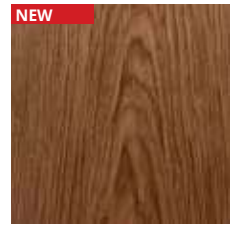

462 truffle oak

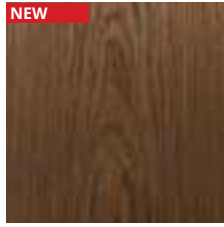

463 chocolate oak



STRIPED
DOOR FRAMES

HALF-FLADER
DOOR LEAFS

UNIQUENESS OF THE GRAIN OAK VENEER

POL-SKONE offers the most extensive range of veneered door leaves, for the production of which natural veneers are used, including oak veneer. The quality of oak veneer, irregular grain pattern, rich palette of shades and natural beauty are the undeniable advantages of veneered doors.

VENEERED SILKWOOD



450 white matt



451 black matt



452 grey matt RAL 7047



453 indigo RAL 5011



454 sage matt
NCS S 4010-G50Y



455 beige
NCS S 2005-Y50R



456 grey RAL 7038

**VENEERED
REALWOOD**



470 nabucco matt



471 toska matt

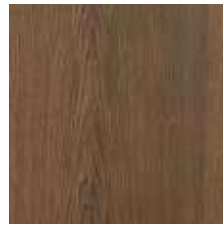

472 traviata matt



473 kastano matt

PAINTED

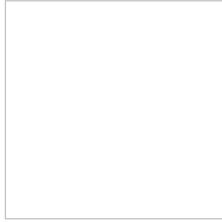

001 white (RAL 9003)

**MONO1
MAT**

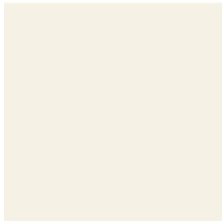

OMA RAL 9010 matt

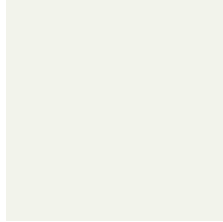

OMB RAL 9016 matt

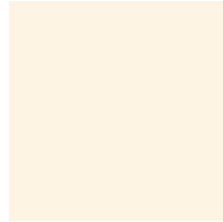

OME RAL 9001 matt



OMF RAL 9002 matt

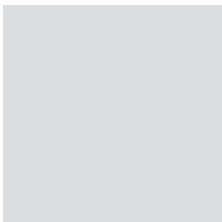

OM5 grey matt RAL 7047

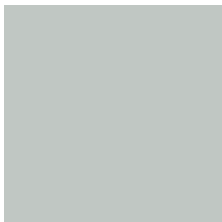

OMG RAL 7035 matt



OMH RAL 7004 matt

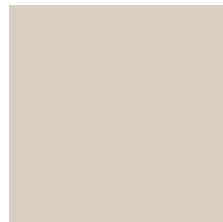

**OM6 beige matt
NCS S 2005 Y50R**

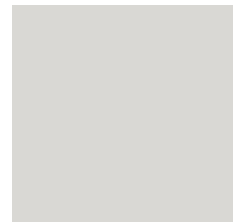

**OMD light beige matt
NCS S1502-Y50R**

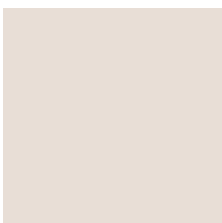

**OMC sand grey matt
NCS S 1002-Y50R**

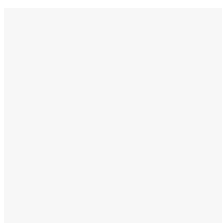

000 NCS S 0500-N white

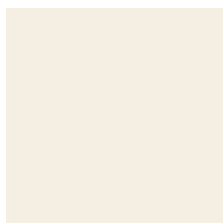

OMI NCS S 0502-Y matt

**MONO2
MAT**



0M7 sage matt
NCS S 4010-G50Y



0M4 indigo matt
RAL 5011



0M1 sky blue matt
RAL 5014



0MJ RAL 1015 matt

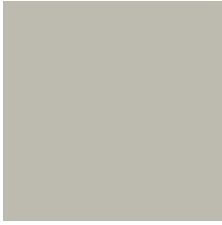

0MK RAL 7044 matt



0ML RAL 7038 matt

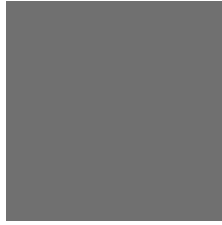

0ND RAL 7037 matt

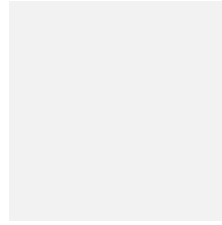

0MM NCS S 0300-N matt

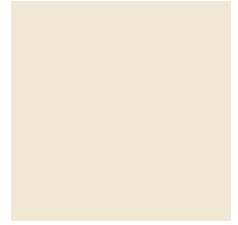

0MN NCS s 1502-Y matt

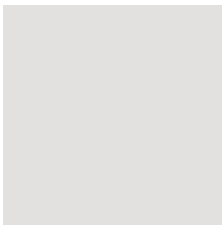

0MO NCS S 1000-N matt

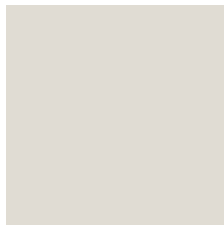

0MP NCS S 1002-Y matt

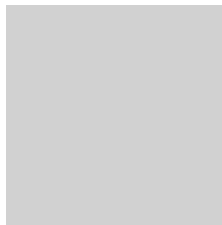

0MQ NCS S 1500-N matt

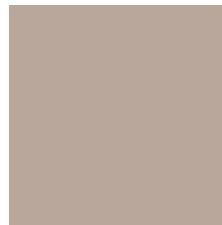

0MR NCS S 3005-Y50R matt

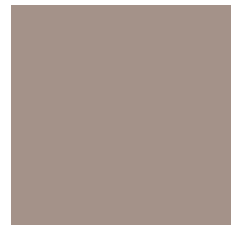

0MS NCS S 4005-Y50R matt

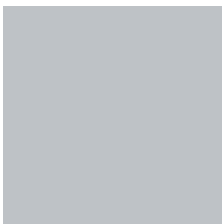

0MT NCS S 2005-R80B matt

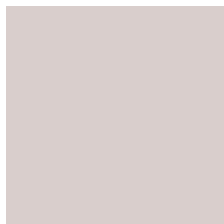

0MU NCS S 1502-R matt

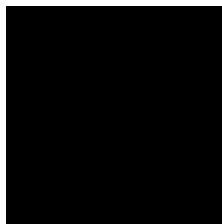

002 BLACK black
RAL 9005

**MONO3
MAT**



0N1 NCS S 8000N matt

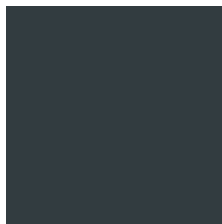

0N2 RAL 7016 matt

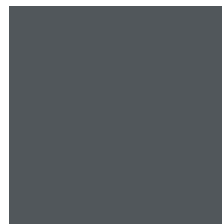

0N3 RAL 7024 matt



0N4 NCS S 8500N matt

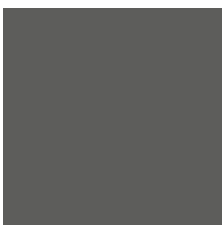

0N6 NCS S 7000N matt

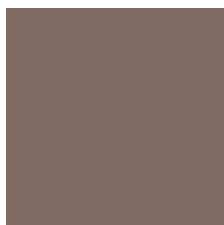

0N7 NCS S 6005 Y50R matt



0N8 RAL 1019 matt

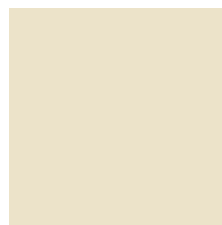

0N9 RAL 1013 matt

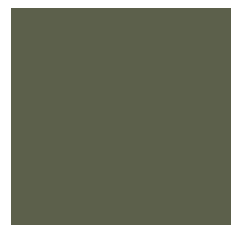

0NA RAL 6003 matt



0NB RAL 6013 matt



0NC RAL 6012 matt

COLOR RANGE

STEEL DOORS AND METAL DOOR FRAMES

Standard color range available in standard semi-matt finish

COLORS OF METAL DOOR FRAMES

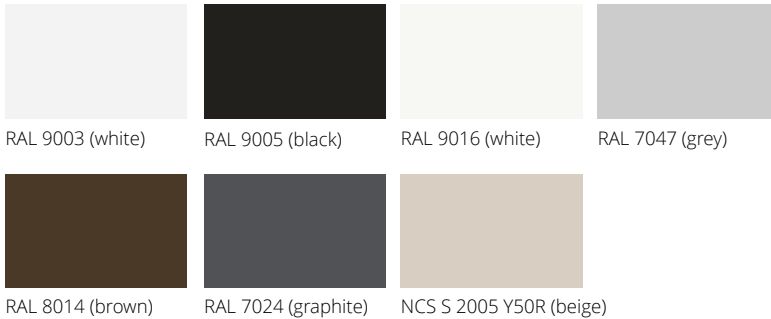

RAL COLOR RANGE EXTRA CHARGE TABLE no possibility to manufacture door frames in the NCS color range

extra charge per door frame			
Color range group	(1-5 pcs.)	(6-10 pcs.)	(over 10 pcs.)
GROUP I			
GROUP II			
GROUP III			
GROUP IV			
GROUP V			

EXTRA CHARGE TABLE – STRUCTURES

extra charge to the base price of the metal door frame	
rebated system	
non-rebated system	
HARMONY in RAL 9003, RAL 9005 color	

COLORS OF GALIO / STALIO STEEL DOORS

STEEL STRUCTURE GROUP 1



OS1 RAL 9003

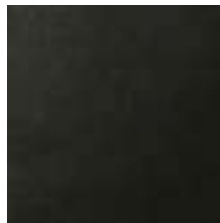

OS2 RAL 9005



OS0 anthracite (glitter effect)

STEEL STRUCTURE GROUP 2



OS3 copper (glitter effect)



OS4 cashmere (glitter effect)

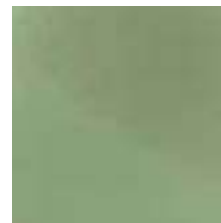

OS5 sage

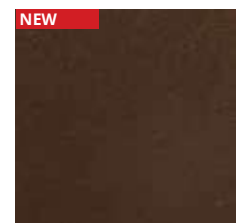

OS7 mocha

RAL COLOR RANGE PALETTE (concerns metal door frames, aluminum door frames and aluminum strips)

GROUP I

1000 1001 1002 1011 1013 1015 1019 1020 3009 4001 5000 5001 5004 5005 5007 5008 5009 5010 5011 5013 5014 5017 5019 5020 5021 5022 5023 5024 6000 6003
6004 6005 6006 6007 6008 6011 6012 6013 6014 6015 6019 6020 6026 6027 6033 6034 7000 7001 7002 7003 7004 7005 7006 7008 7009 7010 7011 7012 7013 7015
7016 7021 7022 7023 7026 7030 7031 7032 7033 7034 7035 7036 7037 7038 7039 7040 7042 7043 7044 7045 7046 8000 8001 8002 8003 8004 8007 8011 8012 8015
8017 8019 8022 8023 8024 8025 8028 9001 9002 9010 1024HR 6021HR

GROUP II

1014 3000 3001 3002 3004 3007 3011 3013 3016 4002 4008 5002 5003 5012 5015 5018 6017 6022 6025 6029 9018 3031HR4005HR4006HR6002HR8008HR

GROUP III

3003 3005 3020 3022 6010 6018 6024 1024HR4004HR4010HR6032HR

GROUP IV

3012 3014 6001 6028 3027HR4003HR4007HR6037HR

GROUP V

1003 1004 1005 1006 1016 1017 1018 1021 1023 1027 1032 1033 1034 1037 2000 2001 2002 2004 2009 2010 2011 2012 3018 1027HR1028HR2003HR2008HR3028HR 9006

The RAL color range of metal door frames and aluminum door frames differs from the RAL color range of painted door leaves due to the different material application technology.

HPL LAMINATES

HPL laminate, thickness 1.0 mm, FH structure with antibacterial coating.

Laminate code	Approximate RAL equivalent (suggested, not 100% compliant)	Wooden door frame, DIN and edge	Metal door frame	Extra charge
				width "60"- "100" height standard
				width "60"- "100" height above standard
				width "110"- "120" height standard and above standard
0075 FH	RAL 7037	painted door frame, painted edge	RAL 7037, painted edge	
0077 FH	RAL 7024 / RAL 7015	painted door frame, painted edge or Lamistone 531 option, CPL 0.2 821, anthracite edge	RAL 7024 / RAL 7015, painted edge	
0080 FH	RAL 9005	painted door frame, painted edge or CPL 0.2 844 option, black edge	RAL 9005, painted edge	
2286 FH	RAL 9016	painted door frame, painted edge, CPL 0.2 white 820 option, white edge	RAL 9016, painted edge	up to 1 pc. door leafs in CPL 0.2 surface
0741 FH	RAL 7035	painted door frame, painted edge or Lamistone 289 option, CPL 0.2 222, grey edge	RAL 7035, painted edge	up to 1 pc. door leafs in CPL 0.2 surface
1203 FH	RAL 7047	none	RAL 7047, painted edge	up to 1 pc. door leafs in CPL 0.2 surface
0070 FH	RAL 7016	no match	RAL 7016, painted edge	
0125 natural oak		laminated door frame in UNI colors, edge in UNI colors	all UNI colors	
0091 FH	RAL 9003	painted door frame, painted edge Lamistone 213 option, white edge		individual quotation

COLOR RANGE MATCHING OF LAMINATES TO METAL DOOR FRAMES

UNI MAT PLUS COLOR	RAL/NCS S EQUIVALENT (SUGGESTED) NOT 100% COMPATIBLE
WHITE 642	RAL 9003
BEIGE 643	NCS S 2005 Y50R
GRAPHITE 640	RAL 7024
TITANO 641	RAL 7037
BLACK 644	RAL 9005
LAVA 645	7013 or 7006
STONE 646	RAL 1019
MOSS 648	RAL 6012
SAGE 649	NCS S 4010 G50Y
VERDE 651	NCS S 6005 G20Y
GRAY 650	RAL 7047
PLATINO 652	NO MATCH

	CPL 0.15	CPL 0.2	CPL 0.5	color range metal door frame
light gray	code 289	code 222	code 922	RAL 7035
anthracite	code 531	code 821	code 926	RAL 7024
black	-	code 844	code 946	RAL 9005
white	-	code 820	code 945	RAL 9016
super white	code 213	-	-	RAL 9003

POSSIBILITY OF MAKING THE EDGE IN THE COLOR RANGE PAINTED RAL

applies to laminated doors (extra charge for 1 piece)
from 1 to 5 pcs., above 5 pcs.

DOUBLE-COLOR DOORS



double-color door leaf, single-color door frame

double-color door leaf, double-color door frame

POSSIBILITY OF MAKING DOUBLE-COLOR DOORS

(INTERIOR AND TECHNICAL DOORS) Only panel construction, does not apply to stile and rail construction. Colors only from the same color range group, e.g. ECO TOP+ECO TOP, LAMISTONE+LAMISTONE, CPL 0.2+CPL 0.2, HPL+HPL

double-color door leaf / single-color door frame	without extra charge
double-color door leaf / double-color door frame	to the price of the door

FIXED DOOR FRAME

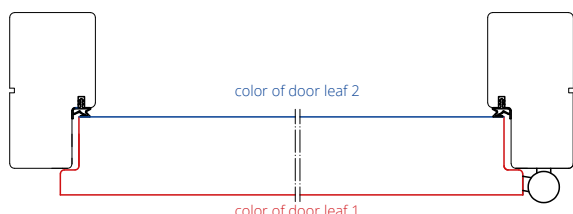

double-color door leaf / single-color door frame

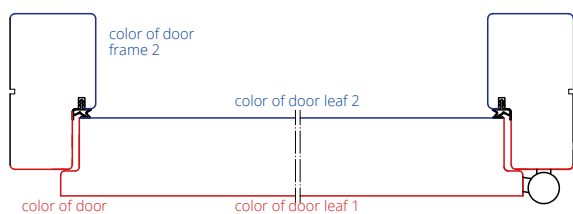

double-color door leaf / double-color door frame

ADJUSTABLE DOOR FRAME

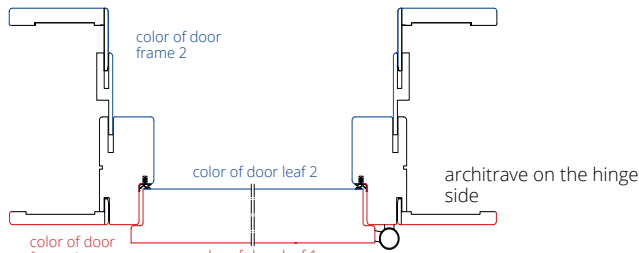

double-color door leaf / double-color door frame

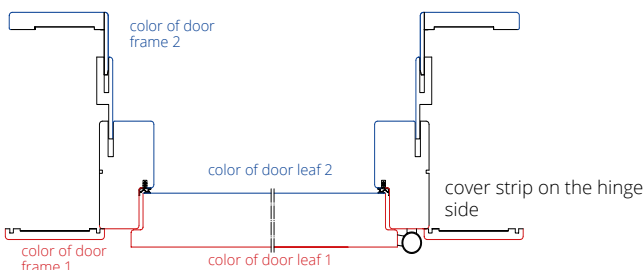

STANDARD PARAMETERS OF POL-SKONE DOORS

STRENGTH CLASS MECHANICAL	ANTI-BURGLARY			FIRE RESISTANCE		SMOKE TIGHTNESS	SOUND INSULATION				SPECIALIST		MECHANICAL DURABILITY					
	class 2	class 3	class 4	RC2 class	RC3 class	class C	EI30	EI60	Sa, S ₂₀₀	27 dB	32 dB	37 dB	42 dB	climate class 3	X-RAY	20,000 cycles	50,000 cycles	100,000 cycles

INTERIOR

PANEL CONSTRUCTION DOORS	●	○	○	○	○	○	○	○	○	○	○	○	○	○	○	○	○	○	○	○
PANEL CONSTRUCTION DOORS	○	●	○	○	○	○	○	○	○	○	○	○	○	○	○	○	○	○	○	○
STILE AND RAIL CONSTRUCTION DOORS	●	○	○	○	○	○	○	○	○	○	○	○	○	○	○	○	○	○	○	○
DECO INVEST single-leaf - p. 180	○	●	●	○	○	○	○	○	○	○	○	○	○	○	○	○	○	○	○	○
DECO INVEST double-leaf - p. 181	●	○	○	○	○	○	○	○	○	○	○	○	○	○	○	○	○	○	○	○

INTERIOR ENTRANCE

HARMONY INVEST- p. 16 HARMONY INVEST PRO - p. 18	○	●	●	○	○	○	○	○	○	○	○	○	○	○	○	○	○	○	○	○
B-30, B-30 INVEST - p. 204, 206	○	○	●	○	●	○	●	○	○	○	○	○	○	○	○	○	○	○	○	○
C-30 - p. 204	○	○	●	○	●	○	●	○	○	○	○	○	○	○	○	○	○	○	○	○
CERBER PLUS RC2 - p. 214	○	●	○	○	○	○	○	○	○	○	○	○	○	○	○	○	○	○	○	○
RC3, RC3 INVEST - p. 212	○	○	●	○	○	○	○	○	○	○	○	○	○	○	○	○	○	○	○	○
CERBER PLUS - p. 216	○	●	○	○	○	○	○	○	○	○	○	○	○	○	○	○	○	○	○	○
RC3 INVEST 37 dB - p. 210	○	○	●	○	○	○	○	○	○	○	○	○	○	○	○	○	○	○	○	○
RC3 INVEST SR 37 EI30 - p. 208	○	○	●	○	○	○	○	○	○	○	○	○	○	○	○	○	○	○	○	○

TECHNICAL

G46 - p. 182	●	○	○	○	○	○	○	○	○	○	○	○	○	○	○	○	○	○	○	○
FR EI30 - p. 224	○	●	○	○	○	○	○	○	○	○	○	○	○	○	○	○	○	○	○	○
FR EI30 SR37 dB - p. 222	○	●	○	○	○	○	○	○	○	○	○	○	○	○	○	○	○	○	○	○
FR EI30 SR 42 dB - p. 220	○	●	○	○	○	○	○	○	○	○	○	○	○	○	○	○	○	○	○	○
FR EI30 SR 42 dB DM - p. 220	○	●	○	○	○	○	○	○	○	○	○	○	○	○	○	○	○	○	○	○
EI30 PLUS - p. 226	○	●	○	○	○	○	○	○	○	○	○	○	○	○	○	○	○	○	○	○
EI60 PLUS - p. 230	○	●	○	○	○	○	○	○	○	○	○	○	○	○	○	○	○	○	○	○
AKUSTIK 42 dB - p. 198	○	○	●	○	○	○	○	○	○	○	○	○	○	○	○	○	○	○	○	○
AKUSTIK SEKURO 42 dB - p. 198	○	○	●	○	○	○	○	○	○	○	○	○	○	○	○	○	○	○	○	○
SR 37 dB - p. 196	○	○	●	○	○	○	○	○	○	○	○	○	○	○	○	○	○	○	○	○
TYPE A - p. 192	●	○	○	○	○	○	○	○	○	○	○	○	○	○	○	○	○	○	○	○
TYPE B - p. 192	●	○	○	○	○	○	○	○	○	○	○	○	○	○	○	○	○	○	○	○
TYPE A DUO - p.192	●	○	○	○	○	○	○	○	○	○	○	○	○	○	○	○	○	○	○	○
TYPE B DUO - p. 192	●	○	○	○	○	○	○	○	○	○	○	○	○	○	○	○	○	○	○	○
HIGRO - p. 188	●	○	○	○	○	○	○	○	○	○	○	○	○	○	○	○	○	○	○	○
GAMMA - p. 190	○	●	○	○	○	○	○	○	○	○	○	○	○	○	○	○	○	○	○	○

* HARMONY INVEST PRO ODW

● available ○ unavailable ◐ optional

ADDITIONAL INFORMATION



Authorized installation teams

You will find here the addresses of authorized installation teams.



Installation instructions

See installation instruction videos.

COLOR RANGE OF INTERIOR DOORS

AVAILABLE COLOR RANGE INTERIOR DOORS

	raw door leaf for self-finishing	ECO TOP	LAMISTONE	SILKSTONE	UNI MAT PLUS	UNI MAT PLUS 3D STRUCTURE	LAMINATED CPL / HPL	EGGER CPL / HPL LAMINATE	PAINTED WHITE RAL 9003	MONO1 MAT	MONO2 MAT	MONO3 MAT	PAINTED - STEEL	VENEERED - GROUP A	VENEERED - GROUP B	VENEERED - GROUP C	VENEERED - GROUP D	SILKWOOD	REALWOOD
ADORE - p. 96	-	-	●	-	●	-	-	-	-	-	-	-	-	-	-	-	-	-	-
ARCO - p. 58	-	●	●	●	-	-	-	-	-	-	-	-	-	-	-	-	-	-	-
CAMBIO - p. 122	-	-	-	-	-	-	-	●	●	●	●	-	-	-	-	-	-	-	-
CREATO - p. 92	-	-	-	-	●	-	-	-	-	-	-	-	-	-	-	-	-	-	-
DECO - p. 86	-	-	-	-	-	-	●	●	-	-	-	-	-	-	-	-	-	-	-
DECO EGGER - p. 88	-	-	-	-	-	-	●	●	-	-	-	-	-	-	-	-	-	-	-
DECO LUX - p. 152	-	-	-	-	-	-	-	-	-	-	-	-	-	●	●	●	●	●	●
EGRO - p. 54	-	-	-	-	●	●	-	-	-	-	-	-	-	-	-	-	-	-	-
EMPORE - p. 98	-	-	-	-	●	-	-	-	-	-	-	-	-	-	-	-	-	-	-
ESPINA - p. 154	-	-	-	-	-	-	-	-	-	-	-	-	-	●	●	-	-	-	-
ESTATO - p. 126	-	-	-	-	-	-	-	●	●	-	-	-	-	-	-	-	-	-	-
ESTATO LUX - p. 160	-	-	-	-	-	-	-	-	-	-	-	-	-	●	●	-	●	-	●
ESTO - p. 56	-	-	●	●	●	-	-	-	-	-	-	-	-	-	-	-	-	-	-
ETIUDA - p. 104	-	-	●	●	-	-	-	-	-	-	-	-	-	-	-	-	-	-	-
FIORD - p. 134	-	-	-	-	-	-	-	●	●	●	●	-	-	-	-	-	-	-	-
FORTIMO - p. 74	-	-	●	●	●	-	-	-	-	-	-	-	-	-	-	-	-	-	-
FORTIMO LUX - p. 144	-	-	-	-	-	-	-	-	-	-	-	-	-	●	●	●	●	-	●
FORTO - p. 64	-	-	●	●	●	-	-	-	-	-	-	-	-	-	-	-	-	-	-
GALIO - p. 22	-	-	-	-	-	-	-	-	-	-	-	-	●	-	-	-	-	-	-
GALIO PIVOT - p. 28	-	-	-	-	-	-	-	-	-	-	-	-	●	-	-	-	-	-	-
HAPTIC - p. 82	-	-	-	-	●	-	-	-	-	-	-	-	-	-	-	-	-	-	-
HARMONY INVEST - p. 16	●	-	●	●	●	-	●	●	●	●	●	-	-	●	●	●	●	●	●
HARMONY INVEST PRO - p. 18	●	-	●	●	●	-	●	●	●	●	●	-	-	●	●	●	●	●	●
HARMONY MIRROR - p. 14	●	-	●	●	●	-	●	●	●	●	●	-	-	●	●	●	●	●	●
HARMONY SYSTEM POL-SKONE - p. 12	●	-	●	●	●	-	●	●	●	●	●	-	-	●	●	●	●	●	●
IMPULS - p. 84	-	-	●	●	-	-	-	-	-	-	-	-	-	-	-	-	-	-	-
INTERSOLID - p. 146	-	-	-	-	-	-	-	-	-	-	-	-	-	●	●	●	●	-	●
INTERSOLID II - p. 148	-	-	-	-	-	-	-	-	-	-	-	-	-	●	●	●	●	-	●
INVERNO - p. 90	-	-	●	●	●	-	-	-	-	-	-	-	-	-	-	-	-	-	-
KINGSTONE - p. 150	-	-	-	-	-	-	-	-	-	-	-	-	-	-	-	-	-	●	-
LAURA - p. 68	-	-	●	●	-	-	-	-	-	-	-	-	-	-	-	-	-	-	-
LUMEN - p. 164	-	●	●	●	●	●	●	●	●	●	●	-	-	●	●	●	●	●	●
LUMEN LOFT - p. 166	-	●	●	●	●	●	●	●	●	●	●	-	-	●	●	●	●	●	●
LUMO - p. 26	-	-	-	-	-	-	-	-	-	-	-	-	●	-	-	-	-	-	-
MAESTO - p. 100	-	-	-	-	●	-	-	-	-	-	-	-	-	-	-	-	-	-	-
MAGRO - p. 66	-	-	●	●	●	-	-	-	-	-	-	-	-	-	-	-	-	-	-
MODENA - p. 118	-	-	-	-	-	-	-	●	●	●	●	-	-	-	-	-	-	-	-
MODERN - p. 108	-	-	-	-	-	-	-	●	●	●	●	-	-	-	-	-	-	-	-
MODESTO - p. 112	-	-	-	-	-	-	-	●	●	●	●	-	-	-	-	-	-	-	-
MODO - p. 52	-	-	-	-	●	●	-	-	-	-	-	-	-	-	-	-	-	-	-
MONA - p. 78	-	-	●	●	●	-	-	-	-	-	-	-	-	-	-	-	-	-	-
PALAZZO - p. 114	-	-	-	-	-	-	-	●	●	●	●	-	-	-	-	-	-	-	-
PASSO - p. 80	-	-	●	●	-	-	-	-	-	-	-	-	-	-	-	-	-	-	-
PRINCESTONE - p. 120	-	-	-	-	-	-	-	●	●	●	●	-	-	-	-	-	-	-	-
RIFLO - p. 138	-	-	-	-	-	-	-	●	●	●	●	-	-	-	-	-	-	-	-
ROYALE - p. 136	-	-	-	-	-	-	-	●	●	●	●	-	-	-	-	-	-	-	-
SALEA - p. 102	-	-	●	●	-	-	-	-	-	-	-	-	-	-	-	-	-	-	-
SAMOS - p. 62	-	-	●	●	-	-	-	-	-	-	-	-	-	-	-	-	-	-	-
SEDO - p. 48	-	-	-	-	●	●	-	-	-	-	-	-	-	-	-	-	-	-	-
SEMPRE - p. 70 and 72	-	-	●	●	●	-	-	-	-	-	-	-	-	-	-	-	-	-	-
SEMPRE LUX - p. 140 and 142	-	-	-	-	-	-	-	-	-	-	-	-	-	●	●	●	●	-	●
SENTO - p. 130	-	-	-	-	-	-	-	●	●	●	●	-	-	-	-	-	-	-	-
FOLDING - p. 162	-	●	●	●	●	●	●	●	●	●	●	-	-	●	●	●	●	●	●
SLIM - p. 76	-	-	●	●	●	-	-	-	-	-	-	-	-	-	-	-	-	-	-
SONATA - p. 94	-	-	●	●	●	-	-	-	-	-	-	-	-	-	-	-	-	-	-
SONATA LUX - p. 158	-	-	-	-	-	-	-	-	-	-	-	-	-	●	-	-	-	-	●
STALIO - p. 34	-	-	-	-	-	-	-	-	-	-	-	-	●	-	-	-	-	-	-
SUBITO - p. 124	-	-	-	-	-	-	-	●	●	●	●	-	-	-	-	-	-	-	-
SUBLIME - p. 132	-	-	-	-	-	-	-	●	●	●	●	-	-	-	-	-	-	-	-
TEO - p. 156	-	-	-	-	-	-	-	●	●	●	●	-	-	●	-	-	-	-	-
TIARA - p. 128	-	-	-	-	-	-	-	●	●	●	●	-	-	-	-	-	-	-	-
UNITO - p. 60	-	-	-	-	●	●	-	-	-	-	-	-	-	-	-	-	-	-	-
VERI - p. 50	-	-	-	-	●	●	-	-	-	-	-	-	-	-	-	-	-	-	-
VERTIGO - p. 116	-	-	-	-	-	-	-	●	●	●	●	-	-	-	-	-	-	-	-
VILANO - p. 110	-	-	-	-	-	-	-	●	●	●	●	-	-	-	-	-	-	-	-
VISIO - p. 40	-	-	-	●	●	-	-	-	-	-	-	-	-	-	-	-	-	-	-
VISIO LUX - p. 42	-	-	-	-	-	-	-	-	-	-	-	-	-	●	-	-	●	-	●
VISIO M - p. 44	-	-	-	●	●	-	-	-	-	-	-	-	-	●	-	-	●	-	●
ZENN - p. 106	-	-	●	-	-	-	-	-	-	-	-	-	-	-	-	-	-	-	-

POL-SKONE Sp. z o.o.

8 Hanki Ordonówny St.; 20-328 Lublin

tel.: +48 81 728 52 00

fax +48 81 744 24 89

pol-skone@pol-skone.eu

EXPORT
DEPARTMENT



DOWNLOAD THE CURRENT CATALOG USING THE QR CODE

CATALOG
OF PRODUCTS



CARPENTRY
EXTERNAL



DOOR CATALOG
STEEL



LookBook

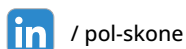
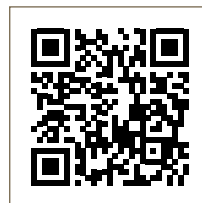

/ pol-skone



/ DiscoverBetterInterior



/ pol_skone



pol-skone.pl

This Product Catalog is valid **from 01.02.2026** (as of this date, previous POL-SKONE catalogs become invalid).

This publication does not constitute an offer within the meaning of the law and is for informational purposes only. The manufacturer reserves the right to make changes.

SYSTEMS



REBATED SYSTEM
The door leaf has a rebate (notch, groove) that overlaps the door frame

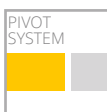

PIVOT SYSTEM
frameless system with the possibility of opening in both directions



NON-REBATED SYSTEM
The straight edge of the door leaf creates a uniform surface with the door frame



HARMONY SYSTEM
system with a door frame concealed in the wall



REVES SYSTEM
The door leaf has a reverse rebate (notch, groove) that creates a uniform surface with the door frame

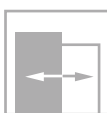

SLIDING SYSTEM
possibility of use in a sliding system

DIMENSIONS

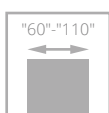

SINGLE-LEAF DOOR
(dimension range)



DOUBLE-LEAF DOOR
(dimension range)

PARAMETERS



PROPERTIES
sound insulation

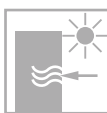

PROPERTIES
thermal transmittance



PROPERTIES
fire resistance



PROPERTIES
smoke tightness



PROPERTIES
anti-burglary



PROPERTIES
resistance to climatic conditions



PROPERTIES
mechanical class I, II, III or IV



X-RAY



PROPERTIES
protection of the lower edge of the door leaves with a special preservative against moisture

CONSTRUCTION



DOOR LEAF CONSTRUCTION
wooden stile and rail, filling with a "honeycomb" structure layer



DOOR LEAF CONSTRUCTION
laminated wood



DOOR LEAF CONSTRUCTION
wooden stile and rail, perforated chipboard filling

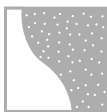

DOOR LEAF CONSTRUCTION
high-quality MDF board



DOOR LEAF CONSTRUCTION
wooden stile and rail, solid chipboard filling



DOOR LEAF CONSTRUCTION
special POL-SKONE construction

ECO TOP ★ ★ ★ ★ ★ It performs excellently in everyday use in households.

UNI MAT PLUS ★ ★ ★ ★ ★
LAMISTONE
SILKSTONE Laminates with a protective coating against abrasion and the effects of chemical agents. UNI MAT PLUS is a laminate with a silky haptic feel and a coating resistant to fingerprints.

SILKSTONE CPL ★ ★ ★ ★ ★
CPL LAMINATE Laminates recommended for public utility buildings and for use in conditions of intensive exploitation of door joinery. Available in thicknesses of 0.2 mm and 0.5 mm

HPL LAMINATE ★ ★ ★ ★ ★ Extremely hard and durable surface with high resistance to use. This type of laminate is also used to produce kitchen countertops.

PREMIUM SURFACES

PAINTED ★ ★ ★ ★ ★
MONO1 MAT
MONO2 MAT
MONO3 MAT Ecological paints from the RAL and NCS palettes in a three-layer painting system ensure color durability for many years. Matt or semi-matt surfaces.

VENEERED ★ ★ ★ ★ ★ Natural veneer coated with ecological UV lacquer, which ensures color durability and scratch resistance.

SILKWOOD ★ ★ ★ ★ ★ Natural veneer coated with ecological paints from the RAL and NCS palettes.

REALWOOD ★ ★ ★ ★ ★ Natural veneer coated with ultra-matt UV lacquer.

HOW TO PRICE DOORS

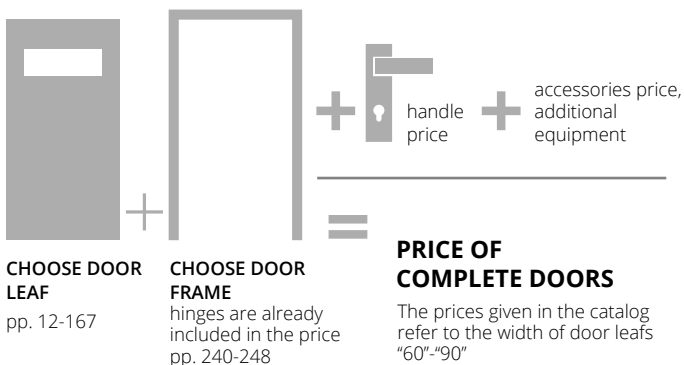

RIGHT OR LEFT DOOR?

right door

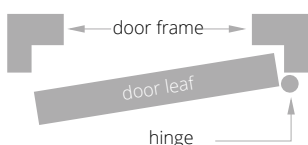

left door

